

Rivet Type Banana Plug with Turret

Model# 3261

Excellent for riveting to panels or boards. Solder turret for rapid attachment of wires.

Fits standard 0.166in (4.22mm) dia. banana jack.

Material: *Banana Plug Body:* brass; *Spring:* beryllium copper; *Finish:* nickel plating.

Rating: For CE compliance and for personal safety, do not hold in hand when voltages exceed 33 Vrms/70 Vdc. Maximum voltage for *hands free use:* 5000 Vdc. Do not use on circuits where transient stresses can exceed the rated voltage. 15A.

Sold in pkgs. of 10.

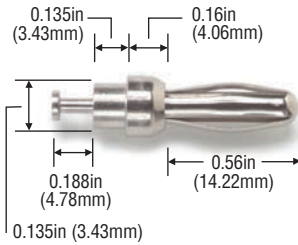

Banana Plug with Threaded Stud and Solder Lug

Model#	Thread
3263	6-32 x .50in (12.70mm)
3264	8-32 x .50in (12.70mm)
4512	8-32 x .63in (16.00mm)

Fits standard 0.166in (4.22mm) dia. banana jack.

Material: *Banana Plug Body:* brass; *Spring:* beryllium copper; *Finish:* nickel plating.

Rating: For CE compliance and for personal safety, do not hold in hand when voltages exceed 33 Vrms/70 Vdc. Maximum voltage for *hands free use:* 5000 Vdc. Do not use on circuits where transient stresses can exceed the rated voltage. 15A.

Sold unassembled, in pkgs. of 10.

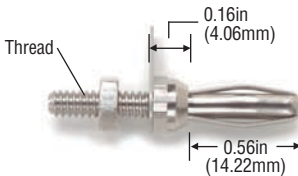

Insulated Banana Plug and Jack with Flexible Boot, Solder or Crimp

Model#	Accepts wire AWG	Type	Mates with...
5167-*	22, 20, 18	Jack	Plug 5169
5168-*	16, 14		Plug 5170
5169-*	22, 20, 18	Plug	Jack 5167
5170-*	16, 14		Jack 5168

Ideal for making patch cords or field repairs. Snap-on flexible PVC boot allows wire to be crimped or soldered to banana plug or jack.

Fits standard 0.166in (4.22mm) dia. banana jack.

Material: *Boot:* Banana Plug Body: brass; *Spring:* beryllium copper; *Finish:* nickel plating; *Jack:* nickel plated brass.

Rating: For CE compliance and for personal safety, do not hold in hand when voltages exceed 33 Vrms/70 Vdc. Maximum voltage for *hands free use:* 5000 Vdc. Do not use on circuits where transient stresses can exceed the rated voltage. 15A, +122°F (+50°C) max.

*Std. Colors: -0 Black, -2 Red.



5169/5170 Boots



5167/5168 Jacks

Banana Plug with Screw and Soldering Lug

Model#	Thread
3265	6-32 x 0.25in (6.35mm)
3266	8-32 x 0.25in (6.35mm)

Fits standard 0.166in (4.22mm) dia. banana jack.

Material: *Banana Plug Body:* brass; *Spring:* beryllium copper; *Finish:* nickel plating.

Rating: For CE compliance and for personal safety, do not hold in hand when voltages exceed 33 Vrms/70 Vdc. Maximum voltage for *hands free use:* 5000 Vdc. Do not use on circuits where transient stresses can exceed the rated voltage. 15A.

Sold unassembled, in pkgs. of 10.

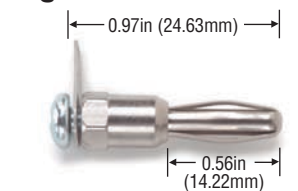

4mm Banana Plug with Threaded M3 Stud

Model# 72918

4mm plug with threaded M3 stud, 2 nuts; 12mm (0.5in) stud length.

Sold unassembled, in pkgs. of 10.

Rating: For CE compliance and for personal safety, do not hold in hand when voltages exceed 33 Vrms/70 Vdc. Maximum voltage for *hands free use:* 5000 Vdc. Do not use on circuits where transient stresses can exceed the rated voltage. 36A.

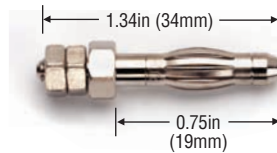

Panel Mount IEC61010 Banana Jacks for Sheathed Plugs

Model#	Color	Terminal
72912-0	Black	Threaded Stud
72912-2	Red	
72913-0	Black	Solder Tab
72913-2	Red	
72930*		Threaded Stud, Hexagonal Nut

Material: Gold-plated nickel (72912 and 72913).

Rating: 1000V Cat III, 36A Max.

*Std. Colors: -0 Black, -1 Brown, -2 Red, -4 Yellow, -5 Green, -6 Blue, -7 Violet, -8 Gray, -9 White.

Sold in packages of 10 per color.



72912



72913



72930

Panel Mount IEC61010 4 mm (0.16in) Banana Jack for Sheathed Plugs

Model# 5931-*

Accepts flexible test lead sets 5907A, 5908A, 5909A.

Max. Panel Thickness: 0.28in (7.0mm).

Insulation: Nylon.

Rating: 1000 V Cat III per IEC61010-031 and IEC61010-1, 25A.

*Std. Colors: -0 Black, -2 Red, -6 Blue, -9 White.

Sold in pkgs. of 10 per color.

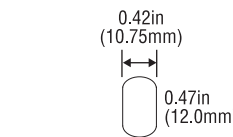
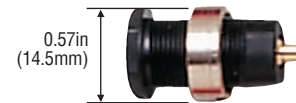

Panel Cut-Out

Banana Jack with Wire Wrap Terminal

Model# 4005-*

Material: *Jack:* nickel-plated brass; *Terminal:* gold-plated phosphor bronze; *Insulation:* polycarbonate.

Rating: For CE compliance and for personal safety, do not hold in hand when voltages exceed 33 Vrms/70 Vdc. Maximum voltage for *hands free use:* 2500 Vdc. Do not use on circuits where transient stresses can exceed the rated voltage. 3A, +239°F (+115°C) max.

*Std. Colors: -0 Black, -2 Red.

Sold in pkgs. of 10 per color.

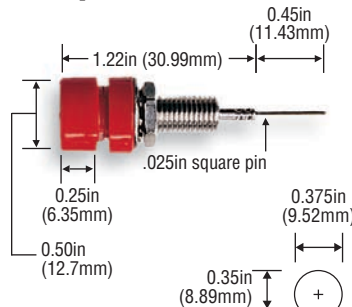

Panel Cut-Out