

2N6515, 2N6517, 2N6520

High Voltage Transistors NPN and PNP

Features

- Voltage and Current are Negative for PNP Transistors
- Pb-Free Package is Available*

MAXIMUM RATINGS

Rating	Symbol	2N6515	2N6517 2N6520	Unit
Collector – Emitter Voltage	V_{CEO}	250	350	Vdc
Collector – Base Voltage	V_{CBO}	250	350	Vdc
Emitter – Base Voltage 2N6515, 2N6516, 2N6517 2N6519, 2N6520	V_{EBO}	6.0 5.0		Vdc
Base Current	I_B	250		mAdc
Collector Current – Continuous	I_C	500		mAdc
Total Device Dissipation @ $T_A = 25^\circ\text{C}$ Derate above 25°C	P_D	625 5.0		mW mW/ $^\circ\text{C}$
Total Device Dissipation @ $T_C = 25^\circ\text{C}$ Derate above 25°C	P_D	1.5 12		Watts mW/ $^\circ\text{C}$
Operating and Storage Junction Temperature Range	T_J, T_{stg}	–55 to +150		$^\circ\text{C}$

Maximum ratings are those values beyond which device damage can occur. Maximum ratings applied to the device are individual stress limit values (not normal operating conditions) and are not valid simultaneously. If these limits are exceeded, device functional operation is not implied, damage may occur and reliability may be affected.

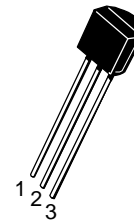
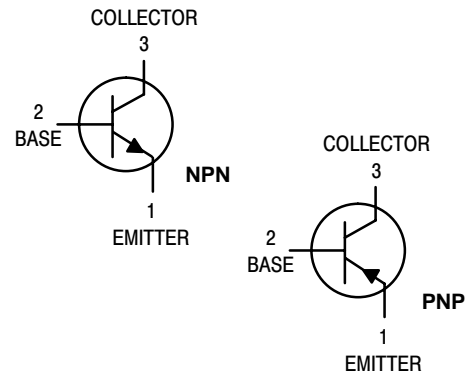
THERMAL CHARACTERISTICS

Characteristic	Symbol	Max	Unit
Thermal Resistance, Junction-to-Ambient	$R_{\theta JA}$	200	$^\circ\text{C}/\text{W}$
Thermal Resistance, Junction-to-Case	$R_{\theta JC}$	83.3	$^\circ\text{C}/\text{W}$



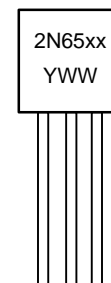
ON Semiconductor®

<http://onsemi.com>



TO-92
CASE 29
STYLE 1

MARKING DIAGRAM



Y = Year
WW = Work Week

ORDERING INFORMATION

See detailed ordering and shipping information in the package dimensions section on page 3 of this data sheet.

*For additional information on our Pb-Free strategy and soldering details, please download the ON Semiconductor Soldering and Mounting Techniques Reference Manual, SOLDERRM/D.

2N6515, 2N6517, 2N6520

ELECTRICAL CHARACTERISTICS ($T_A = 25^\circ\text{C}$ unless otherwise noted)

Characteristic	Symbol	Min	Max	Unit
OFF CHARACTERISTICS				
Collector–Emitter Breakdown Voltage (Note 1) ($I_C = 1.0\text{ mAdc}$, $I_B = 0$)	$V_{(BR)CEO}$	250 350	– –	Vdc
		2N6515 2N6517, 2N6520		
Collector–Base Breakdown Voltage ($I_C = 100\ \mu\text{Adc}$, $I_E = 0$)	$V_{(BR)CBO}$	250 350	– –	Vdc
		2N6515 2N6517, 2N6520		
Emitter–Base Breakdown Voltage ($I_E = 10\ \mu\text{Adc}$, $I_C = 0$)	$V_{(BR)EBO}$	6.0 5.0	– –	Vdc
		2N6515, 2N6517 2N6520		
Collector Cutoff Current ($V_{CB} = 150\text{ Vdc}$, $I_E = 0$) ($V_{CB} = 250\text{ Vdc}$, $I_E = 0$)	I_{CBO}	– –	50 50	nAdc
		2N6515 2N6517, 2N6520		
Emitter Cutoff Current ($V_{EB} = 5.0\text{ Vdc}$, $I_C = 0$) ($V_{EB} = 4.0\text{ Vdc}$, $I_C = 0$)	I_{EBO}	– –	50 50	nAdc
		2N6515, 2N6517 2N6520		
ON CHARACTERISTICS (Note 1)				
DC Current Gain ($I_C = 1.0\text{ mAdc}$, $V_{CE} = 10\text{ Vdc}$)	h_{FE}	35 20	– –	–
		2N6515 2N6517, 2N6520		
($I_C = 10\text{ mAdc}$, $V_{CE} = 10\text{ Vdc}$)		50 30	– –	
		2N6515 2N6517, 2N6520		
($I_C = 30\text{ mAdc}$, $V_{CE} = 10\text{ Vdc}$)		50 30	300 200	
		2N6515 2N6517, 2N6520		
($I_C = 50\text{ mAdc}$, $V_{CE} = 10\text{ Vdc}$)		45 20	220 200	
		2N6515 2N6517, 2N6520		
($I_C = 100\text{ mAdc}$, $V_{CE} = 10\text{ Vdc}$)		25 15	– –	
		2N6515 2N6517, 2N6520		
Collector–Emitter Saturation Voltage ($I_C = 10\text{ mAdc}$, $I_B = 1.0\text{ mAdc}$) ($I_C = 20\text{ mAdc}$, $I_B = 2.0\text{ mAdc}$) ($I_C = 30\text{ mAdc}$, $I_B = 3.0\text{ mAdc}$) ($I_C = 50\text{ mAdc}$, $I_B = 5.0\text{ mAdc}$)	$V_{CE(sat)}$	– – – –	0.30 0.35 0.50 1.0	Vdc
		2N6515 2N6517, 2N6520		
Base–Emitter Saturation Voltage ($I_C = 10\text{ mAdc}$, $I_B = 1.0\text{ mAdc}$) ($I_C = 20\text{ mAdc}$, $I_B = 2.0\text{ mAdc}$) ($I_C = 30\text{ mAdc}$, $I_B = 3.0\text{ mAdc}$)	$V_{BE(sat)}$	– – –	0.75 0.85 0.90	Vdc
		2N6515 2N6517, 2N6520		
Base–Emitter On Voltage ($I_C = 100\text{ mAdc}$, $V_{CE} = 10\text{ Vdc}$)	$V_{BE(on)}$	–	2.0	Vdc
		2N6515 2N6517, 2N6520		

1. Pulse Test: Pulse Width $\leq 300\ \mu\text{s}$, Duty Cycle $\leq 2.0\%$.

2N6515, 2N6517, 2N6520

SMALL-SIGNAL CHARACTERISTICS

Current-Gain – Bandwidth Product (Note 1) ($I_C = 10 \text{ mA}$, $V_{CE} = 20 \text{ Vdc}$, $f = 20 \text{ MHz}$)	f_T	40	200	MHz
Collector-Base Capacitance ($V_{CB} = 20 \text{ Vdc}$, $I_E = 0$, $f = 1.0 \text{ MHz}$)	C_{cb}	–	6.0	pF
Emitter-Base Capacitance ($V_{EB} = 0.5 \text{ Vdc}$, $I_C = 0$, $f = 1.0 \text{ MHz}$)	C_{eb}	–	80	pF
		–	100	
		2N6515, 2N6517 2N6520		

SWITCHING CHARACTERISTICS

Turn-On Time ($V_{CC} = 100 \text{ Vdc}$, $V_{BE(off)} = 2.0 \text{ Vdc}$, $I_C = 50 \text{ mA}$, $I_{B1} = 10 \text{ mA}$)	t_{on}	–	200	μs
Turn-Off Time ($V_{CC} = 100 \text{ Vdc}$, $I_C = 50 \text{ mA}$, $I_{B1} = I_{B2} = 10 \text{ mA}$)	t_{off}	–	3.5	μs

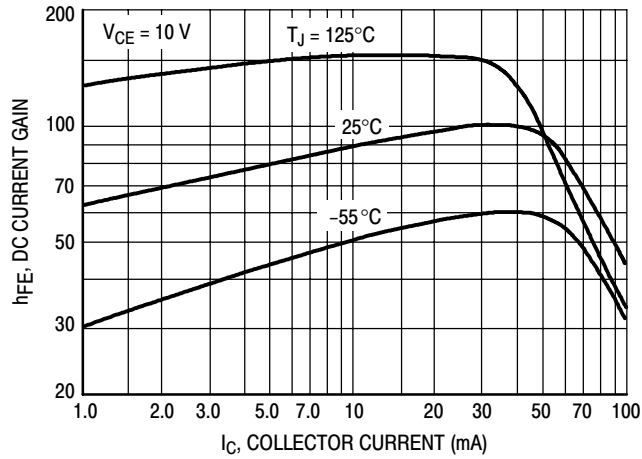
1. Pulse Test: Pulse Width $\leq 300 \mu\text{s}$, Duty Cycle $\leq 2.0\%$.

ORDERING INFORMATION

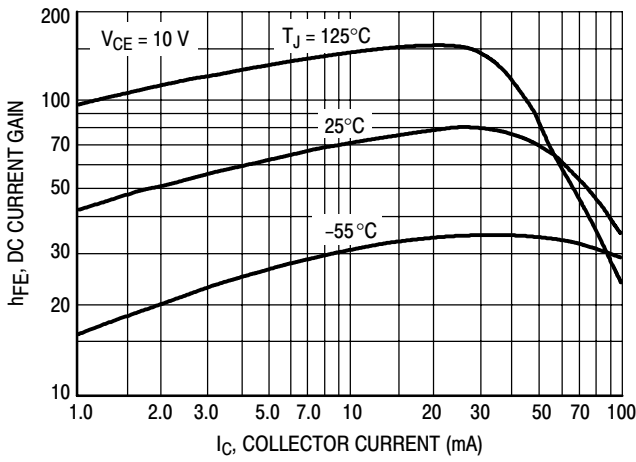
Device	Package	Shipping [†]
2N6515	TO-92	5000 Unit / Bulk
2N6515RLRM	TO-92	2000 Tape & Ammo Box
2N6517	TO-92	5000 Unit / Bulk
2N6517RLRA	TO-92	2000 Tape & Reel
2N6517RLRP	TO-92	2000 Tape & Ammo Box
2N6520RLRA	TO-92	2000 Tape & Reel
2N6520RLRAG	TO-92 (Pb-Free)	2000 Tape & Reel

[†]For information on tape and reel specifications, including part orientation and tape sizes, please refer to our Tape and Reel Packaging Specifications Brochure, BRD8011/D.

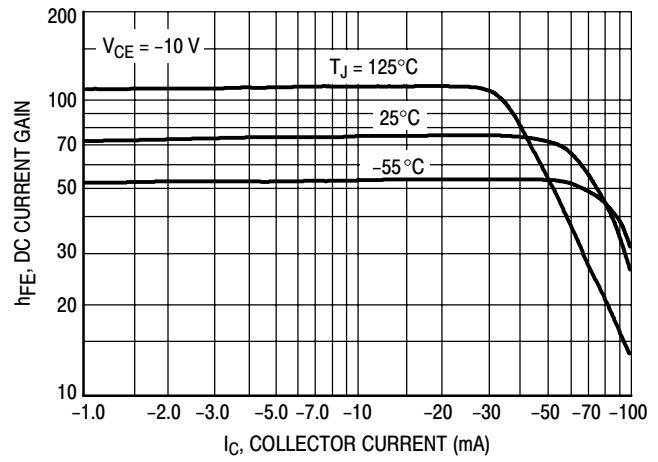
2N6515, 2N6517, 2N6520



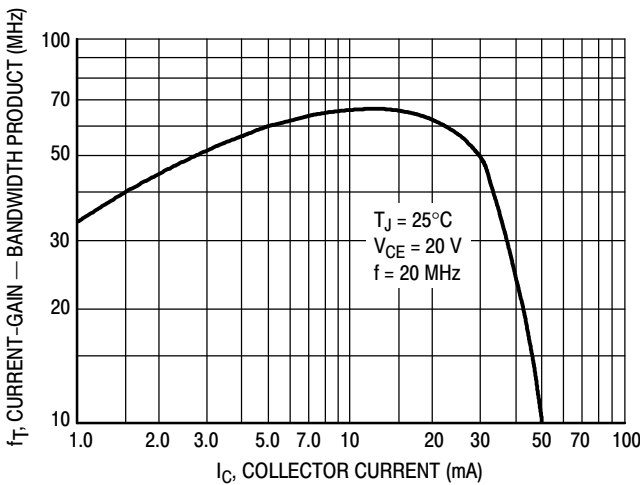
**Figure 1. DC Current Gain
NPN 2N6515**



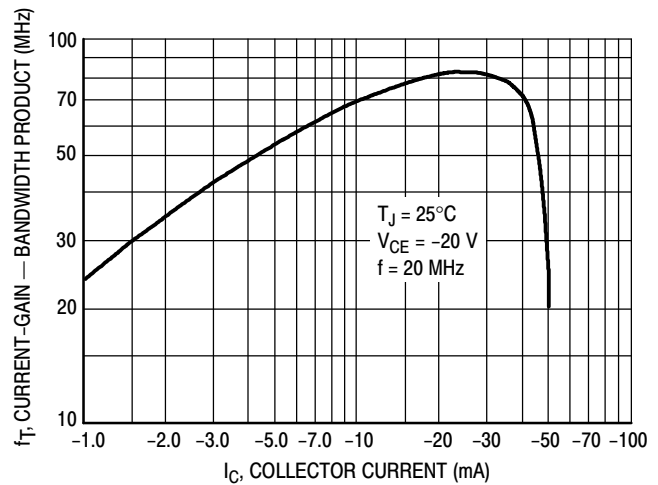
**Figure 2. DC Current Gain
NPN 2N6517**



**Figure 3. DC Current Gain
PNP 2N6520**

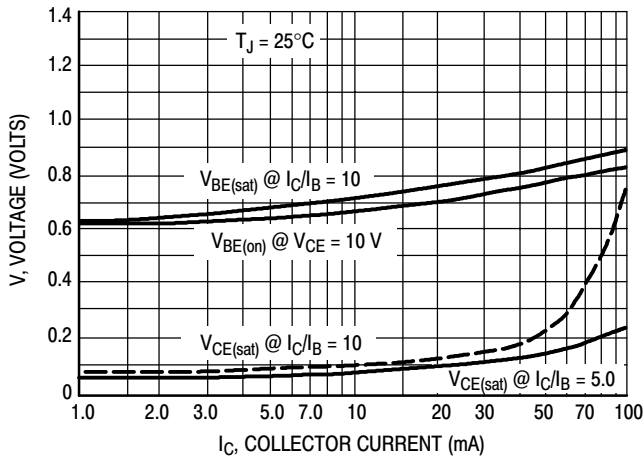


**Figure 4. Current-Gain - Bandwidth Product
NPN 2N6515, 2N6517**

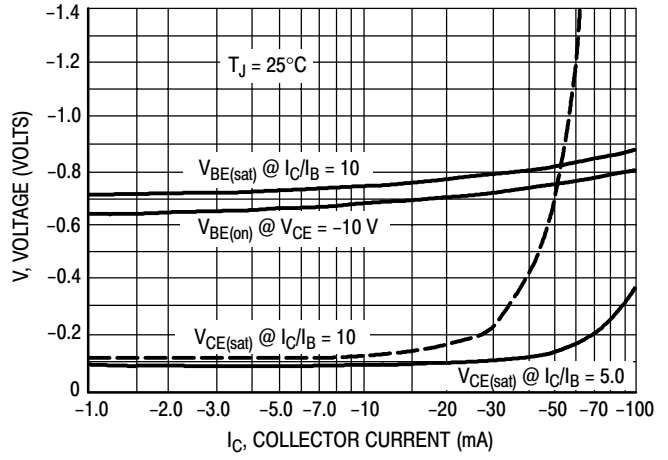


**Figure 5. Current-Gain - Bandwidth Product
PNP 2N6520**

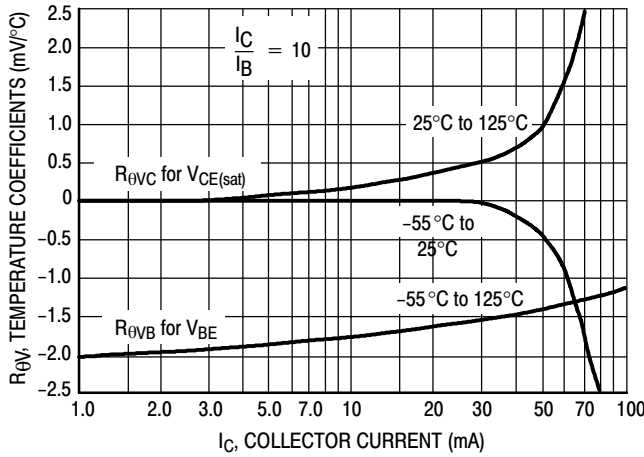
2N6515, 2N6517, 2N6520



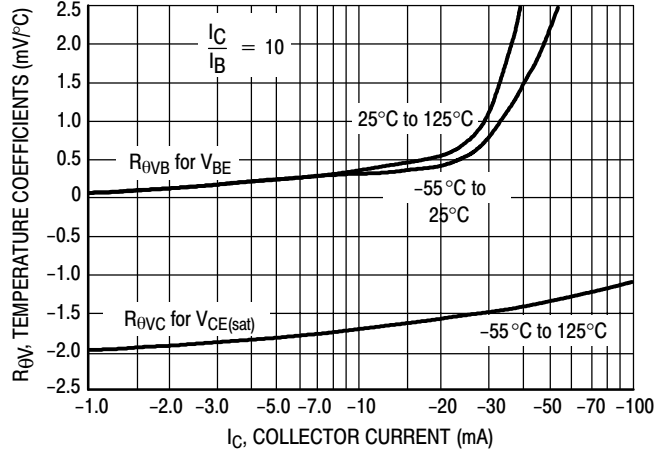
**Figure 6. "On" Voltages
NPN 2N6515, 2N6517**



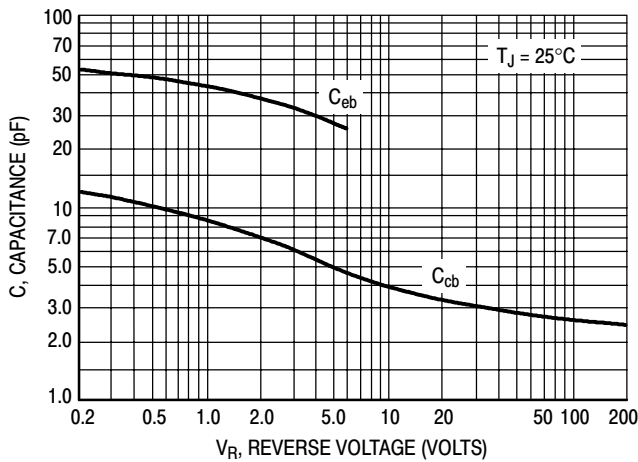
**Figure 7. "On" Voltages
PNP 2N6520**



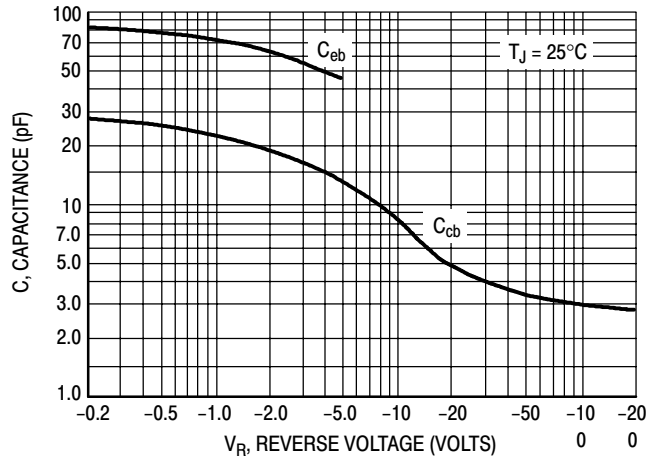
**Figure 8. Temperature Coefficients
NPN 2N6515, 2N6517**



**Figure 9. Temperature Coefficients
PNP 2N6520**

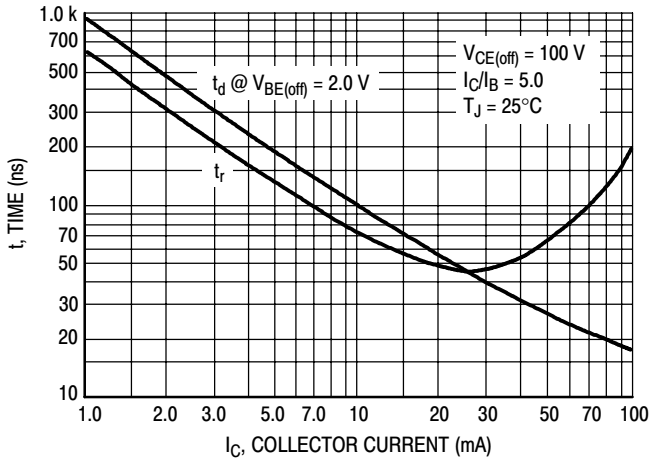


**Figure 10. Capacitance
NPN 2N6515, 2N6517**

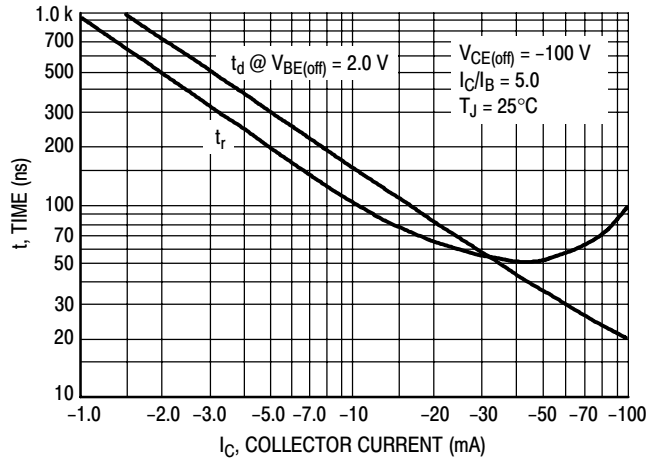


**Figure 11. Capacitance
PNP 2N6520**

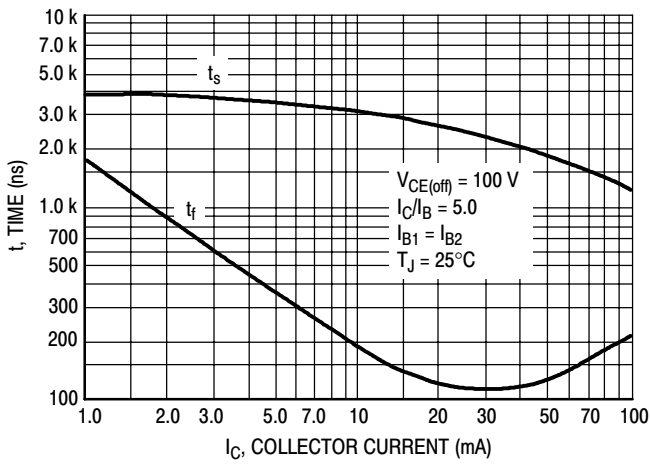
2N6515, 2N6517, 2N6520



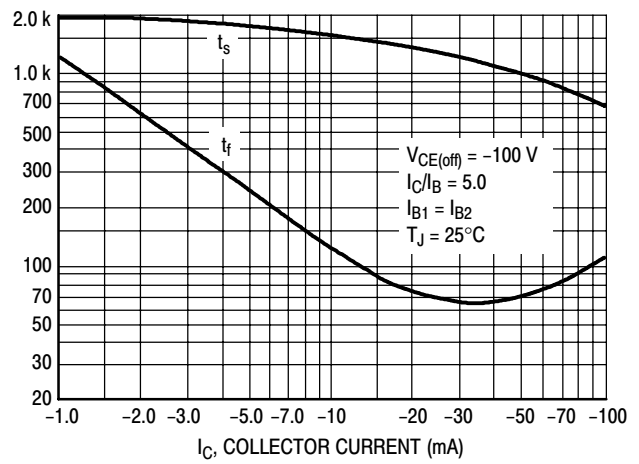
**Figure 12. Turn-On Time
NPN 2N6515, 2N6517**



**Figure 13. Turn-On Time
PNP 2N6520**



**Figure 14. Turn-Off Time
NPN 2N6515, 2N6517**



**Figure 15. Turn-Off Time
PNP 2N6520**

2N6515, 2N6517, 2N6520

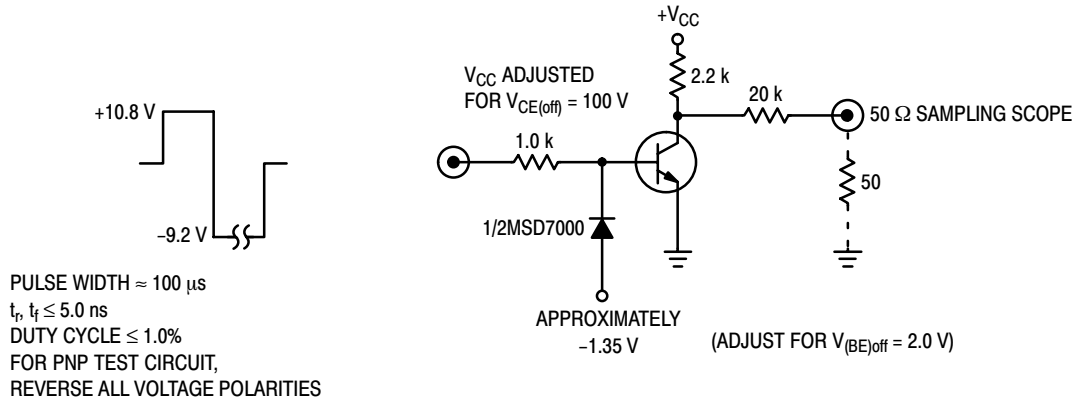


Figure 16. Switching Time Test Circuit

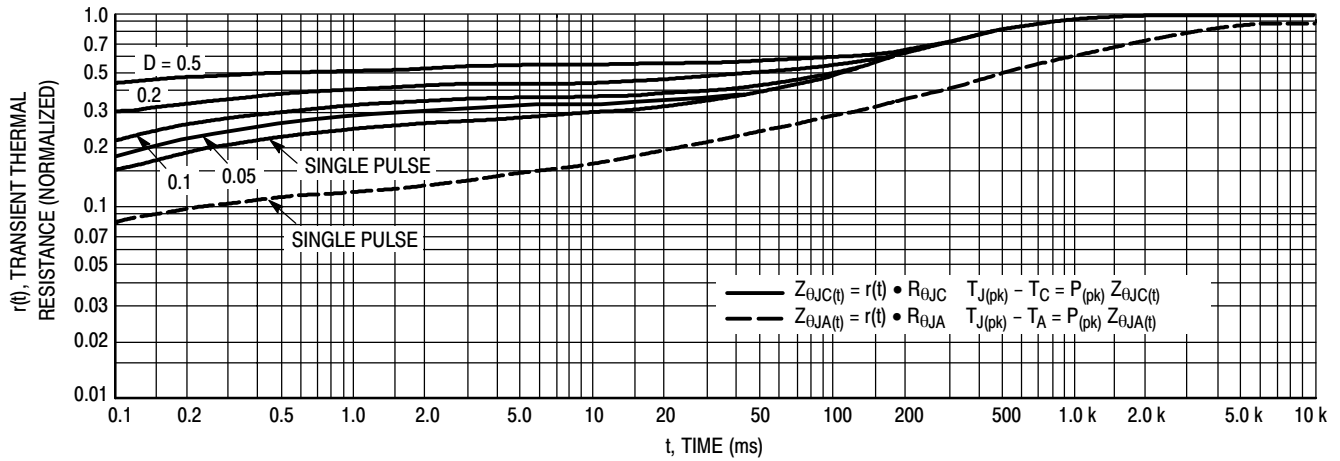


Figure 17. Thermal Response

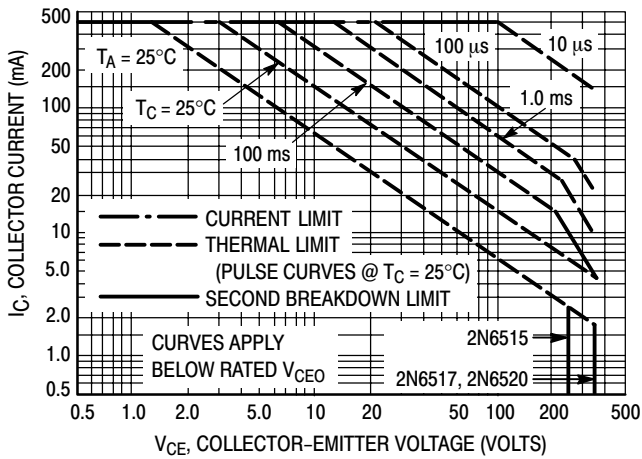
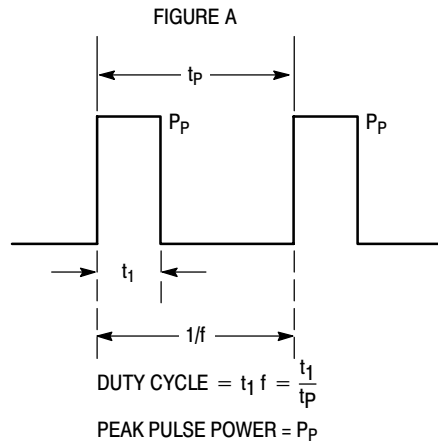


Figure 18. Active Region Safe Operating Area

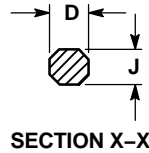
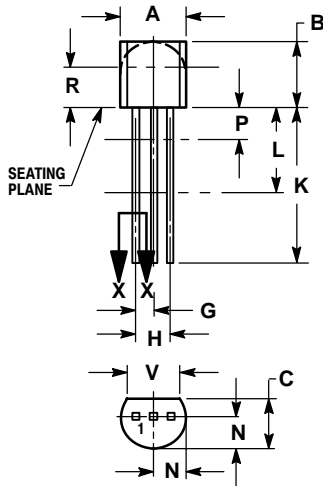


Design Note: Use of Transient Thermal Resistance Data

2N6515, 2N6517, 2N6520

PACKAGE DIMENSIONS

TO-92
CASE 29-11
ISSUE AL




NOTES:

1. DIMENSIONING AND TOLERANCING PER ANSI Y14.5M, 1982.
2. CONTROLLING DIMENSION: INCH.
3. CONTOUR OF PACKAGE BEYOND DIMENSION R IS UNCONTROLLED.
4. LEAD DIMENSION IS UNCONTROLLED IN P AND BEYOND DIMENSION K MINIMUM.

DIM	INCHES		MILLIMETERS	
	MIN	MAX	MIN	MAX
A	0.175	0.205	4.45	5.20
B	0.170	0.210	4.32	5.33
C	0.125	0.165	3.18	4.19
D	0.016	0.021	0.407	0.533
G	0.045	0.055	1.15	1.39
H	0.095	0.105	2.42	2.66
J	0.015	0.020	0.39	0.50
K	0.500	---	12.70	---
L	0.250	---	6.35	---
N	0.080	0.105	2.04	2.66
P	---	0.100	---	2.54
R	0.115	---	2.93	---
V	0.135	---	3.43	---

STYLE 1:

1. EMITTER
2. BASE
3. COLLECTOR

ON Semiconductor and  are registered trademarks of Semiconductor Components Industries, LLC (SCILLC). SCILLC reserves the right to make changes without further notice to any products herein. SCILLC makes no warranty, representation or guarantee regarding the suitability of its products for any particular purpose, nor does SCILLC assume any liability arising out of the application or use of any product or circuit, and specifically disclaims any and all liability, including without limitation special, consequential or incidental damages. "Typical" parameters which may be provided in SCILLC data sheets and/or specifications can and do vary in different applications and actual performance may vary over time. All operating parameters, including "Typicals" must be validated for each customer application by customer's technical experts. SCILLC does not convey any license under its patent rights nor the rights of others. SCILLC products are not designed, intended, or authorized for use as components in systems intended for surgical implant into the body, or other applications intended to support or sustain life, or for any other application in which the failure of the SCILLC product could create a situation where personal injury or death may occur. Should Buyer purchase or use SCILLC products for any such unintended or unauthorized application, Buyer shall indemnify and hold SCILLC and its officers, employees, subsidiaries, affiliates, and distributors harmless against all claims, costs, damages, and expenses, and reasonable attorney fees arising out of, directly or indirectly, any claim of personal injury or death associated with such unintended or unauthorized use, even if such claim alleges that SCILLC was negligent regarding the design or manufacture of the part. SCILLC is an Equal Opportunity/Affirmative Action Employer. This literature is subject to all applicable copyright laws and is not for resale in any manner.

PUBLICATION ORDERING INFORMATION

LITERATURE FULFILLMENT:
Literature Distribution Center for ON Semiconductor
P.O. Box 5163, Denver, Colorado 80217 USA
Phone: 303-675-2175 or 800-344-3860 Toll Free USA/Canada
Fax: 303-675-2176 or 800-344-3867 Toll Free USA/Canada
Email: orderlit@onsemi.com

N. American Technical Support: 800-282-9855 Toll Free
USA/Canada

Japan: ON Semiconductor, Japan Customer Focus Center
2-9-1 Kamimeguro, Meguro-ku, Tokyo, Japan 153-0051
Phone: 81-3-5773-3850

ON Semiconductor Website: <http://onsemi.com>

Order Literature: <http://www.onsemi.com/litorder>

For additional information, please contact your local Sales Representative.