

MAX9030/MAX9031/ MAX9032/MAX9034

Low-Cost, Ultra-Small, Single/Dual/Quad Single-Supply Comparators

General Description

The MAX9030/MAX9031/MAX9032/MAX9034 single/dual/quad comparators are optimized for single-supply applications from +2.5V to +5.5V but can also be operated from dual supplies. These comparators have a 188ns propagation delay and consume 35µA of supply current per comparator over the -40°C to +125°C operating temperature range. The combination of low-power, single-supply operation down to +2.5V, and ultra-small footprint makes these devices ideal for portable applications.

The MAX9030 is a low-cost single comparator with shutdown. The MAX9031, MAX9032, and MAX9034 are low-cost single, dual, and quad comparators without shutdown, respectively. The comparators' 4mV of built-in hysteresis provides noise immunity and prevents oscillations even with a slow-moving input signal. The input common-mode range extends from the negative supply to within 1.1V of the positive supply. The design of the comparator output stage substantially reduces switching current during output transitions, virtually eliminating power-supply glitches.

The MAX9030 single comparator with shutdown is available in the space-saving 6-pin SC70 and SOT23 packages. The MAX9031 single comparator is available in tiny 5-pin SC70 and SOT23 packages. The MAX9032 dual comparator is available in 8-pin SOT23 and µMAX® packages, and the MAX9034 quad comparator is available in a 14-pin TSSOP package.

Applications

Battery-Powered Portable Systems	Digital Line Receivers
Mobile Communications	Keyless Entry Systems
Sensor Signal Detection	Threshold Detectors/ Discriminators
Photodiode Preamps	

µMAX is a registered trademark of Maxim Integrated Products, Inc.

Features

- ◆ Low-Cost Solution Available in Space-Saving SC70 Packages (MAX9030/MAX9031)
- ◆ +2.5 to +5.5V Single-Supply Voltage Range
- ◆ Comparator Output Swings Rail-to-Rail
- ◆ Internal 4mV Comparator Hysteresis
- ◆ 188ns Propagation Delay
- ◆ Low 35µA Supply Current
- ◆ No Phase Reversal for Overdriven Inputs
- ◆ Space-Saving Packages
 - 5-Pin SC70 (MAX9031)
 - 6-Pin SC70 (MAX9030)
 - 8-Pin SOT23 (MAX9032)
 - 14-Pin TSSOP (MAX9034)

Ordering Information

PART	TEMP. RANGE	PIN-PACKAGE
MAX9030AXT+T	-40°C to +125°C	6 SC70
MAX9030AUT+T	-40°C to +125°C	6 SOT23
MAX9031AXK+T	-40°C to +125°C	5 SC70
MAX9031AUK+T	-40°C to +125°C	5 SOT23
MAX9032AKA+T	-40°C to +125°C	8 SOT23
MAX9032AUA+	-40°C to +125°C	8 µMAX
MAX9032ASA+	-40°C to +125°C	8 SO
MAX9032ASA/V+	-40°C to +125°C	8 SO
MAX9034AUD+	-40°C to +125°C	14 TSSOP
MAX9034ASD+	-40°C to +125°C	14 SO

+Denotes a lead-free(Pb)/RoHS-compliant package.

T = Tape and reel.

/V denotes an automotive qualified package.

Typical Application Circuit appears at end of data sheet.

Pin Configurations

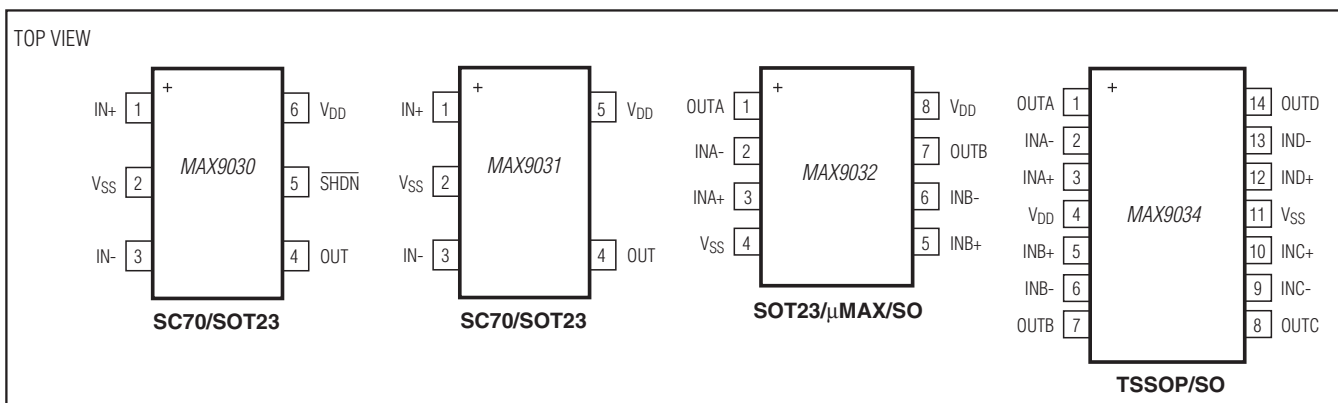

For pricing, delivery, and ordering information, please contact Maxim Direct at 1-888-629-4642, or visit Maxim's website at www.maximintegrated.com.

MAX9030/MAX9031/MAX9032/MAX9034

Low-Cost, Ultra-Small, Single/Dual/Quad Single-Supply Comparators

ABSOLUTE MAXIMUM RATINGS

Supply Voltage (V_{DD} to V_{SS})	-0.3V to +6V	8-Pin SOT23 (derate 9.1mW/°C above +70°C)	727mW
Voltage Inputs ($IN+$, $IN-$ to V_{SS})	-0.3V to (V_{DD} + 0.3V)	8-Pin μ MAX (derate 4.5mW/°C above +70°C)	362mW
Differential Input Voltage ($IN+$ to $IN-$)	+6.6V	8-Pin SO (derate 5.88mW/°C above +70°C)	471mW
Output Short-Circuit		14-Pin TSSOP (derate 9.1mW/°C above +70°C)	727mW
Duration	2s to Either V_{DD} or V_{SS}	14-Pin SO (derate 8.33mW/°C above +70°C)	667mW
Current into Any Pin	20mA	Operating Temperature Range	
Continuous Power Dissipation ($T_A = +70^\circ\text{C}$)		Automotive Application	-40°C to +125°C
5-Pin SC70 (derate 3.1mW/°C above +70°C)	247mW	Junction Temperature	+150°C
5-Pin SOT23 (derate 7.1mW/°C above +70°C)	571mW	Storage Temperature Range	-65°C to +150°C
6-Pin SC70 (derate 3.1mW/°C above +70°C)	245mW	Lead Temperature (soldering, 10s)	+300°C
6-Pin SOT23 (derate 8.7mW/°C above +70°C)	696mW	Soldering Temperature (reflow)	+260°C

Stresses beyond those listed under "Absolute Maximum Ratings" may cause permanent damage to the device. These are stress ratings only, and functional operation of the device at these or any other conditions beyond those indicated in the operational sections of the specifications is not implied. Exposure to absolute maximum rating conditions for extended periods may affect device reliability.

ELECTRICAL CHARACTERISTICS

($V_{DD} = +5\text{V}$, $V_{SS} = 0$, $V_{CM} = 0$, $V_{\overline{\text{SHDN}}} = +5\text{V}$ (Note 1), $T_A = -40^\circ\text{C}$ to $+125^\circ\text{C}$, unless otherwise noted. Typical values are at $T_A = +25^\circ\text{C}$.) (Note 2)

PARAMETER	SYMBOL	CONDITIONS	MIN	TYP	MAX	UNITS
Operating Voltage Range	V_{DD}	Guaranteed by PSRR test	2.5		5.5	V
Supply Current per Comparator	I_{DD}			35	55	μA
Supply Current in Shutdown		$V_{\overline{\text{SHDN}}} = 0$ (Note 1)		0.05	1	μA
Shutdown Input Bias Current		$V_{\overline{\text{SHDN}}} = 0$ to V_{DD} (Note 1)		0.1	2.5	μA
Shutdown Logic High		(Note 1)	$0.7 \times V_{DD}$			V
Shutdown Logic Low		(Note 1)			$0.3 \times V_{DD}$	V
Input Offset Voltage	V_{OS}	(Note 3)		± 1	± 5	mV
Input Offset Voltage Temperature Coefficient	TCV_{OS}			± 1		$\mu\text{V}/^\circ\text{C}$
Hysteresis		(Note 4)		4		mV
Input Bias Current	I_{BIAS}			8	80	nA
Input Offset Current	I_{OS}			± 2	± 60	nA
Common-Mode Voltage Range	V_{CM}	Guaranteed by CMRR test	V_{SS}		$V_{DD} - 1.1$	V
Common-Mode Rejection Ratio	CMRR	$V_{SS} \leq V_{CM} \leq (V_{DD} - 1.1\text{V})$, $V_{DD} = +5.5\text{V}$	72	100		dB
Power-Supply Rejection Ratio	PSRR	$V_{DD} = +2.5\text{V}$ to $+5.5\text{V}$	72	100		dB

MAX9030/MAX9031/MAX9032/MAX9034

Low-Cost, Ultra-Small, Single/Dual/Quad Single-Supply Comparators

ELECTRICAL CHARACTERISTICS (continued)

($V_{DD} = +5V$, $V_{SS} = 0$, $V_{CM} = 0$, $V_{SHDN} = +5V$ (Note 1), $T_A = -40^{\circ}C$ to $+125^{\circ}C$, unless otherwise noted. Typical values are at $T_A = +25^{\circ}C$.) (Note 2)

PARAMETER	SYMBOL	CONDITIONS	MIN	TYP	MAX	UNITS
Output Voltage-Swing	V_{OL} , V_{OH}	$V_{OH} = V_{DD} - V_{OUT}$, ($V_{IN+} - V_{IN-}$) $\geq 20mV$	$I_{SOURCE} = 10\mu A$		2	mV
			$I_{SOURCE} = 4mA$	165	400	
		$V_{OL} = V_{OUT} - V_{SS}$, ($V_{IN-} - V_{IN+}$) $\geq 20mV$	$I_{SINK} = 10\mu A$		2	
			$I_{SINK} = 4mA$	165	400	
Output Short-Circuit Current	I_{SC}			45		mA
Shutdown Mode Output Leakage		$V_{SHDN} \leq (0.3 \times V_{DD})$, $V_{OUT} = 0$ to V_{DD} (Note 1)		± 0.01	± 3.5	μA
Propagation Delay	t_{PD+} , t_{PD-}	$R_L = 10k\Omega$, $C_L = 15pF$ (Note 5)	$V_{OD} = 10mV$		228	ns
			$V_{OD} = 100mV$		188	
Rise/Fall-Time	t_R , t_F	$V_{DD} = +5V$, $R_L = 10k\Omega$, $C_L = 15pF$ (Note 6)		20		ns
Shutdown Delay Time ON/OFF		(Note 1)		40		ns
Shutdown Delay Time OFF/ON		(Note 1)		400		ns
Power-On Time		$R_L = 10k\Omega$, $C_L = 15pF$		200		ns
Maximum Capacitive Load	C_L	No sustained oscillations		150		pF

Note 1: MAX9030 only.

Note 2: All devices are production tested at $+25^{\circ}C$. All temperature limits are guaranteed by design.

Note 3: Comparator Input Offset is defined as the center of the hysteresis zone.

Note 4: Hysteresis is defined as the difference of the trip points required to change comparator output states.

Note 5: V_{OD} is the overdrive that is beyond the offset and hysteresis-determined trip points.

Note 6: Rise and fall times are measured between 10% and 90% at OUT.

Typical Operating Characteristics

($V_{DD} = +5V$, $V_{SS} = 0$, $V_{CM} = 0$, $R_L = 10k\Omega$, $C_L = 15pF$, $V_{OD} = 100mV$, $T_A = +25^{\circ}C$, unless otherwise noted.)

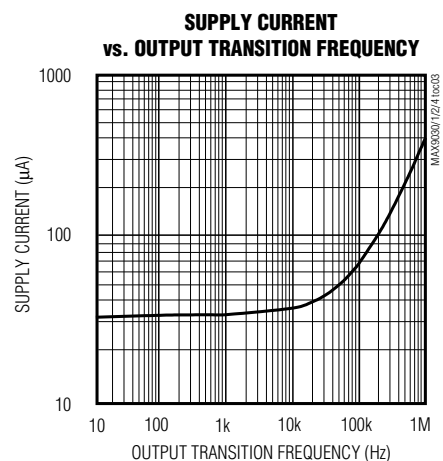
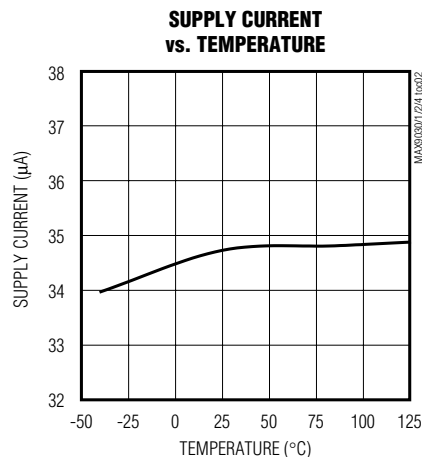
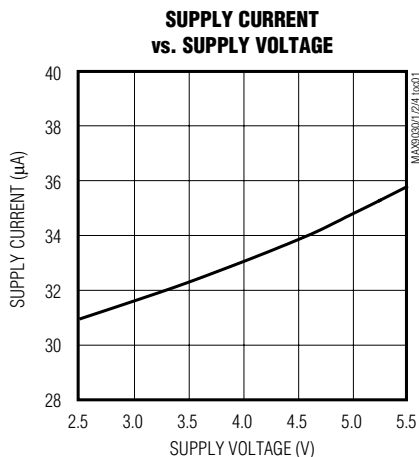

MAX9030/MAX9031/MAX9032/MAX9034

Low-Cost, Ultra-Small, Single/Dual/Quad Single-Supply Comparators

Typical Operating Characteristics (continued)

($V_{DD} = +5V$, $V_{SS} = 0$, $V_{CM} = 0$, $R_L = 10k\Omega$, $C_L = 15pF$, $V_{OD} = 100mV$, $T_A = +25^\circ C$, unless otherwise noted.)

INPUT OFFSET VOLTAGE vs. TEMPERATURE

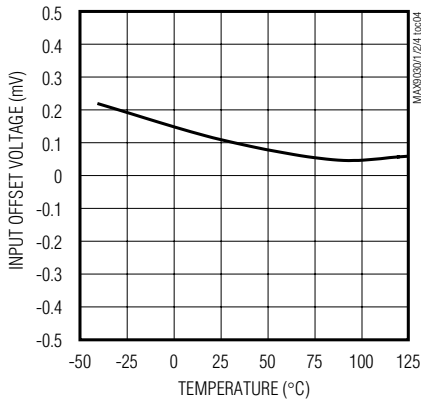

OUTPUT HIGH VOLTAGE vs. SOURCE CURRENT

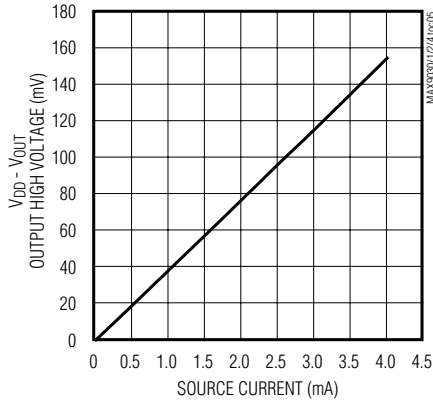

OUTPUT LOW VOLTAGE vs. SINK CURRENT

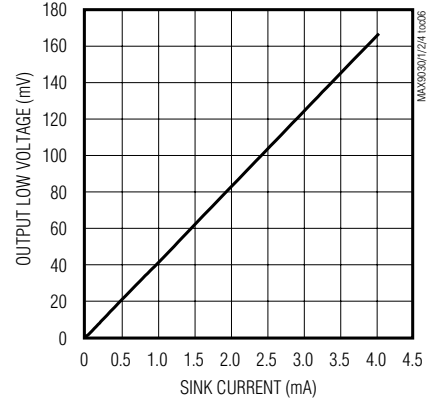

OUTPUT SHORT-CIRCUIT (SINK) CURRENT vs. TEMPERATURE

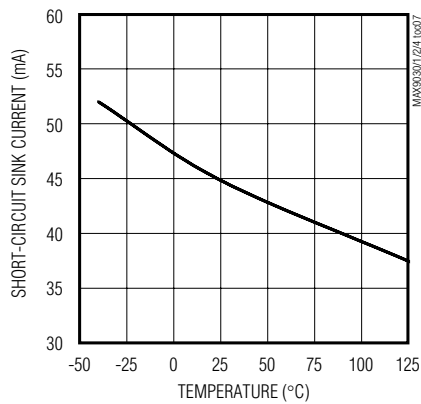

OUTPUT SHORT-CIRCUIT (SOURCE) CURRENT vs. TEMPERATURE

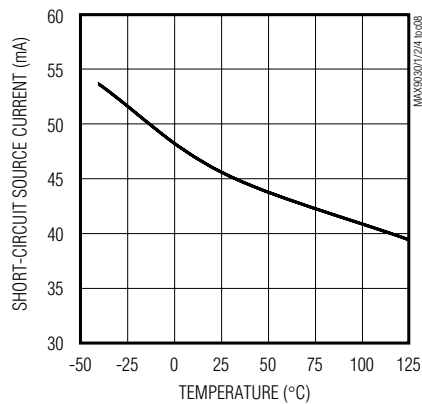

PROPAGATION DELAY vs. CAPACITIVE LOAD ($V_{DD} = 2.7V$)

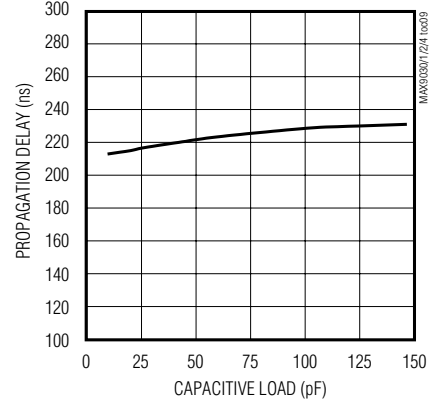

PROPAGATION DELAY vs. CAPACITIVE LOAD ($V_{DD} = +5V$)

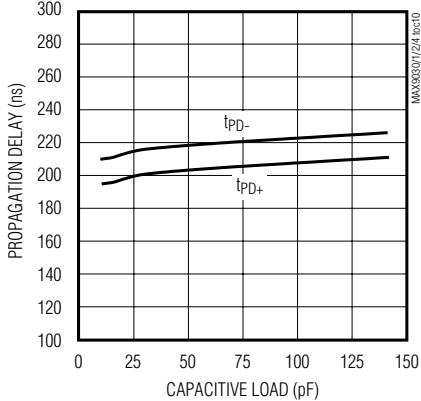

PROPAGATION DELAY vs. TEMPERATURE

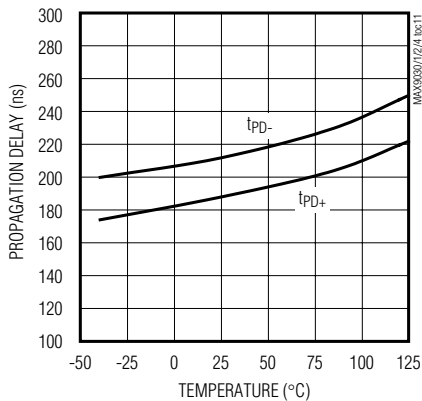

PROPAGATION DELAY vs. INPUT OVERDRIVE VOLTAGE

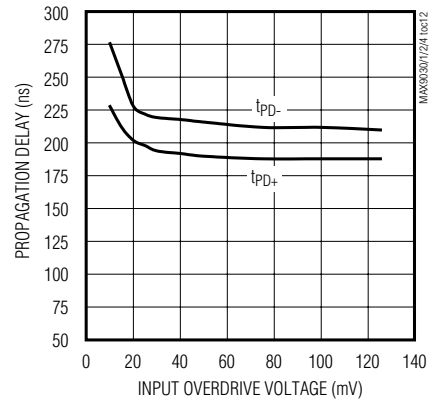

MAX9030/MAX9031/MAX9032/MAX9034

Low-Cost, Ultra-Small, Single/Dual/Quad Single-Supply Comparators

Typical Operating Characteristics (continued)

($V_{DD} = +5V$, $V_{SS} = 0$, $V_{CM} = 0$, $R_L = 10k\Omega$, $C_L = 15pF$, $V_{OD} = 100mV$, $T_A = +25^\circ C$, unless otherwise noted.)

PROPAGATION DELAY

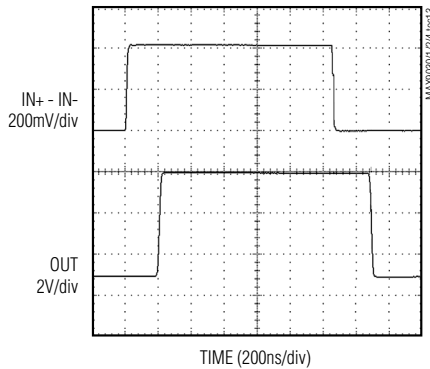

OUTPUT SWITCHING CURRENT, RISING

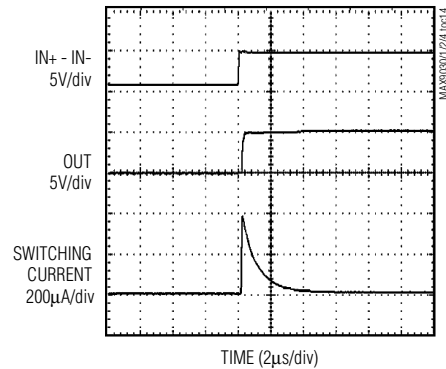

OUTPUT SWITCHING CURRENT, FALLING

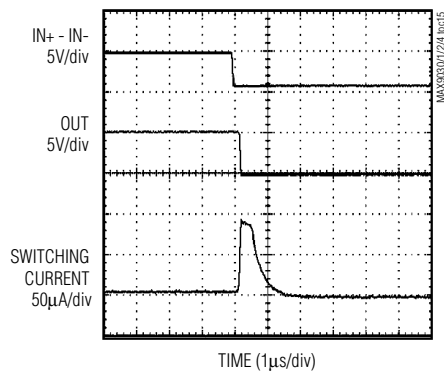

SINUSOID 1MHz RESPONSE AT 1.25MHz
 $V_{OD} = 100mV$

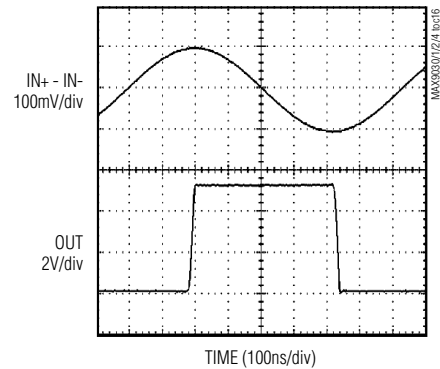

SINUSOID 1MHz RESPONSE AT 1.25MHz
 $V_{OD} = 10mV$

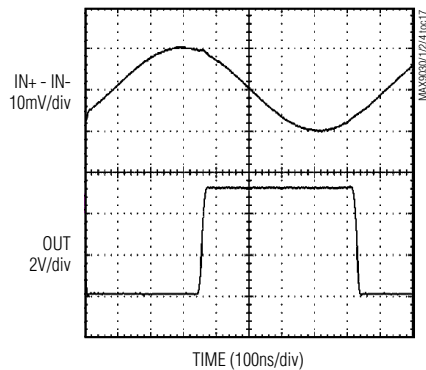

POWER-UP DELAY

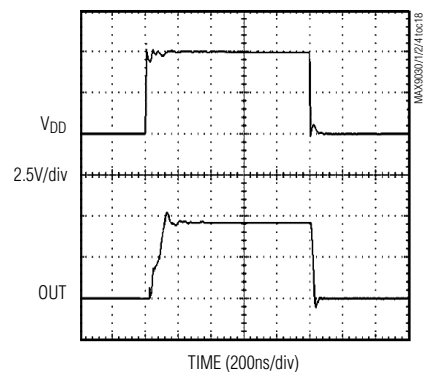

MAX9030/MAX9031/MAX9032/MAX9034

Low-Cost, Ultra-Small, Single/Dual/Quad Single-Supply Comparators

Pin Description

PIN				NAME	FUNCTION
MAX9030	MAX9031	MAX9032	MAX9034		
1	1	—	—	IN+	Comparator Noninverting Input
2	2	4	11	V _{SS}	Negative Supply Voltage. Bypass with a 0.1μF capacitor.
3	3	—	—	IN-	Comparator Inverting Input
4	4	—	—	OUT	Comparator Output
5	—	—	—	$\overline{\text{SHDN}}$	Shutdown
6	5	8	4	V _{DD}	Positive Supply Voltage. Bypass with a 0.1μF capacitor.
—	—	1	1	OUTA	Comparator A Output
—	—	2	2	INA-	Comparator A Inverting Input
—	—	3	3	INA+	Comparator A Noninverting Input
—	—	5	5	INB+	Comparator B Noninverting Input
—	—	6	6	INB-	Comparator B Inverting Input
—	—	7	7	OUTB	Comparator B Output
—	—	—	8	OUTC	Comparator C Output
—	—	—	9	INC-	Comparator C Inverting Input
—	—	—	10	INC+	Comparator C Noninverting Input
—	—	—	12	IND+	Comparator D Noninverting Input
—	—	—	13	IND-	Comparator D Inverting Input
—	—	—	14	OUTD	Comparator D Output

Detailed Description

The MAX9030/MAX9031/MAX9032/MAX9034 are single/dual/quad low-cost comparators. They have an operating supply voltage from +2.5V to +5.5V when operating from a single supply and from ±1.25V to ±2.75V when operating from dual power supplies, and consume only 35μA. Their common-mode input voltage range extends from the negative supply to within 1.1V of the positive supply. Internal hysteresis ensures clean output switching, even with slow-moving input signals.

Shutdown Mode

The MAX9030 comparator comes with a power-saving shutdown mode. When in shutdown, the supply current drops from a typical 35μA to 0.05μA, and the outputs become high impedance. $\overline{\text{SHDN}}$ has a high input impedance and typically draws 0.1μA when connected to V_{SS} or V_{DD}. A maximum logic low voltage of $0.3V \times V_{DD}$

applied to $\overline{\text{SHDN}}$ places the device in the shutdown mode. A minimum logic high voltage of $0.7V \times V_{DD}$ applied to $\overline{\text{SHDN}}$ will enable normal operation. To disable shutdown, connect $\overline{\text{SHDN}}$ to V_{DD}.

Applications Information

Adding Hysteresis

Hysteresis extends the comparator's noise margin by increasing the upper threshold and decreasing the lower threshold. A voltage-divider from the output of the comparator sets the trip voltage. Therefore, the trip voltage is related to the output voltage.

These comparators have 4mV internal hysteresis. Additional hysteresis can be generated with two resistors using positive feedback (Figure 1). Use the following procedure to calculate resistor values:

MAX9030/MAX9031/MAX9032/MAX9034

Low-Cost, Ultra-Small, Single/Dual/Quad Single-Supply Comparators

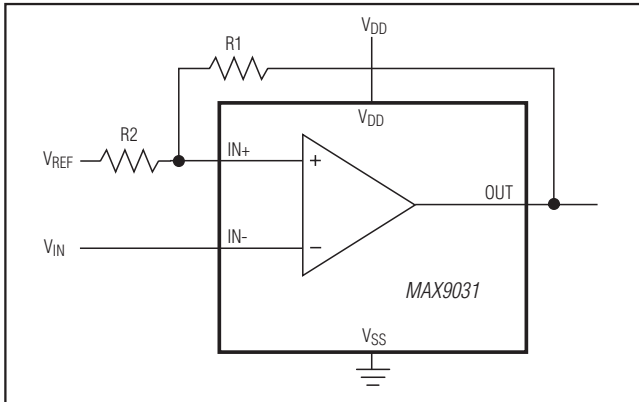

Figure 1. Additional Hysteresis

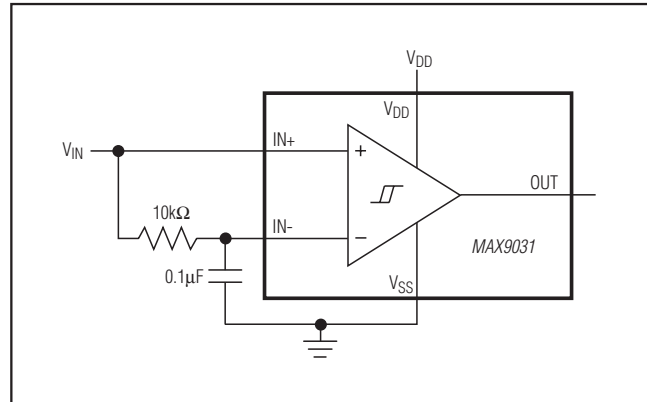

Figure 2. Time Averaging of the Input Signal for Data Recovery

- 1) Find the trip points of the comparator using these formulas:

$$V_{TH} = V_{REF} + \left[\frac{(V_{DD} - V_{REF})R_2}{R_1 + R_2} \right]$$

$$V_{TL} = V_{REF} \left(1 - \frac{R_2}{R_1 + R_2} \right)$$

where V_{TH} is the threshold voltage at which the comparator switches its output from high to low as V_{IN} rises above the trip point. V_{TL} is the threshold voltage at which the comparator switches its output from low to high as V_{IN} drops below the trip point.

- 2) The hysteresis band will be:

$$V_{HYS} = V_{TH} - V_{TL} = V_{DD} \left(\frac{R_2}{R_1 + R_2} \right)$$

- 3) In this example, let $V_{DD} = +5V$ and $V_{REF} = +2.5V$.

$$V_{TH} = 2.5V + 2.5 \left(\frac{R_2}{R_1 + R_2} \right) V$$

and

$$V_{TL} = 2.5 \left[1 - \left(\frac{R_2}{R_1 + R_2} \right) \right]$$

- 4) Select R_2 . In this example, we will choose $1k\Omega$.
- 5) Select V_{HYS} . In this example, we will choose $50mV$.
- 6) Solve for R_1 .

$$V_{HYS} = V_{DD} \left(\frac{R_2}{R_1 + R_2} \right)$$

$$0.050V = 5 \left(\frac{1000\Omega}{R_1 + 1000\Omega} \right) V$$

where $R_1 \approx 100k\Omega$, $V_{TH} = 2.525V$, and $V_{TL} = 2.475V$.

The above-described design procedure assumes rail-to-rail output swing. If the output is significantly loaded, the results should be corrected.

Board Layout and Bypassing

Use $100nF$ bypass as a starting point. Minimize signal trace lengths to reduce stray capacitance. Minimize the capacitive coupling between $IN-$ and OUT . For slow-moving input signals (rise-time $> 1ms$), use a $1nF$ capacitor between $IN+$ and $IN-$.

Biasing for Data Recovery

Digital data is often embedded into a bandwidth and amplitude-limited analog path. Recovering the data can be difficult. Figure 2 compares the input signal to a time-averaged version of itself. This self-biases the threshold to the average input voltage for optimal noise margin. Even severe phase distortion is eliminated from the digital output signal. Be sure to choose R_1 and C_1 so that:

$$f_{CAR} \gg 1 / (2\pi R_1 C_1)$$

where f_{CAR} is the fundamental carrier frequency of the digital data stream.

MAX9030/MAX9031/MAX9032/MAX9034

Low-Cost, Ultra-Small, Single/Dual/Quad Single-Supply Comparators

Typical Application Circuit

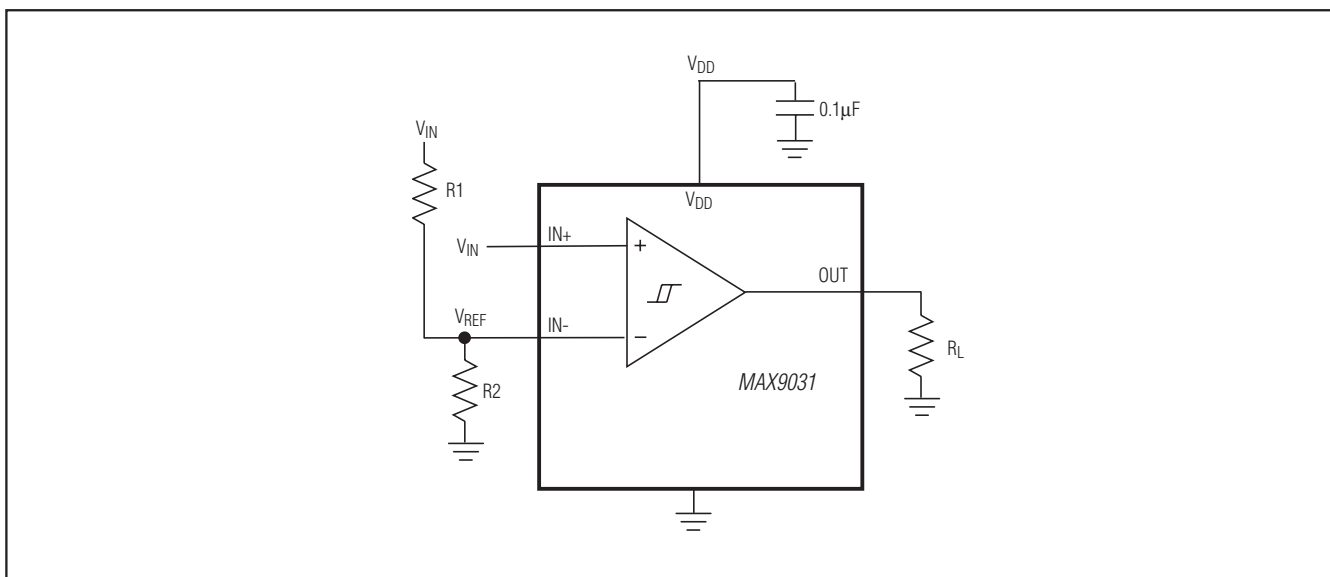

Package Information

For the latest package outline information and land patterns (footprints), go to www.maximintegrated.com/packages. Note that a "+", "#", or "-" in the package code indicates RoHS status only. Package drawings may show a different suffix character, but the drawing pertains to the package regardless of RoHS status.

PACKAGE TYPE	PACKAGE CODE	OUTLINE NO.	LAND PATTERN NO.
5 SC70	X5+1	21-0076	90-0188
6 SC70	X6SN+1	21-0077	90-0189
5 SOT23	U5+1	21-0057	90-0174
6 SOT23	U6SN+1	21-0058	90-0175
8 SOT23	K8+5	21-0078	90-0176
8 SO	S8+2	21-0262	90-0096
14 SO	S14+1	21-0041	90-0112
8 µMAX	U8+1	21-0036	90-0092
14 TSSOP	U14+1	21-0066	90-0113

MAX9030/MAX9031/MAX9032/MAX9034

Low-Cost, Ultra-Small, Single/Dual/Quad Single-Supply Comparators

Revision History

REVISION NUMBER	REVISION DATE	DESCRIPTION	PAGES CHANGED
0	10/00	Initial release	—
1	5/10	Removed future product reference and added lead-free parts	1
2	8/12	Added MAX9032ASA/V+ to data sheet	1



Maxim Integrated cannot assume responsibility for use of any circuitry other than circuitry entirely embodied in a Maxim Integrated product. No circuit patent licenses are implied. Maxim Integrated reserves the right to change the circuitry and specifications without notice at any time. The parametric values (min and max limits) shown in the Electrical Characteristics table are guaranteed. Other parametric values quoted in this data sheet are provided for guidance.

Maxim Integrated 160 Rio Robles, San Jose, CA 95134 USA 1-408-601-1000

9