



# HMC941LP4 / 941LP4E

## 0.5 dB LSB GaAs MMIC 5-BIT DIGITAL ATTENUATOR, 0.1 - 33 GHz

### Typical Applications

The HMC941LP4 / HMC941LP4E is ideal for:

- Fiber Optics & Broadband Telecom
- Microwave Radio & VSAT
- Military Radios, Radar & ECM
- Space Applications
- Sensors
- Test & Measurement Equipment

### Features

- 0.5 dB LSB Steps to 15.5 dB
- Single Positive Control Line Per Bit
- ±0.5 dB Typical Bit Error
- High Input IP3: +45 dBm
- 16mm<sup>2</sup> Leadless SMT Plastic Package

### Functional Diagram

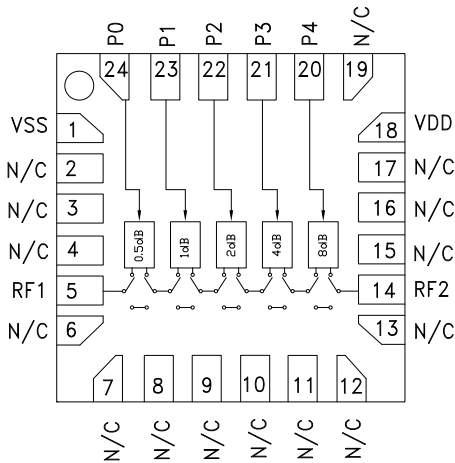

### General Description

The HMC941LP4 & HMC941LP4E are broadband 5-bit GaAs IC digital attenuators in low cost leadless surface mount packages. Covering 0.1 to 33.0 GHz, the insertion loss is less than 4 dB typical. The attenuator bit values are 0.5 (LSB), 1, 2, 4, 8, for a total attenuation of 15.5 dB. Attenuation accuracy is excellent at ±0.3 dB typical step error with an IIP3 of +45 dBm. Five control voltage inputs, toggled between +5V and 0V, are used to select each attenuation state.

### Electrical Specifications, $T_A = +25^\circ C$ , With $V_{dd} = +5V$ , $V_{ss} = -5V$ , $P_0 - P_4 = 0 / +5V$

Parameter	Frequency (GHz)	Min.	Typ.	Max.	Units
Insertion Loss	0.1 - 18.0 GHz		3.0	4.5	dB
	18.0 - 26.5 GHz		4.0	6.0	dB
	26.5 - 33.0 GHz		5.0	6.5	dB
Attenuation Range	0.1 - 33.0 GHz		15.5		dB
Return Loss (RF1 & RF2, All Atten. States)	0.1 - 33.0 GHz		12		dB
Attenuation Accuracy: (Referenced to Insertion Loss)	0.5 - 7.5 dB States	0.1 - 33.0 GHz	± (0.3 + 4%) of Atten. Setting Max		dB
	8 - 15.5 dB States	0.1 - 33.0 GHz	± (0.3 + 8%) of Atten. Setting Max		dB
Input Power for 0.1 dB Compression	0.1 - 0.5 GHz		22		dBm
	0.5 - 33.0 GHz		27		dBm
Input Third Order Intercept Point (Two-Tone Input Power= 0 dBm Each Tone)	0.1 - 0.5 GHz		42		dBm
	0.5 - 33.0 GHz		45		dBm
Switching Characteristics	0.1 - 33.0 GHz	tRISE, tFALL (10/90% RF)	60		ns
		tON/tOFF (50% CTL to 10/90% RF)	90		ns
I <sub>dd</sub>	0.1 - 33.0 GHz	2.5	4.5	6.5	mA
I <sub>ss</sub>	0.1 - 33.0 GHz	-7.0	-5.0	-3.0	mA



## 0.5 dB LSB GaAs MMIC 5-BIT DIGITAL ATTENUATOR, 0.1 - 33 GHz

### Insertion Loss vs. Temperature

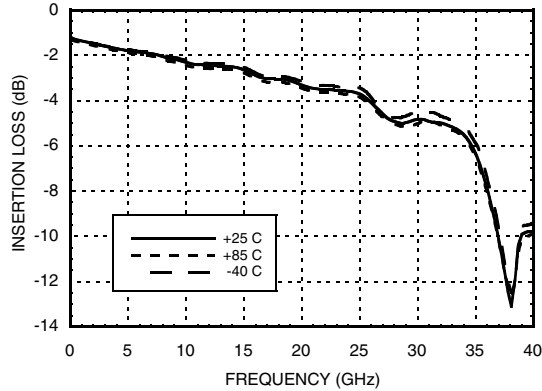

### Normalized Attenuation

(Only Major States are Shown)

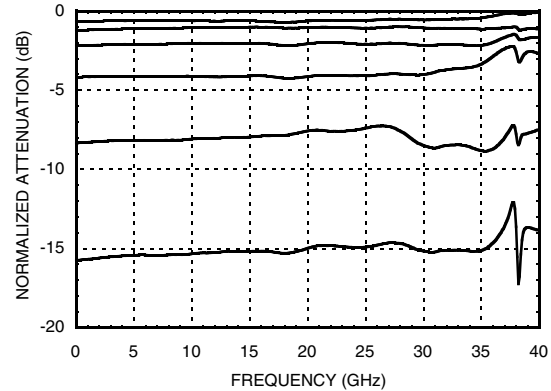

### Input Return Loss

(Only Major States are Shown)

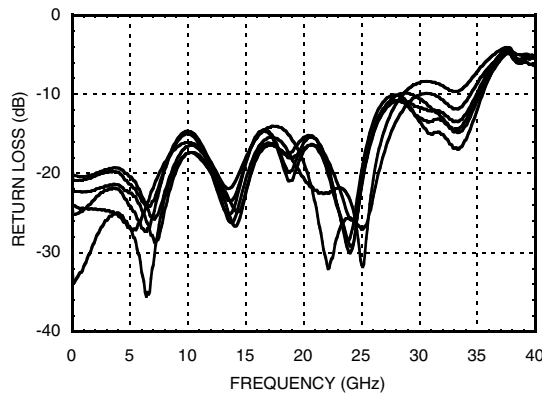

### Output Return Loss

(Only Major States are Shown)

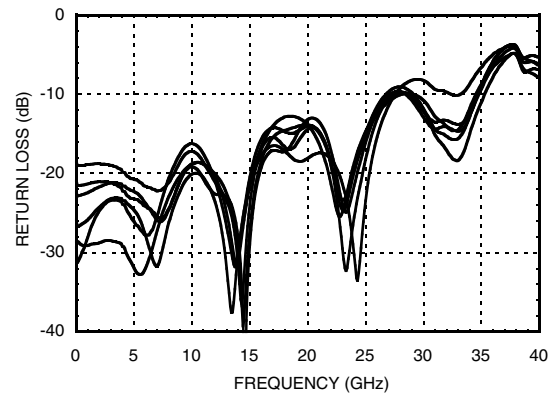

### Bit Error vs. Attenuation State

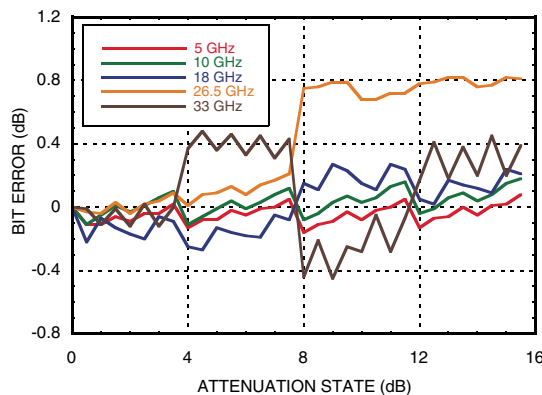

### Bit Error vs. Frequency

(Only Major States are Shown)

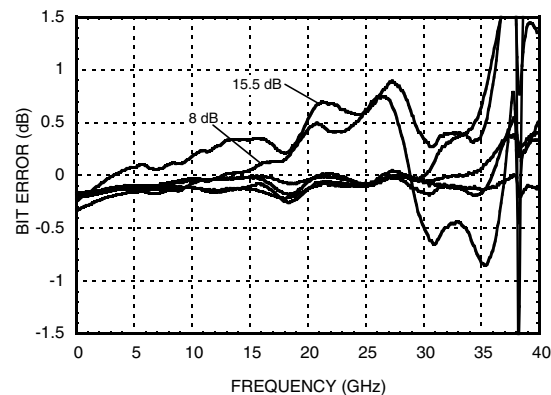



**Relative Phase vs. Frequency**  
(Only Major States are Shown)

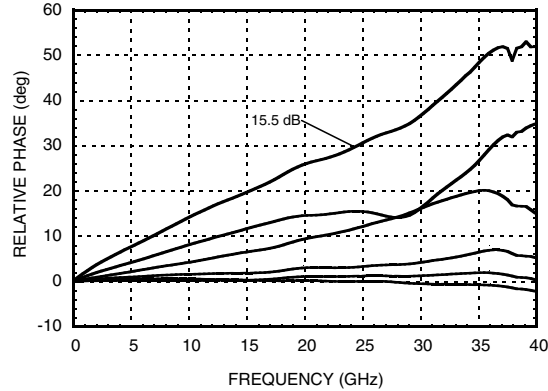

**HMC941LP4 / 941LP4E**

**0.5 dB LSB GaAs MMIC 5-BIT DIGITAL ATTENUATOR, 0.1 - 33 GHz**

**Step Attenuation vs. Attenuation State**  
**0.1 - 18 GHz**

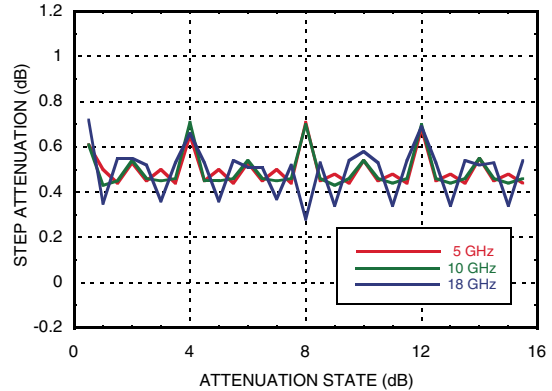

**Step Attenuation vs. Attenuation State**  
**18 - 33 GHz**

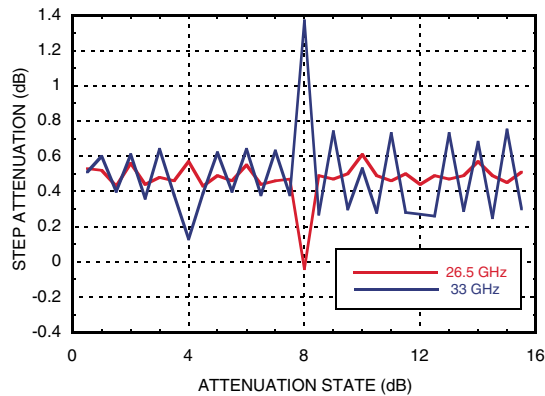

**Input Power for 0.1 dB Compression**

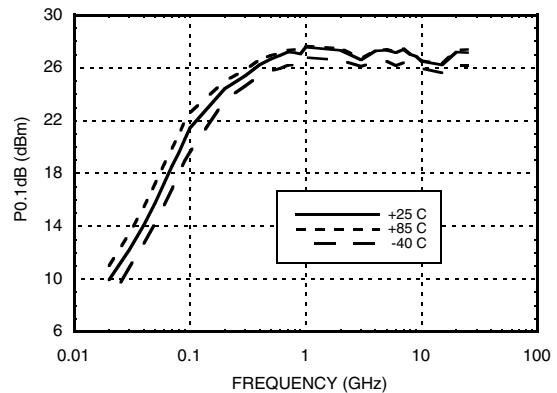

**Input IP3 Over Major Attenuation States**

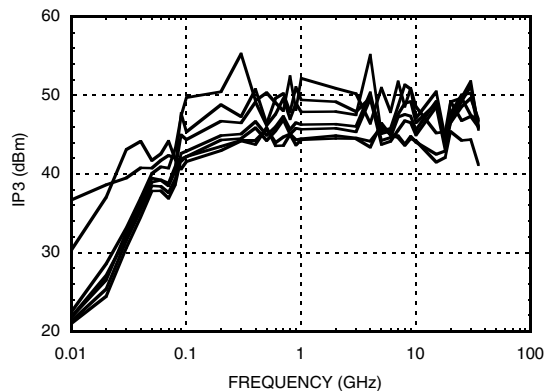

**Input IP3 vs. Temperature**

(Minimum Attenuation State)

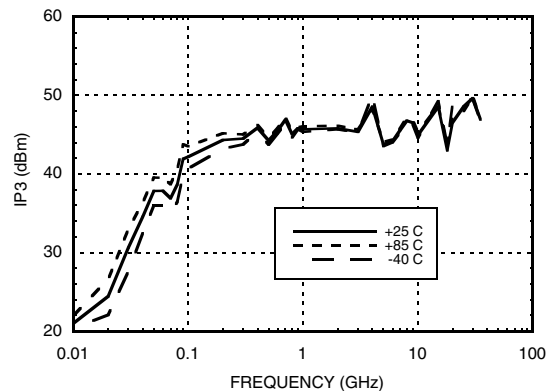

### Absolute Maximum Ratings

RF Input Power (0.1 to 33.0 GHz)	+27 dBm
Control Voltage (P0 to P4)	Vdd + 0.5V
Vdd	+7 Vdc
Vss	-7 Vdc
Channel Temperature	150 °C
Continuous Pdiss (T = 85 °C) (derate 6.8 mW/°C above 85 °C)	0.445 W
Thermal Resistance	146 °C/W
Storage Temperature	-65 to + 150 °C
Operating Temperature	-40 to +85 °C
ESD Sensitivity (HBM)	Class 1A

### Bias Voltages & Currents

Vdd	+5V @ 4.5 mA
Vss	-5V @ 5 mA

### Control Voltage

State	Bias Condition
Low	0 to 0.8V @ 1 μA
High	2 to 5V @ 1 μA



ELECTROSTATIC SENSITIVE DEVICE  
OBSERVE HANDLING PRECAUTIONS

### Outline Drawing

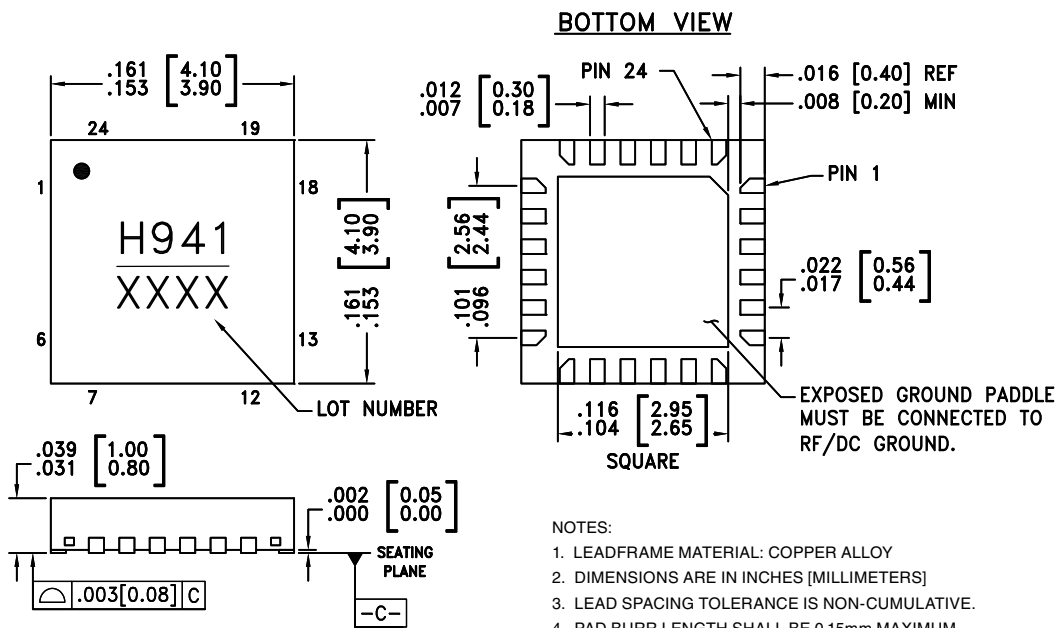

#### NOTES:

- LEADFRAME MATERIAL: COPPER ALLOY
- DIMENSIONS ARE IN INCHES [MILLIMETERS]
- LEAD SPACING TOLERANCE IS NON-CUMULATIVE.
- PAD BURR LENGTH SHALL BE 0.15mm MAXIMUM.  
PAD BURR HEIGHT SHALL BE 0.05mm MAXIMUM.
- PACKAGE WARP SHALL NOT EXCEED 0.05mm.
- ALL GROUND LEADS AND GROUND PADDLE MUST BE SOLDERED TO PCB RF GROUND.
- REFER TO HITTITE APPLICATION NOTE FOR SUGGESTED LAND PATTERN.

### Package Information

Part Number	Package Body Material	Lead Finish	MSL Rating	Package Marking <sup>[3]</sup>
HMC941LP4	Low Stress Injection Molded Plastic	Sn/Pb Solder	MSL1 <sup>[1]</sup>	H941 XXXX
HMC941LP4E	RoHS-compliant Low Stress Injection Molded Plastic	100% matte Sn	MSL1 <sup>[2]</sup>	H941 XXXX

[1] Max peak reflow temperature of 235 °C

[2] Max peak reflow temperature of 260 °C



[3] 4-Digit lot number XXXX



**Truth Table**

Control Voltage Input					Attenuation State RF1 - RF2
P4 8 dB	P3 4 dB	P2 2 dB	P1 1 dB	P0 0.5 dB	
High	High	High	High	High	Reference I.L.
High	High	High	High	Low	0.5 dB
High	High	High	Low	High	1 dB
High	High	Low	High	High	2 dB
High	Low	High	High	High	4 dB
Low	High	High	High	High	8 dB
Low	Low	Low	Low	Low	15.5 dB

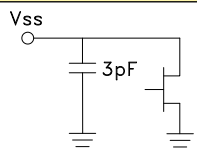
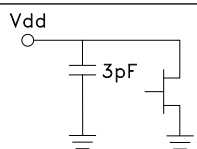
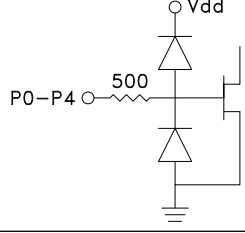
Any Combination of the above states will provide an attenuation approximately equal to the sum of the bits selected.

**Pin Descriptions**

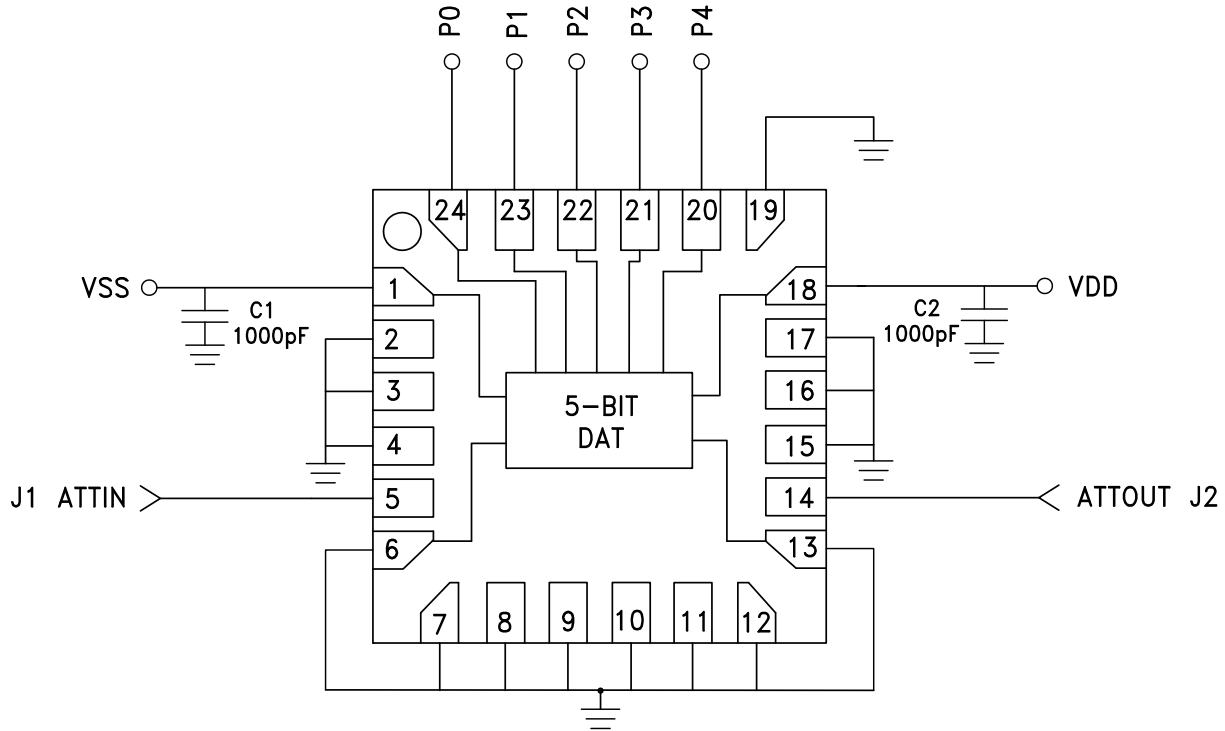
Pad Number	Function	Description	Interface Schematic
1	Vss	Negative Bias -5V	
2-4, 6-13, 15-17, 19	N/C	The pins are not connected internally; however, all data shown herein was measured with these pins connected to RF/DC ground externally.	
5, 14	RF1, RF2	These pins are DC coupled and matched to 50 Ohm. Blocking capacitors are required if RF line potential is not equal to 0V.	
18	Vdd	Positive Bias +5V	
20 - 24	P0 - P4	See truth table and control voltage table.	
	GND	Package bottom must be connected to RF/DC ground.	

**Application Circuit**

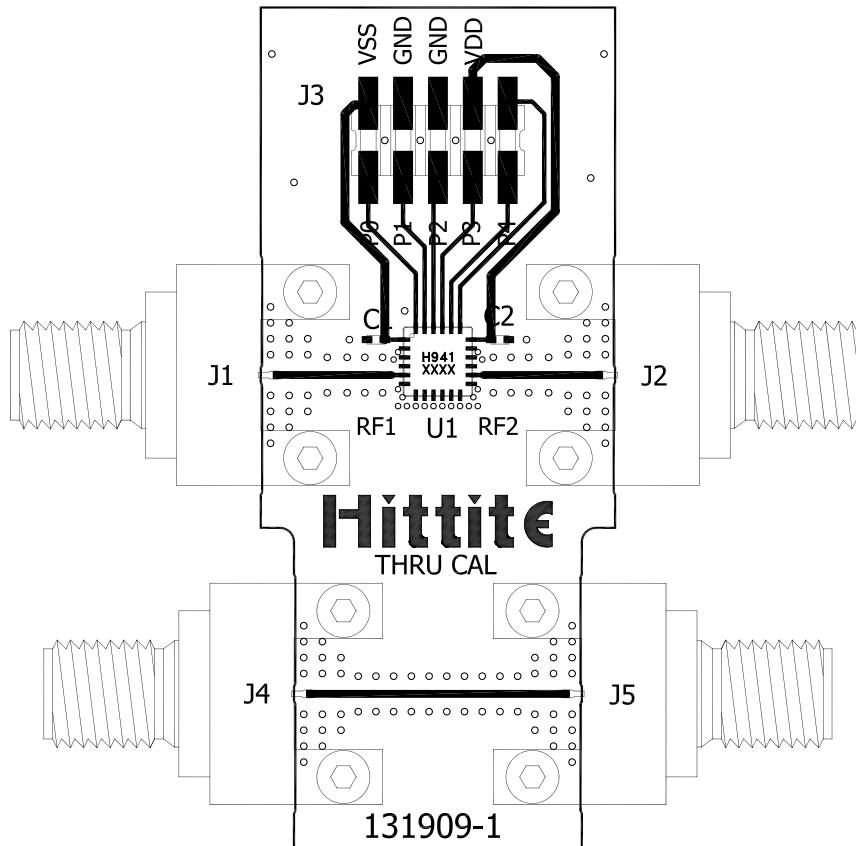
**Evaluation PCB**

**List of Materials for Evaluation PCB 130450 [1]**

Item	Description
J1, J2, J4, J5	2.9 mm PC Mount RF Connector
J3	DC Connector
C1, C2	1000 pF Capacitor, 0402 Pkg.
U1	HMC941LP4 Digital Attenuator
PCB [2]	131909 Evaluation Board

[1] Reference this number when ordering complete evaluation PCB

[2] Circuit Board Material: Rogers 4350

The circuit board used in the application should use RF circuit design techniques. Signal lines should have 50 Ohm impedance while the package ground leads should be connected directly to the ground plane similar to that shown. A sufficient number of via holes should be used to connect the top and bottom ground planes. The evaluation circuit board shown is available from Hittite upon request.



**Notes:**

## HMC941LP4 / 941LP4E

**0.5 dB LSB GaAs MMIC 5-BIT DIGITAL  
ATTENUATOR, 0.1 - 33 GHz**