

PLEASE CHECK WWW.MOLEX.COM FOR LATEST PART INFORMATION

Part Number: [0358572349](#)
Status: **Active**
Overview:
Description: 1.00mm (.039") Pitch FFC Connector, Vertical, Non-ZIF, 23 Circuits, 2.80mm (.110")
 Straight PC Tail, Tube Packaging

Agency Certification

CSA LR19980
 UL E29179

General

Product Family FFC/FPC Connectors
 Series 35857
 Overview ffc_fpc_throughhole
 Product Name N/A

Physical

Circuits (Loaded) 23
 Color - Resin Black
 Contact Position N/A
 Durability (mating cycles max) 10
 Entry Angle Vertical
 Flammability 94V-0
 Mated Height (in) 0.205 In
 Mated Height (mm) 5.20 mm
 Material - Metal Phosphor Bronze
 Material - Plating Mating Tin
 Material - Plating Termination Tin
 Material - Resin Nylon
 Number of Rows 1
 Orientation Vertical
 PC Tail Length (in) 0.110 In
 PC Tail Length (mm) 2.80 mm
 PCB Locator No
 PCB Retention None
 Packaging Type Tube
 Pitch - Mating Interface (in) 0.039 In
 Pitch - Mating Interface (mm) 1.00 mm
 Plating min: Mating (µin) 32.00
 Plating min: Mating (µm) 0.800
 Plating min: Termination (µin) 32.00
 Plating min: Termination (µm) 0.80
 Polarized to PCB No
 Stackable No
 Temperature Range - Operating -20°C to +80°C
 Termination Interface: Style Through Hole
 Wire/Cable Type FFC/FPC

Electrical

Current - Maximum per Contact 0.5A
 Voltage - Maximum 50V

Material Info

Reference - Drawing Numbers

Packaging Specification PK-35857-001
 Product Specification PS-35857-001

EU RoHS

**ELV and RoHS
 Compliant**
**REACH SVHC
 Contains SVHC: No**
**Halogen-Free
 Status**

China RoHS



Not Halogen-Free

**Need more information on product
 environmental compliance?**

Email productcompliance@molex.com
 For a multiple part number RoHS Certificate of
 Compliance, [click here](#)

Please visit the [Contact Us](#) section for any
 non-product compliance questions.

Search Parts in this Series
[35857Series](#)

This document was generated on 06/04/2010

PLEASE CHECK WWW.MOLEX.COM FOR LATEST PART INFORMATION

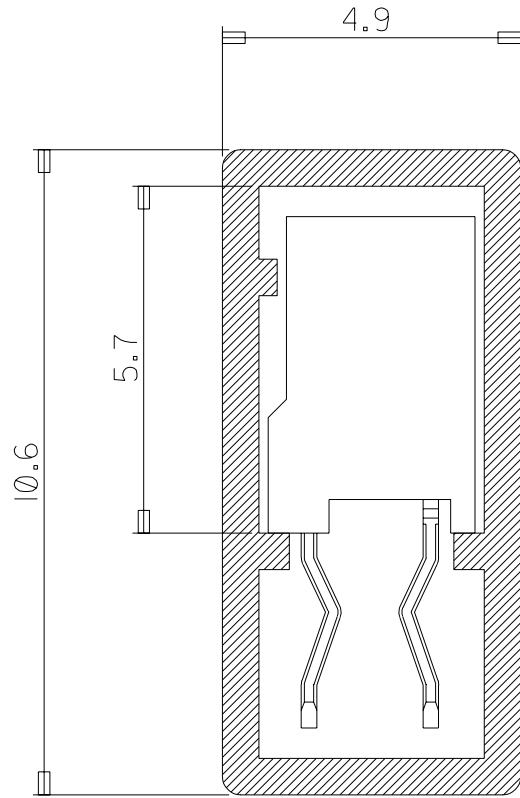

NOTE

1. ENG NO.

HSG ASS'Y	PACKING	SHAPE	
		TAIL	KINK
35857-***11	35857-***19	3.2	0
35857-***21	35857-***29	3.2	X
35857-***31	35857-***39	2.8	0
35857-***41	35857-***49	2.8	X

2. MATERIAL : PVC

3. TUBE LENGTH : 550mm

NEW RELEASED
 KOR2003-0277
 HSSHIN 20030630
 J.K.OH
 C.W.LEE

3

1

8-1 X

H.S.SHIN 99.2.26

J.K.OH 99.2.26

C.W.LEE 99.2.26

15	30
16	29
	28
17	27
	26
18	25
19	24
	23
Q'TY	CKT

20	22
21	21
	20
22	19
24	18
25	17
27	16
28	15
30	14
32	13
34	12
37	11
40	10
43	9
47	8
52	7
57	6
65	5
74	4
85	3
Q'TY	CKT

X

TUBE PACKING
 FOR 35857 SERIES

SD-35857-***41

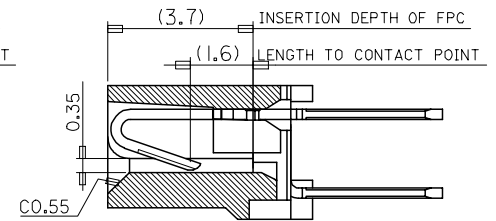
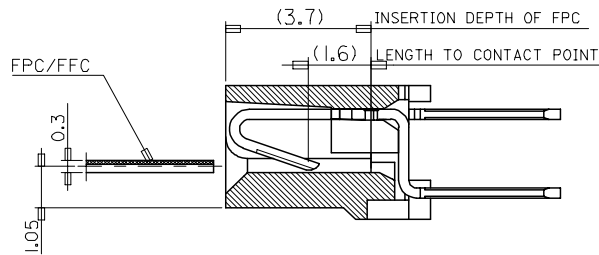
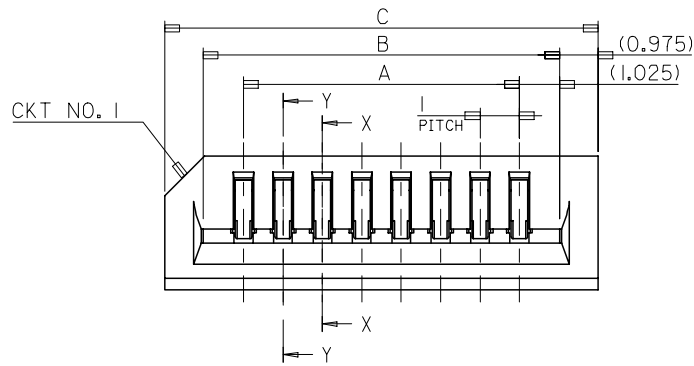

SECTION X-X
(ODD CKT)

SECTION Y-Y
(EVEN CKT)

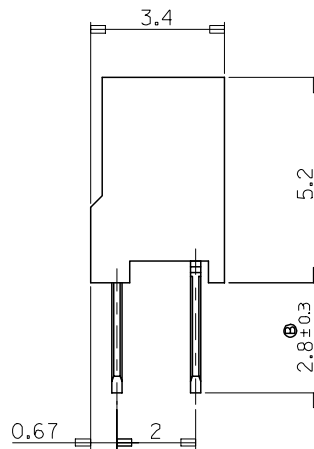
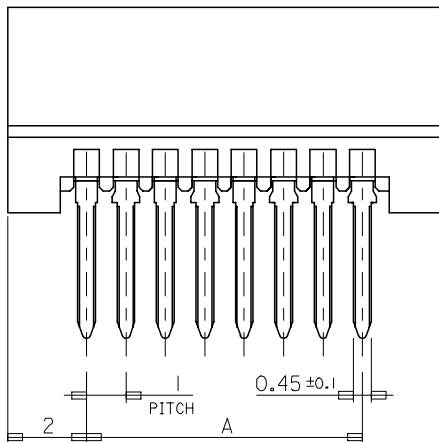

NOTES

- I. MATERIAL
- HOUSING : NYLON66 (UL 94V-0)
(COLOR:BLACK)
- TERMINAL : PHOSPHOR BRONZE
TIN-PLATED

33	31.05	29	35857-3041	30
32	30.05	28	-2941	29
31	29.05	27	-2841	28
30	28.05	26	-2741	27
29	27.05	25	-2641	26
28	26.05	24	-2541	25
27	25.05	23	-2441	24
26	24.05	22	-2341	23
25	23.05	21	-2241	22
24	22.05	20	-2141	21
23	21.05	19	-2041	20
22	20.05	18	-1941	19
21	19.05	17	-1841	18
20	18.05	16	-1741	17
19	17.05	15	-1641	16
18	16.05	14	-1541	15
17	15.05	13	-1441	14
16	14.05	12	-1341	13
15	13.05	11	-1241	12
14	12.05	10	-1141	11
13	11.05	9	-1041	10
12	10.05	8	-0941	9
11	9.05	7	-0841	8
10	8.05	6	-0741	7
9	7.05	5	-0641	6
8	6.05	4	-0541	5
7	5.05	3	-0441	4
6	4.05	2	35857-0341	3
C	B	A	ENG. NO.	CKT. NO.

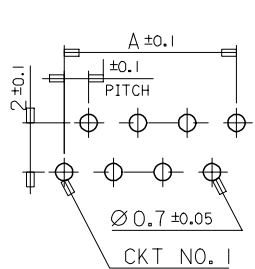

P.C. BOARD LAYOUT
(MOUNTING SIDE)
(THK. : 1.6+)

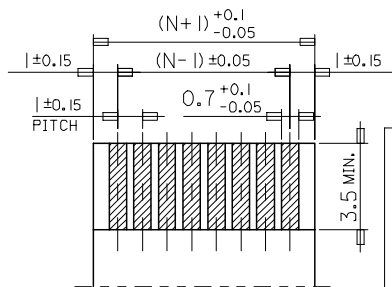

APPLICABLE FPC
(THK. : 0.3 ± 0.03)

ENTER DESCRIPTION
EC NO: KOR2007-0095
DRWN: JHLEE05 2007/02/23
CHKD: KSKIM 2007/02/23
APPR: YUNSIKKIM 2007/02/26

QUALITY SYMBOLS
▽=0
△=0

GENERAL TOLERANCES (UNLESS SPECIFIED)	
mm	INCH
4 PLACES ± ---	± ---
3 PLACES ± ---	± ---
2 PLACES ± ---	± ---
1 PLACE ± 0.2	± ---
ANGULAR ± 1 °	
DRAFT WHERE APPLICABLE MUST REMAIN WITHIN DIMENSIONS	

DIMENSION STYLE
IN/MM

DRAWN BY HS. SHIN DATE 1999/02/26
CHECKED BY JK. OH DATE 1999/02/26
APPROVED BY CW. LEE DATE 1999/02/26

MATERIAL NO.
ENTER PART

SIZE A3

SCALE 1:1

DESIGN UNITS METRIC

THIRD ANGLE PROJECTION

MOLEX

DOCUMENT NO. SD-35857-***41

1.0 FFC CONN.
NON-ZIF ST. SERIES
(03~30 CKTS)

MOLEX INCORPORATED

SHEET NO. 1 OF 00

THIS DRAWING CONTAINS INFORMATION THAT IS PROPRIETARY TO MOLEX INCORPORATED AND SHOULD NOT BE USED WITHOUT WRITTEN PERMISSION