

## DOT MATRIX PRINTER CONTROLLER

**DESCRIPTION** The μPD781 is an LSI Dot Matrix Printer Controller chip which contains all the circuitry and control functions for interfacing an 8-bit processor to the Epson model 512, 522, and 542 Dot Matrix Printers. These printers are capable of printing 40 columns per row with a 5 x 7 dot matrix. The μPD781 is ideally suited for low-cost Electronic Cash Registers (ECR) and Point of Sale (POS) systems because it frees the processor from direct control of the printer and simplifies I/O software.

There are nine separate instructions which the μPD781 will execute. Each of these instructions requires only a single 8-bit byte from the processor to be executed. Upon receipt of the instruction the μPD781 assumes control of the printer, increments the print head, activates the print solenoids, performs line feed on either receipt or journal registers (or both), and performs these operations for an entire print line of 40 columns.

The μPD781 contains its own on-board character generator of 96 symbols. It contains a 40 column printer buffer and is capable of supplying status information to the host processor on both the controller itself as well as the printer. Characters to be printed are written into the μPD781 by the processor, and after the receipt of 40 characters the entire row is printed out with a single print command.

### FEATURES

- Compatible with most Microprocessors including 8080A, 8085A, μPD780 (Z80™)
- Capable of Interfacing to Epson Model 512, 522, or 542 Printers
- Print Technique — Serial Dot Matrix
- Print Font — 5 x 7 Dot Matrix
- Column Print Capacity: 40 Columns for Model 512 and 522; 18 Columns for Receipt and 18 Columns for Journal-Model
- Buffer Capacity: 40 Columns — Model 512 and 522; 2 to 18 Columns — Model 542
- 96 Character Set (Alphanumerics Plus Symbols)
- Print Speed — Approximately 3 Lines/sec (Bidirectional Printing)
- Paper Feed: Independent or Simultaneous; Receipt and Journal Feed; Fast Feed
- Stamp Drive Output — Also Cutter Drive Output and Slip Release for Model 522.
- Sense Printer Status: Validation (Left/Right) Sensor — Model 512 and 522; TOF, BOF Sensor — Model 542; Low Paper Detector — Model 512 and 522
- On-Board 6 MHz Oscillator (External Crystal Required)
- Operates from a Single +5V Power Supply (NMOS Technology)
- Available in 40-Pin Plastic Package

### PIN CONFIGURATION

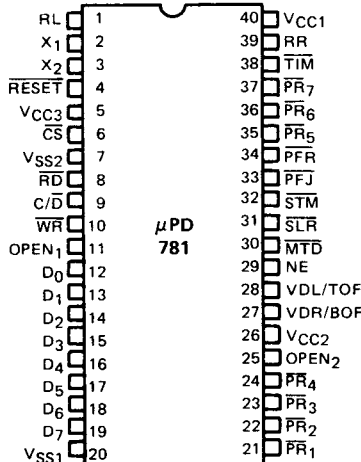

### PIN NAMES

RL	Reset Signal (L)
RR	Reset Signal (R)
X <sub>1</sub> , X <sub>2</sub>	Crystal Inputs
RESET	Reset
CS	Chip Select
RD	Read
C/D	Command/Data
WR	Write
D <sub>0-7</sub>	Data Bus
PR <sub>1-PR7</sub>	Print Solenoids
VDR/BOF	Validation (R)/BOF Sensor
VDL/TOF	Validation (L)/TOP Sensor
NE	Low Paper Detector
MTD	Motor Drive
SLR	Slip Release
STM	Stamp
PFJ	Paper Feed Journal
PFR	Paper Feed Receipt
TIM	Timing Signal

BLOCK DIAGRAM

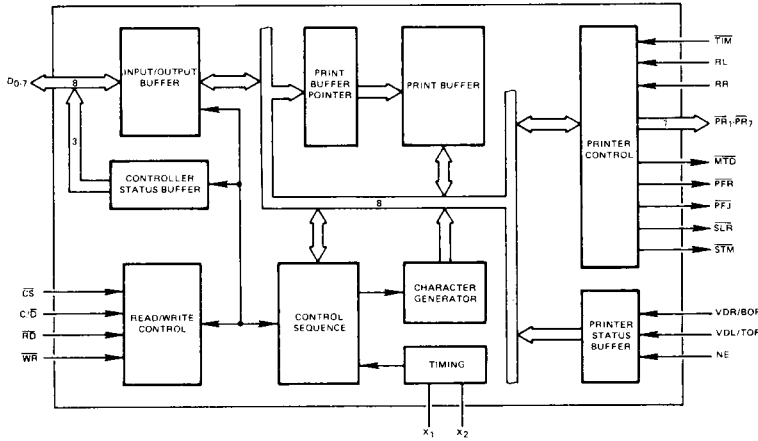

PIN IDENTIFICATION

PIN			I/O	FUNCTION
NUMBER	SYMBOL	NAME		
2, 3	X <sub>1</sub> , X <sub>2</sub>	External Crystal Input	I	This is a connection to external crystal (Frequency: 6 MHz). X <sub>1</sub> could also be used as input for external oscillator.
4	RESET	Reset	I	The Reset signal initializes the μPD781. When RESET = 0, the buffer and register contents are: Bus Buffer – (IOM-1, IOB=PSR=0). Column Buffer – All characters in this buffer become 20 <sub>(16)</sub> (ASCII). Column Buffer Pointer – It indicates the left side of the buffer. Column Capacity – 40 columns. Print Head – Current Position.
6	CS	Chip Select	I	If the Chip Select is 0 when the data bus becomes active, it enables the transfer of data between the processor and the μPD781 via the data bus. If it is 1, the data bus goes into High-Impedance state (inactive). However, the operation of the printer is not affected when CS=1.
8	RD	Read	I	The Read Control Signal is used to read controller status or printer status to the host processor. When RD=1, status information is presented.
10	WR	Write	I	The Write Control Signal is used to write commands or print data to the μPD781. When WR=0, data on the data bus is written into the μPD781.
9	C/D	Command/Data Select	I	The C/D Select is used to indicate what kind of data is being input/output on the data bus by the host processor. When C/D=1 in Read Operation, it is a Controller Status and in Write Operation it gives commands. When C/D=0 in Read Operation it is a Printer Status and in Write Operation it is print data.

**PIN IDENTIFICATION  
(CONT.)**

NUMBER	PIN		I/O	FUNCTION
	SYMBOL	NAME		
12-19	D <sub>0-7</sub>	Data Bus	I/O 3-State	It is an 8-bit bi-directional data bus and is used to transfer the data between the host processor and the μPD781.
5,26, 40	V <sub>CC1-3</sub>	DC Power		These are connected to +5V power supply.
7,20	V <sub>SS1-2</sub>	Signal Ground		
11,25	OPEN <sub>1-2</sub>	No Connection		These pins must be open. Do not connect them to +5V, GND or any other signals.
21-24, 35-37	$\overline{PR}_1\text{-}\overline{PR}_7$	Print Solenoid	O	These are drive signals for the print solenoids. When these signals are 0, the print solenoid should be activated. They are synchronized with the timing signal (TIM), which is issued from the printer.
38	$\overline{TIM}$	Timing Signal	I	The timing signal is issued from the printer. It is used to generate and synchronize all the basic printer operations such as paper feed, paper cut, etc.
1	RL	Reset Signal Left	I	The reset signal (RL=1) is issued by the printer and indicates that the print-head is positioned at the left margin.
39	RR	Reset Signal Right	I	The reset signal (RR=1) is issued by the printer and indicates that the print-head is positioned at the right margin.
30	$\overline{MTD}$	Motor Drive	O	The motor drive signal is issued to the printer, and is active during low state.
34	$\overline{PFR}$	Paper Feed Receipt	O	This is the drive signal for the paper feed magnet and is active during low state. In Model 512 and 542 it is used as a paper feed magnet drive signal, and in Model 522 it is used as a receipt paper feed magnet drive signal.
33	$\overline{PFJ}$	Paper Feed Journal	O	This is the drive signal for the journal paper feed and is active during low state. It is used only with Model 522, and is not used at all in Model 512 and 542.
32	$\overline{STM}$	Stamp	O	This is the drive signal for both the stamp magnet and the paper cutter and is active during the low state. This signal is used only with Model 522. If partial-cut or stamp and full-cut are required, they may be implemented by using the Fast Feed command which is synchronized with each timing pulse before it is output. This signal is not used in the Model 512 and 542.
31	$\overline{SLR}$	Slip Release	O	This is the drive signal for the slip release magnet and is active during low state. It is used only with Model 542, and is active only during the Print command or Fast Feed command. This signal is not used in the Model 512 and 522.
27	VDR/BOF	Validation Right/BOF Sensor ①	I	In Model 512 and 522, the Validation Right signal (VDR) is used to detect when the print-head is located at the right side of the paper. In Model 542, the BOF Sensor signal (BOF) is used to detect the end of the paper.
28	VDL/TOF	Validation Left/TOF Sensor ①	I	In Model 512 and 522, the Validation Left signal (VDL) is used to detect when the print-head is located at the left side of the paper. In Model 542, the TOF Sensor signal (TOF) is used to detect the top of the paper.
29	NE	Low Paper Detector ①	I	This signal is used to indicate a low paper condition and is active in high state.

Note: ① The VDR/BOF, VDL/TOF and NE signals are available on the data bus when a Printer Status is requested by the host processor. The μPD781 passes these signals onto the host processor.

# μPD781

Operating Temperature ..... 0°C to +70°C  
 Storage Temperature ..... -65°C to +125°C  
 Voltage On Any Pin ..... -0.5 to +7 Volts<sup>①</sup>

## ABSOLUTE MAXIMUM RATINGS\*

Note: ① With Respect to Ground.

COMMENT: Stresses above those listed under "Absolute Maximum Ratings" may cause permanent damage to the device. This is a stress rating only and functional operation of the device at these or any other conditions above those indicated in the operational sections of this specification is not implied. Exposure to absolute maximum rating conditions for extended periods may affect device reliability.

\*T<sub>a</sub> = 25°C

T<sub>a</sub> = 0°C to +70°C; V<sub>CC1-3</sub> = +5V ± 5%; V<sub>SS1-2</sub> = 0V

## DC CHARACTERISTICS

PARAMETER	SYMBOL	LIMITS			UNIT	TEST CONDITIONS
		MIN	TYP	MAX		
Input High Voltage (All except XTAL 1, XTAL 2, RESET)	V <sub>IH1</sub>	2.0		V <sub>CC</sub>	V	
Input High Voltage (XTAL 1, XTAL 2, RESET)	V <sub>IH2</sub>	3.5		V <sub>CC</sub>	V	
Input Low Voltage (All except XTAL 1, XTAL 2)	V <sub>IL</sub>	-0.5		0.8	V	
Output High Voltage (D <sub>0-7</sub> )	V <sub>OH1</sub>	2.4			V	I <sub>OH</sub> = -400 μA
Output High Voltage (All Other Outputs)	V <sub>OH2</sub>	2.4			V	I <sub>OH</sub> = -50 μA
Output Low Voltage (D <sub>0-7</sub> )	V <sub>OL1</sub>			0.45	V	I <sub>OL</sub> = 2.0 mA
Output Low Voltage (All Other Outputs except D <sub>0-7</sub> )	V <sub>OL2</sub>			0.45	V	I <sub>OL</sub> = 1.6 mA
Low Input Source Current (VDR/BOF, VDL/TOF, NE, TIM)	I <sub>LI1</sub>			0.4	mA	V <sub>IL</sub> = 0.8V
Low Input Source Current (RESET)	I <sub>LI2</sub>			*0.2	mA	V <sub>IL</sub> = 0.8V
Input Leakage Current (RL, RR, RD, WR, CS, C/D)	I <sub>IL</sub>			±10	μA	V <sub>SS</sub> ≤ V <sub>IN</sub> ≤ V <sub>CC</sub>
Output Leakage Current (D <sub>0-7</sub> , High Impedance State)	I <sub>OL</sub>			±10	μA	V <sub>SS</sub> + 0.45 ≤ V <sub>IN</sub> ≤ V <sub>CC</sub>
Total Supply Current (I <sub>CC1</sub> + I <sub>CC2</sub> + I <sub>CC3</sub> )	I <sub>CC</sub>		65	135	mA	T <sub>a</sub> = 25°C

**AC CHARACTERISTICS**

T<sub>a</sub> = 0°C to 70°C; V<sub>CC1-3</sub> = +5V ± 5%; V<sub>SS1-2</sub> = 0V

PARAMETER	SYMBOL	LIMITS			UNIT	TEST CONDITIONS
		MIN	TYP	MAX		
<b>READ OPERATION</b>						
$\overline{CS}, C/\overline{D}$ Setup to $\overline{RD} \downarrow$	t <sub>AR</sub>	0			ns	D <sub>0-7</sub> Input
$\overline{CS}, C/\overline{D}$ Hold After $\overline{RD} \uparrow$	t <sub>RA</sub>	0			ns	
$\overline{RD}$ Pulse Width	t <sub>RR</sub>	250		5000	ns	
$\overline{CS}, C/\overline{D}$ to Data Out Delay	t <sub>AD</sub>			180	ns	
$\overline{RD} \downarrow$ to Data Out Delay	t <sub>RD</sub>			180	ns	
$\overline{RD} \uparrow$ to Data Float Delay	t <sub>DF</sub>	10		100	ns	
Recovery Time Between Reads And/Or Write	t <sub>RV</sub>	1			μs	
<b>WRITE OPERATION</b>						
$\overline{CS}, C/\overline{D}$ Setup to $\overline{WR} \downarrow$	t <sub>AW</sub>	0			ns	D <sub>0-7</sub> Output C <sub>L</sub> = 100 pF
$\overline{CS}, C/\overline{D}$ Hold After $\overline{WR} \uparrow$	t <sub>WA</sub>	0			ns	
$\overline{WR}$ Pulse Width	t <sub>WW</sub>	250		5000	ns	
Data Setup to $\overline{WR} \uparrow$	t <sub>DW</sub>	150			ns	
Data Hold After $\overline{WR} \uparrow$	t <sub>WD</sub>	0			ns	
<b>PRINT OPERATION</b>						
$\overline{TIM} \downarrow$ to $\overline{PR}_{1-7} \downarrow$ Delay	t <sub>TP</sub>			167.5	μs	6 MHz Crystal
$\overline{PR}_{1-7}$ Pulse Width	t <sub>PP</sub>		600		μs	
$\overline{TIM} \downarrow$ to $\overline{PFJ}, \overline{PFR} \downarrow$ Delay	t <sub>TF1</sub>			140	μs	
$\overline{TIM} \downarrow$ to $\overline{PFJ}, \overline{PFR} \uparrow$ Delay	t <sub>TF2</sub>			127.5	μs	
$\overline{TIM} \downarrow$ to $\overline{SLR} \downarrow$ Delay	t <sub>TR1</sub>			60	μs	
$\overline{TIM} \downarrow$ to $\overline{SLR} \uparrow$ Delay	t <sub>TR2</sub>			50	μs	
$\overline{TIM} \downarrow$ to $\overline{STM} \downarrow$ Delay	t <sub>TS1</sub>			72.5	μs	
$\overline{TIM} \downarrow$ to $\overline{STM} \uparrow$ Delay	t <sub>TS2</sub>			37.5	μs	

**PACKAGE OUTLINE**  
μPD781C

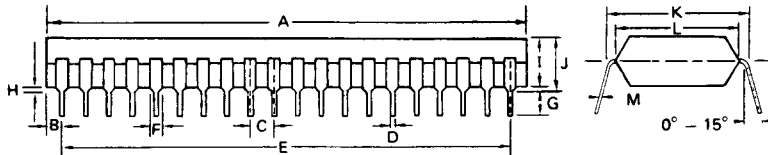

ITEM	MILLIMETERS	INCHES
A	51.5 MAX	2.028 MAX
B	1.62	0.064
C	2.54 ± 0.1	0.10 ± 0.004
D	0.5 ± 0.1	0.019 ± 0.004
E	48.26	1.9
F	1.2 MIN	0.047 MIN
G	2.54 MIN	0.10 MIN
H	0.5 MIN	0.019 MIN
J	5.22 MAX	0.206 MAX
J	5.72 MAX	0.225 MAX
K	15.24	0.600
L	13.2	0.520
M	0.25 0.05	0.010 + 0.004 - 0.002

**TIMING WAVEFORMS**

**READ OPERATION**

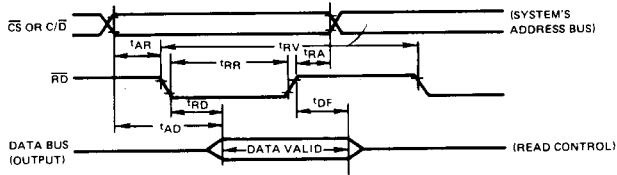

**WRITE OPERATION**

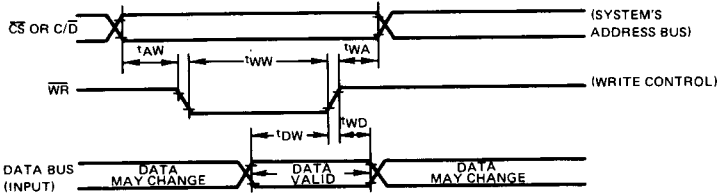

**PRINT OPERATION**

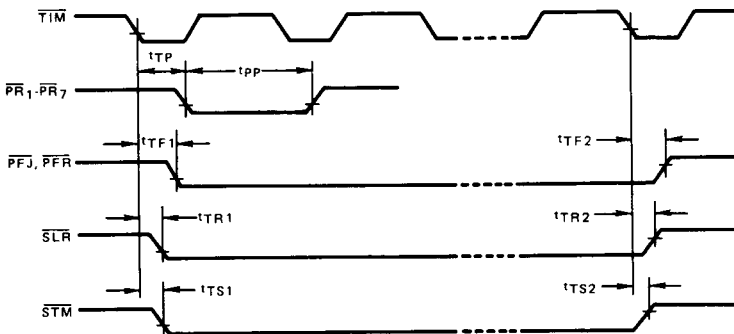

**COMMANDS** All transfer of information between the μPD781 and the host processor is via the data bus, and the four (4) control signals,  $\overline{CS}$ ,  $C/\overline{D}$ ,  $\overline{WR}$  and  $\overline{RD}$ . The four control signals determine what type of data transfer will occur on the data bus.

$\overline{CS}$	$C/\overline{D}$	$\overline{RD}$	$\overline{WR}$	DATA BUS	OPERATION
0	0	0	0	—	Inhibited
0	0	1	0	Print Data	Write Data into Column Buffer
0	0	0	1	Printer Status	Read Printer Status
0	0	1	1	—	No Operation
0	1	0	0	—	Inhibited
0	1	1	0	Command	Write Command for Printer
0	1	0	1	Controller Status	Read Controller Status
0	1	1	1	—	No Operation
1	X	X	X	—	Disable μPD781

Before issuing any new command or loading new data into the column buffer, the host processor should check the controller status bits IOM, IOB and PSR. No new operation should be performed if IOB bit indicates that the μPD781 is busy.

**Controller Status Register**

X	X	X	X	X	IOM	IOB	PSR
---	---	---	---	---	-----	-----	-----

**Printer Status Register**

X	X	X	X	R	S	T	U
---	---	---	---	---	---	---	---

COMMAND		DATA BUS							
		DB7	DB6	DB5	DB4	DB3	DB2	DB1	DB0
Initialize		0	0	0	L/R	x	x	x	x
Request Printer Status		0	0	1	x	x	x	x	x
Printer Format		0	1	b <sub>1</sub>	b <sub>0</sub>	x	x	x	x
Increment Column Printer		0	1	1	1	n <sub>3</sub>	n <sub>2</sub>	n <sub>1</sub>	n <sub>0</sub>
Print	Model 512 and 542	1	0	0	0	x	LF	x	SR
	Model 522	1	0	a <sub>1</sub>	a <sub>0</sub>	LFJ	LFR	x	x
Fast Feed		1	1	c <sub>1</sub>	c <sub>0</sub>	n <sub>3</sub>	n <sub>2</sub>	n <sub>1</sub>	n <sub>0</sub>
Write Print Data		x	d <sub>6</sub>	d <sub>5</sub>	d <sub>4</sub>	d <sub>3</sub>	d <sub>2</sub>	d <sub>1</sub>	d <sub>0</sub>

Note: X = Not Acceptable

**CONTROLLER STATUS REGISTER****COMMAND SYMBOLS  
(CONT.)****IOM – Input/Output Buffer Mode**

The IOM flag indicates the direction of data on the data bus. If IOM=1 data is from processor to μPD781 (write into μPD781). If IOM=0 data is from μPD781 to processor (read from μPD781). Immediately after reading printer status, IOM goes from 0 to 1.

**IOB – Input/Output Buffer Busy**

The IOB flag indicates when the I/O buffer is busy and an operation is in process. If IOB=1 I/O buffer is busy and no new command should be performed. If IOB=0 μPD781 is ready to accept new command.

**PSR – Printer Status Ready**

The PSR flag indicates that the printer status may be read by the processor. If PSR=1 printer status is ready to be read by processor. If PSR=0 printer status is not ready.

**PRINTER STATUS REGISTER****R – Location of Print Head**

R=1 Print Head located at left side of carriage.  
R=0 Print Head located at right side of carriage.

R	S ①	T ①	U ①	OPERATION
x	x	x	1	Detection of R/BOF Sensor
x	x	1	x	Detection of L/TOF Sensor
x	1	x	x	Detection of Low Paper (NE)

Note: ① These bits could have other meanings depending on the signals connected to pins 27, 28, 29.

**INITIALIZE COMMAND**

This command is similar to the RESET command, but it also allows to position the print head.

**L/R – Print Head Left/Right Side**

L/R=1 Print Head is positioned at the left side.  
L/R=0 Print Head is positioned at the right side.

Contents of column buffer is set to 20 hexadecimal (equal to blank), reset condition.

**REQUEST PRINTER STATUS COMMAND**

This command will latch the status of the printer in the internal register. It must be followed by a Printer Status Read Operation. No other command will be accepted until the printer status is read.



COMMAND SYMBOLS  
(CONT.)

PRINTER FORMAT COMMAND

This command sets the controller for the appropriate printer model.

b1,b0 – Format for Column Buffer

b1	b0	COLUMN FORMAT	MODEL PRINTER	COMMENTS
0	0	40 columns	512 or 542	Column Buffer Set at 40 Column
0	1	18 columns	522	Both Receipt and Journal Print Identical 18 Column
1	0	2 x 18 columns	522	Receipt and Journal Print Separate 18 Columns, With Receipt First and Journal Second

INCREMENT COLUMN POINTER COMMAND

The column pointer within the buffer is incremented to the right by the binary value indicated by n0 through n3. In the case of the 2 x 18 column format for the Model 522, the pointer can only move within the receipt or journal side, depending upon which side it is presently located.

PRINT COMMAND

The entire column buffer is printed and after the print operation is complete the contents of the buffer are reset to 20 hexadecimal (blank). During the execution of the print command no other commands are executed.

Models 512 and 542

LF	SR	OPERATION
0	0	Print Only
0	1	After Printing Perform Slip Release Only
1	0	After Printing Perform Line Feed Only
1	1	After Printing Perform Both Line Feed and Slip Release

Model 522

a1	a0	OPERATION
0	1	Print Receipt Only
1	0	Print Journal Only
1	1	Print Receipt and Journal

Model 522

LFJ	LFR	OPERATION
0	0	Print Only
0	1	After Printing Perform Line Feed on Receipt Only
1	0	After Printing Perform Line Feed on Journal Only
1	1	After Printing Perform Line Feed on Both Receipt and Journal

FAST FEED COMMAND

The binary number indicated by n0 through n3 determines the number of continuous line feeds which will be performed. After the last line feed, the contents of the column buffer is reset to 20 hexadecimal (blank). During this operation no other commands are accepted.

c1	c0	OPERATION	MODEL
0	0	Performs Fast Feed Only	512,522,542
0	1	After Fast Feed, Perform Partial Cut	522
1	0	After Fast Feed, Perform Stamp and Full Cut	522
1	1	After Fast Feed, Perform Slip Release	542

# μPD781

## WRITE PRINT DATA COMMAND

## COMMAND SYMBOLS (CONT.)

After each character is written into the column buffer, the column printer is incremented by one. Do not exceed the column capacity defined in the printer format command. The following table defines the relationship between print data (d<sub>0</sub> through d<sub>6</sub>) and the character set.

				(MSB)						
				d <sub>6</sub>	0	0	1	1	1	1
				d <sub>5</sub>	1	1	0	0	1	1
				d <sub>4</sub>	0	1	0	1	0	1
d <sub>3</sub>	d <sub>2</sub>	d <sub>1</sub>	(LSB) d <sub>0</sub>		2	3	4	5	6	7
0	0	0	0	0	0	Q	Q	P	Q	Q
0	0	0	1	1	"	I	A	Q	P	#
0	0	1	0	2	"	B	E	R	Y	W
0	0	1	1	3	#	3	C	S	U	T
0	1	0	0	4	#	4	D	T	I	R
0	1	0	1	5	%	5	E	U	K	T
0	1	1	0	6	#	6	F	V	U	二
0	1	1	1	7	#	7	G	W	#	三
1	0	0	0	8	U	8	H	X	U	#
1	0	0	1	9	E	9	I	Y	U	U
1	0	1	0	A	*	三	J	Z	U	U
1	0	1	1	B	+	4	K	U	#	E
1	1	0	0	C	,	%	L	U	U	U
1	1	0	1	D	-	#	M	U	U	U
1	1	1	0	E	.	U	N	V	U	#
1	1	1	1	F	/	U	O	U	U	U

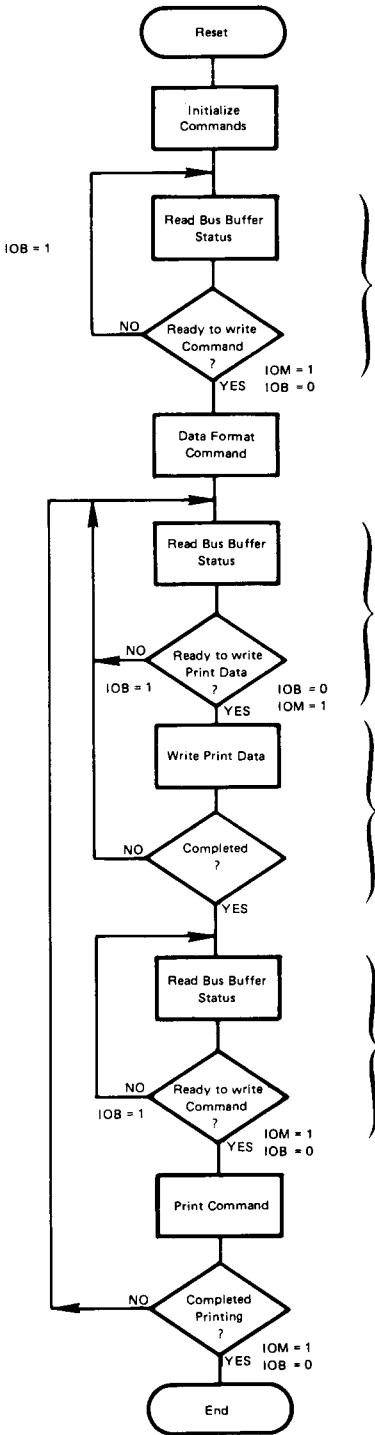

Power-on Reset

Initialize the μPD781. (Reset the Column Buffer and set the Print-Head at the left/right side.)

Check the Bus Buffer Status.

Indicate the format of the Column Buffer. (40 columns, 18 columns x 1, 18 columns x 2.)

Check the Bus Buffer Status.

Write up to maximum number of characters into the column buffer.

Check the Bus Buffer Status.

Print the entire contents of the column buffer. Indicate "Line Feed" or "Slip Release."