

MECHANICAL DATA

**GOLD METALLISED
MULTI-PURPOSE SILICON
DMOS RF FET
400W – 28V – 108MHz
PUSH-PULL**

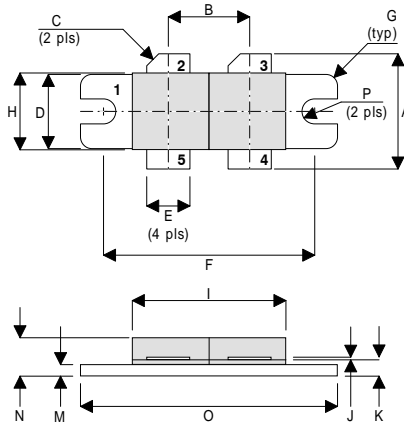

DR

PIN 1 SOURCE (COMMON) PIN 2 DRAIN 1
 PIN 3 DRAIN 2 PIN 4 GATE 2
 PIN 5 GATE 1

DIM	Millimetres	Tol.	Inches	Tol.
A	19.05	0.50	0.75	0.020
B	10.77	0.13	0.424	0.005
C	45°	5°	45°	5°
D	9.78	0.13	0.385	0.005
E	5.71	0.13	0.225	0.005
F	27.94	0.13	1.100	0.005
G	1.52R	0.13	0.060R	0.005
H	10.16	0.13	0.400	0.005
I	22.22	MAX	0.875	MAX
J	0.13	0.02	0.005	0.001
K	2.72	0.13	0.107	0.005
M	1.70	0.13	0.067	0.005
N	5.08	0.50	0.200	0.020
O	34.03	0.13	1.340	0.005
P	1.61R	0.08	0.064R	0.003

FEATURES

- SIMPLIFIED AMPLIFIER DESIGN
- SUITABLE FOR BROAD BAND APPLICATIONS
- LOW C_{rss}
- SIMPLE BIAS CIRCUITS
- LOW NOISE
- HIGH GAIN – 16 dB MINIMUM

APPLICATIONS

- VHF FM COMMUNICATIONS

ABSOLUTE MAXIMUM RATINGS ($T_{case} = 25^{\circ}C$ unless otherwise stated)

P_D	Power Dissipation	438W
BV_{DSS}	Drain – Source Breakdown Voltage *	70V
BV_{GSS}	Gate – Source Breakdown Voltage *	$\pm 20V$
$I_{D(sat)}$	Drain Current *	35A
T_{stg}	Storage Temperature	-65 to 150°C
T_j	Maximum Operating Junction Temperature	200°C

* Per Side

Semelab Plc reserves the right to change test conditions, parameter limits and package dimensions without notice. Information furnished by Semelab is believed to be both accurate and reliable at the time of going to press. However Semelab assumes no responsibility for any errors or omissions discovered in its use. Semelab encourages customers to verify that datasheets are current before placing orders.

ELECTRICAL CHARACTERISTICS ($T_{case} = 25^{\circ}\text{C}$ unless otherwise stated)

Parameter	Test Conditions	Min.	Typ.	Max.	Unit
PER SIDE					
BV_{DSS}	Drain–Source Breakdown Voltage	$V_{GS} = 0$	$I_D = 100\text{mA}$	70	V
I_{DSS}	Zero Gate Voltage Drain Current	$V_{DS} = 28\text{V}$	$V_{GS} = 0$		7 mA
I_{GSS}	Gate Leakage Current	$V_{GS} = 20\text{V}$	$V_{DS} = 0$		7 μA
$V_{GS(th)}$	Gate Threshold Voltage*	$I_D = 10\text{mA}$	$V_{DS} = V_{GS}$	1	7 V
g_{fs}	Forward Transconductance*	$V_{DS} = 10\text{V}$	$I_D = 7\text{A}$	5.6	S
TOTAL DEVICE					
G_{PS}	Common Source Power Gain	$P_O = 400\text{W}$		16	dB
η	Drain Efficiency	$V_{DS} = 28\text{V}$	$I_{DQ} = 2\text{A}$	65	%
VSWR	Load Mismatch Tolerance	$f = 108\text{MHz}$		20:1	—
PER SIDE					
C_{iss}	Input Capacitance	$V_{DS} = 28\text{V}$	$V_{GS} = -5\text{V}$	$f = 1\text{MHz}$	380 pF
C_{oss}	Output Capacitance	$V_{DS} = 28\text{V}$	$V_{GS} = 0$	$f = 1\text{MHz}$	180 pF
C_{rss}	Reverse Transfer Capacitance	$V_{DS} = 28\text{V}$	$V_{GS} = 0$	$f = 1\text{MHz}$	10 pF

* Pulse Test: Pulse Duration = 300 μs , Duty Cycle $\leq 2\%$

HAZARDOUS MATERIAL WARNING

The ceramic portion of the device between leads and metal flange is beryllium oxide. Beryllium oxide dust is highly toxic and care must be taken during handling and mounting to avoid damage to this area.

THESE DEVICES MUST NEVER BE THROWN AWAY WITH GENERAL INDUSTRIAL OR DOMESTIC WASTE.

THERMAL DATA

$R_{THj-case}$	Thermal Resistance Junction – Case	Max. 0.4 $^{\circ}\text{C} / \text{W}$
----------------	------------------------------------	--

Semelab Plc reserves the right to change test conditions, parameter limits and package dimensions without notice. Information furnished by Semelab is believed to be both accurate and reliable at the time of going to press. However Semelab assumes no responsibility for any errors or omissions discovered in its use. Semelab encourages customers to verify that datasheets are current before placing orders.

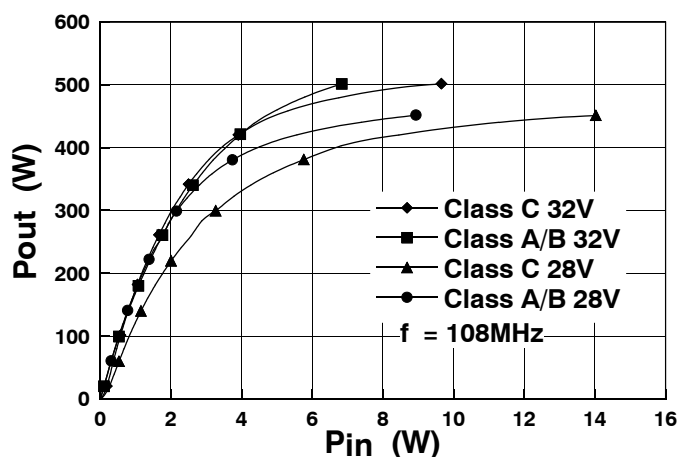

Figure 1
Output Power vs. Input Power

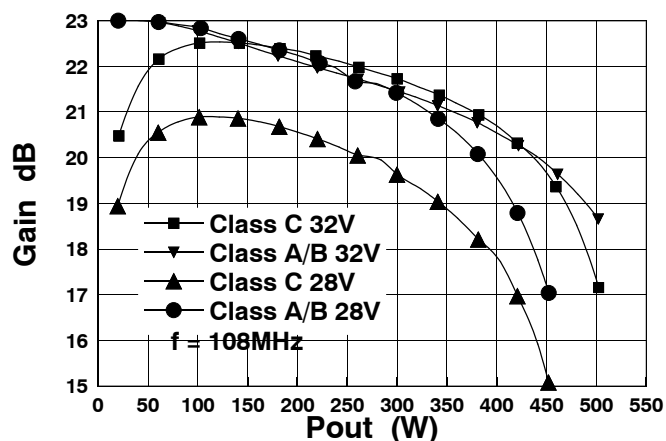

Figure 2
Gain vs. Output Power

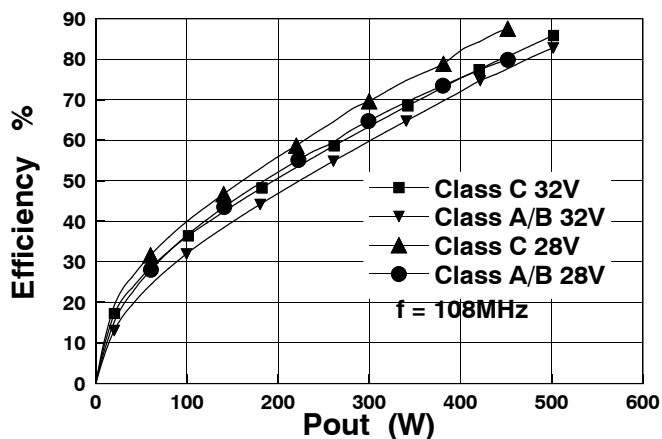

Figure 3
Efficiency vs. Output Power

OPTIMUM SOURCE AND LOAD IMPEDANCE

Frequency MHz	Z_S Ω	Z_L Ω
108	$1.5 + j3.5$	$1.5 - j0.4$

APPLICATION NOTE

In applications where a constant output power is required irrespective of variations in temperature or supply voltage etc. then a feedback loop must be incorporated whereby the drain voltage is adjusted to maintain constant output power.

Semelab Plc reserves the right to change test conditions, parameter limits and package dimensions without notice. Information furnished by Semelab is believed to be both accurate and reliable at the time of going to press. However Semelab assumes no responsibility for any errors or omissions discovered in its use. Semelab encourages customers to verify that datasheets are current before placing orders.

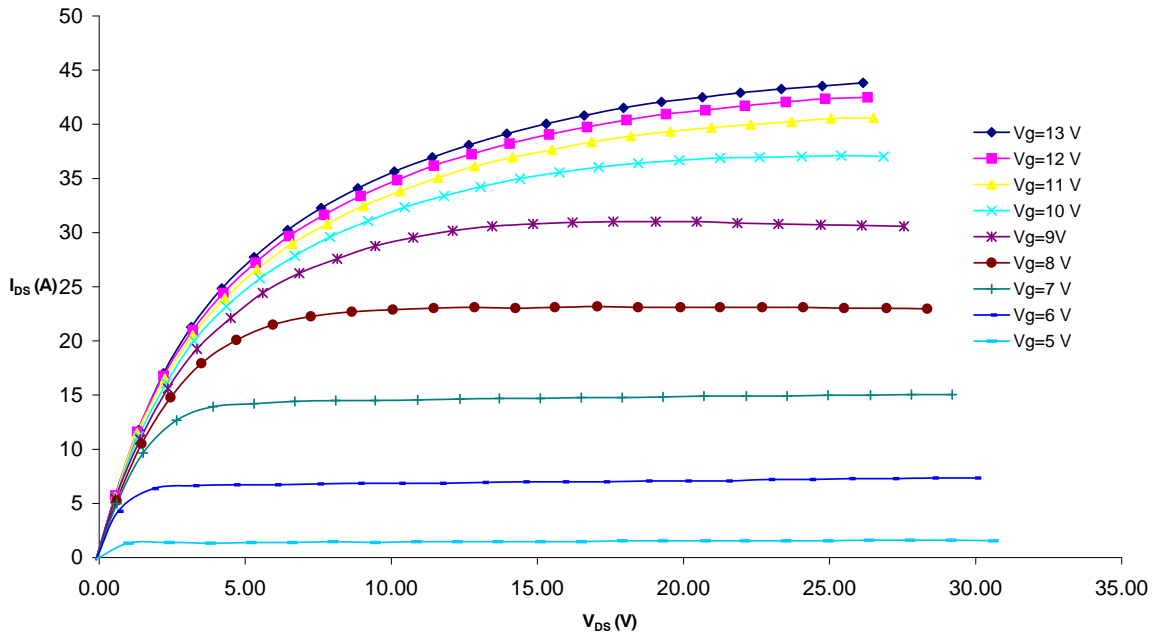

Figure 4 – Typical IV Characteristics.

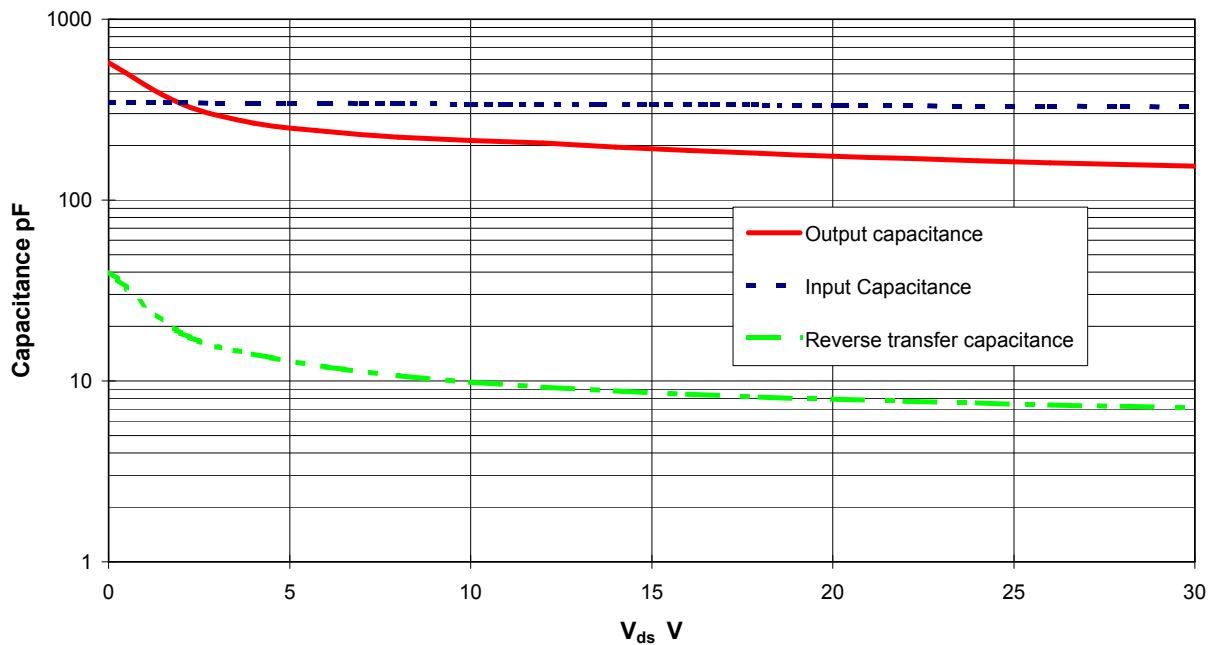
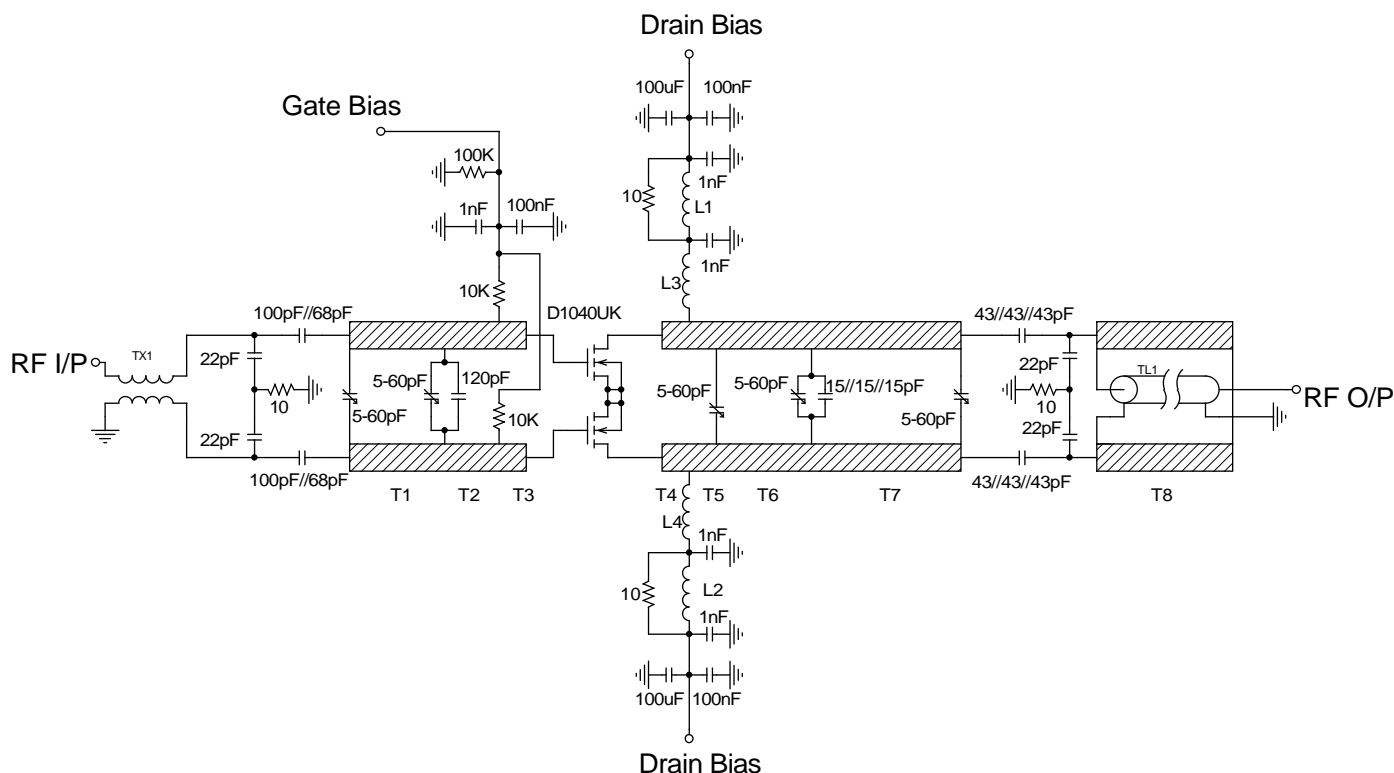

Figure 5 – Typical CV Characteristics.

Semelab Plc reserves the right to change test conditions, parameter limits and package dimensions without notice. Information furnished by Semelab is believed to be both accurate and reliable at the time of going to press. However Semelab assumes no responsibility for any errors or omissions discovered in its use. Semelab encourages customers to verify that datasheets are current before placing orders.



D1040UK 108MHz Test Fixture

Substrate 1.6mm PTFE/glass $\epsilon_r=2.2$

TX1 4 turns 50 Ω coaxial cable wound around toroid

TL1 160mm UT85 semi-rigid coax

L1, L2 1 turn 1.2mm dia wire on Siemens B62152A1X1 2 hole core

L3, L4 4 turns 1.2mm dia wire, 10mm internal dia

T8 4.8mm wide, all other lines 6mm wide

T1 50mm

T2 40mm

T3 10mm

T4 14mm

T5 8mm

T6 40mm

T7 66mm

T8 160mm