

MPSA94U

PNP Silicon Epitaxial Planar Transistor

for high voltage switching and amplifier applications

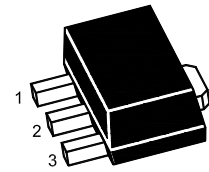

1.Base 2.Collector 3.Emitter
SOT-89 Plastic Package

Absolute Maximum Ratings ($T_a = 25\text{ }^\circ\text{C}$)

Parameter	Symbol	Value	Unit
Collector Base Voltage	$-V_{CBO}$	400	V
Collector Emitter Voltage	$-V_{CEO}$	400	V
Emitter Base Voltage	$-V_{EBO}$	6	V
Collector Current	$-I_C$	300	mA
Total Power Dissipation	P_{tot}	625	mW
Junction Temperature	T_J	150	$^\circ\text{C}$
Storage Temperature Range	T_{stg}	- 55 to + 150	$^\circ\text{C}$

Characteristics at $T_a = 25\text{ }^\circ\text{C}$

Parameter	Symbol	Min.	Max.	Unit
DC Current Gain				
at $-V_{CE} = 10\text{ V}$, $-I_C = 1\text{ mA}$	h_{FE}	70	-	-
at $-V_{CE} = 10\text{ V}$, $-I_C = 10\text{ mA}$	h_{FE}	80	300	-
at $-V_{CE} = 10\text{ V}$, $-I_C = 50\text{ mA}$	h_{FE}	70	-	-
at $-V_{CE} = 10\text{ V}$, $-I_C = 100\text{ mA}$	h_{FE}	60	-	-
Collector Base Cutoff Current at $-V_{CB} = 300\text{ V}$	$-I_{CBO}$	-	0.1	μA
Collector Emitter Cutoff Current at $-V_{CE} = 400\text{ V}$	$-I_{CES}$	-	1	μA
Emitter Base Cutoff Current at $-V_{EB} = 4\text{ V}$	$-I_{EBO}$	-	0.1	μA
Collector Base Breakdown Voltage at $-I_C = 100\text{ }\mu\text{A}$	$-V_{(BR)CBO}$	400	-	V
Collector Emitter Breakdown Voltage at $-I_C = 1\text{ mA}$	$-V_{(BR)CEO}$	400	-	V
Emitter Base Breakdown Voltage at $-I_E = 10\text{ }\mu\text{A}$	$-V_{(BR)EBO}$	6	-	V
Collector Emitter Saturation Voltage at $-I_C = 10\text{ mA}$, $-I_B = 1\text{ mA}$	$-V_{CE(sat)}$	-	0.2	V
at $-I_C = 50\text{ mA}$, $-I_B = 5\text{ mA}$		-	0.5	
Base Emitter Saturation Voltage at $-I_C = 10\text{ mA}$, $-I_B = 1\text{ mA}$	$-V_{BE(sat)}$	-	0.75	V
Collector Output Capacitance at $-V_{CB} = 20\text{ V}$, $f = 1\text{ MHz}$	C_{ob}	-	7	pF

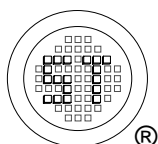

SEMTECH ELECTRONICS LTD.

(Subsidiary of Sino-Tech International Holdings Limited, a company listed on the Hong Kong Stock Exchange, Stock Code: 724)

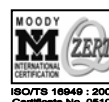

MPSA94U

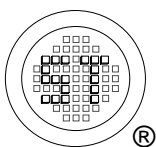
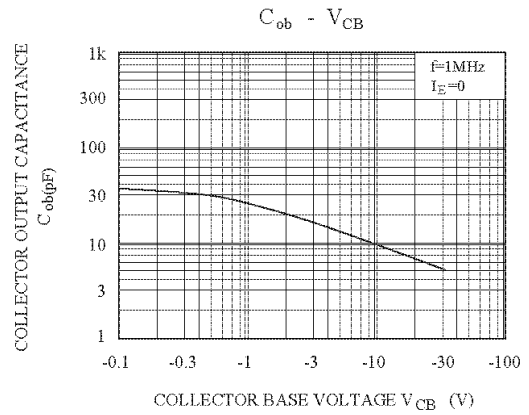
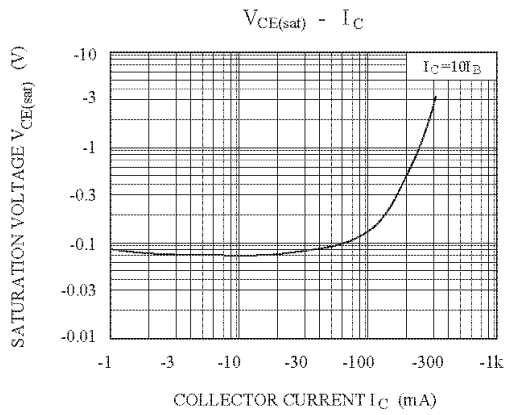
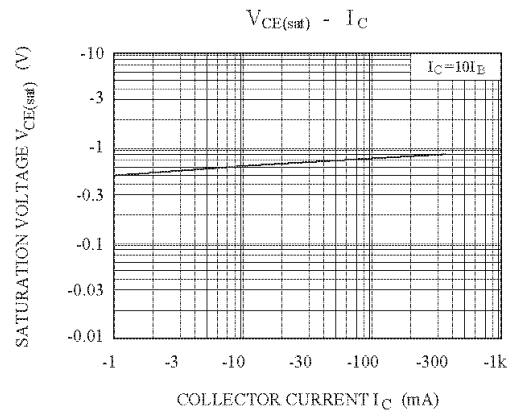
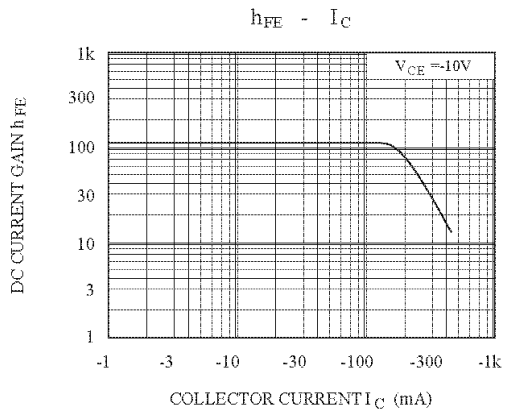

SEMTECH ELECTRONICS LTD.
 (Subsidiary of Sino-Tech International Holdings Limited, a company listed on the Hong Kong Stock Exchange, Stock Code: 724)



MPSA94U

SOT-89 PACKAGE OUTLINE

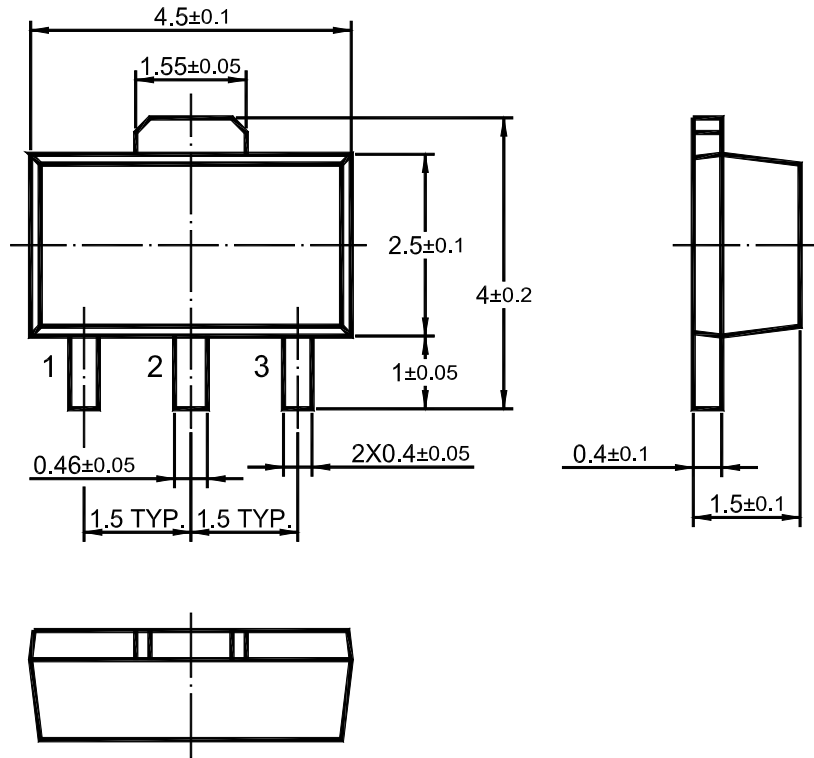

Dimensions in mm

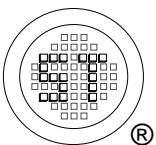

SEMTECH ELECTRONICS LTD.
(Subsidiary of Sino-Tech International Holdings Limited, a company listed on the Hong Kong Stock Exchange, Stock Code: 724)

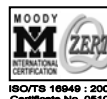

Dated : 12/11/2008