

2SK1151(L)(S), 2SK1152(L)(S)

Silicon N-Channel MOS FET

HITACHI

ADE-208-1245 (Z)

1st. Edition

Mar. 2001

Application

High speed power switching

Features

- Low on-resistance
- High speed switching
- Low drive current
- No secondary breakdown
- Suitable for switching regulator and DC-DC converter

Outline

DPAK-1

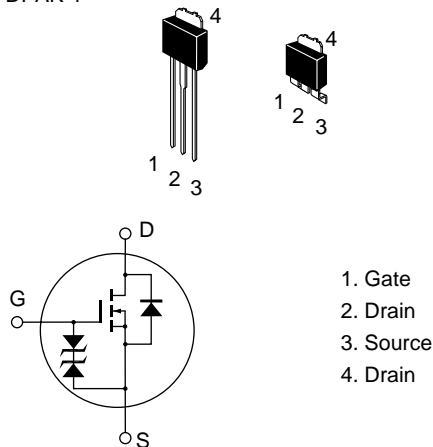

2SK1151(L)(S), 2SK1152(L)(S)

Absolute Maximum Ratings (Ta = 25°C)

Item		Symbol	Ratings	Unit
Drain to source voltage	2SK1151	V_{DSS}	450	V
	2SK1152		500	
Gate to source voltage		V_{GSS}	±30	V
Drain current		I_D	1.5	A
Drain peak current		$I_{D(pulse)}$ ^{*1}	6	A
Body to drain diode reverse drain current		I_{DR}	1.5	A
Channel dissipation		P_{ch} ^{*2}	20	W
Channel temperature		T_{ch}	150	°C
Storage temperature		T_{stg}	-55 to +150	°C

Notes: 1. PW 10 μs, duty cycle 1%

2. Value at $T_c = 25^\circ\text{C}$

Electrical Characteristics (Ta = 25°C)

Item	Symbol	Min	Typ	Max	Unit	Test conditions
Drain to source breakdown voltage	2SK1151 $V_{(BR)DSS}$	450	—	—	V	$I_D = 10 \text{ mA}, V_{GS} = 0$
	2SK1152	500				
Gate to source breakdown voltage	$V_{(BR)GSS}$	±30	—	—	V	$I_G = \pm 100 \text{ } \mu\text{A}, V_{DS} = 0$
Gate to source leak current	I_{GSS}	—	—	±10	μA	$V_{GS} = \pm 25 \text{ V}, V_{DS} = 0$
Zero gate voltage drain current	2SK1151 I_{DSS}	—	—	100	μA	$V_{DS} = 360 \text{ V}, V_{GS} = 0$
	2SK1152					$V_{DS} = 400 \text{ V}, V_{GS} = 0$
Gate to source cutoff voltage	$V_{GS(off)}$	2.0	—	3.0	V	$I_D = 1 \text{ mA}, V_{DS} = 10 \text{ V}$
Static Drain to source on statesesistance	2SK1151 $R_{DS(on)}$	—	3.5	5.5		$I_D = 1 \text{ A}, V_{GS} = 10 \text{ V}^{*1}$
	2SK1152	—	4.0	6.0		
Forward transfer admittance	yfs	0.6	1.1	—	S	$I_D = 1 \text{ A}, V_{DS} = 20 \text{ V}^{*1}$
Input capacitance	Ciss	—	160	—	pF	$V_{DS} = 10 \text{ V}, V_{GS} = 0,$
Output capacitance	Coss	—	45	—	pF	$f = 1 \text{ MHz}$
Reverse transfer capacitance	Crss	—	5	—	pF	
Turn-on delay time	$t_{d(on)}$	—	5	—	ns	$I_D = 1 \text{ A}, V_{GS} = 10 \text{ V},$
Rise time	t_r	—	10	—	ns	$R_L = 30$
Turn-off delay time	$t_{d(off)}$	—	20	—	ns	
Fall time	t_f	—	10	—	ns	
Body to drain diode forward voltage	V_{DF}	—	1.0	—	V	$I_F = 1.5 \text{ A}, V_{GS} = 0$
Body to drain diode reverse recovery time	t_{rr}	—	220	—	ns	$I_F = 1.5 \text{ A}, V_{GS} = 0,$ $di_F/dt = 100 \text{ A}/\mu\text{s}$

Note: 1. Pulse test

2SK1151(L)(S), 2SK1152(L)(S)

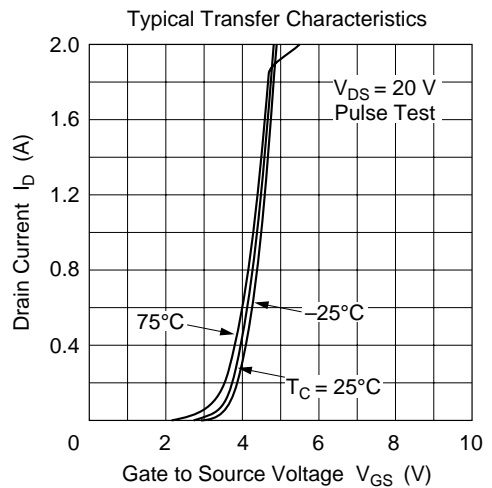
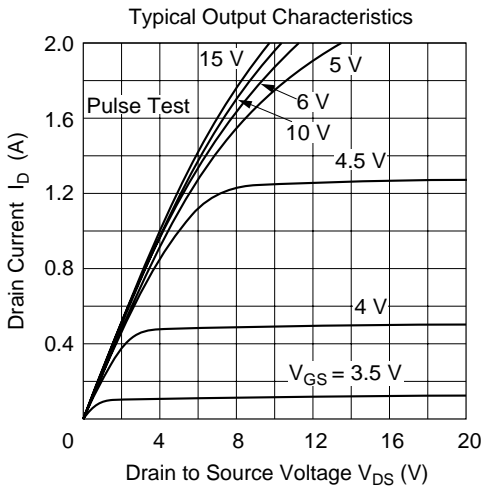
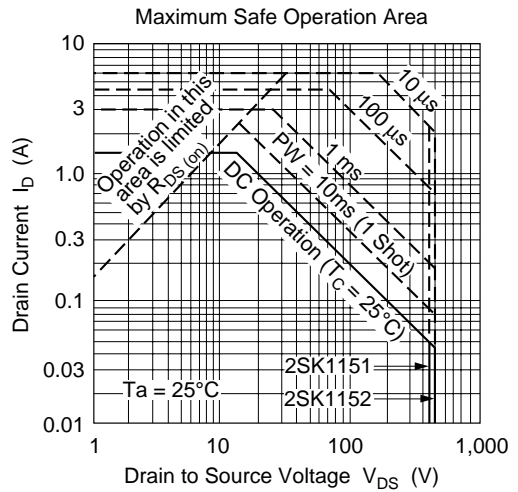
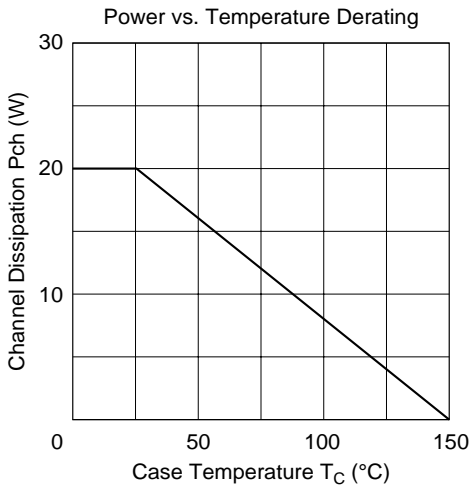

Drain to Source Saturation Voltage vs. Gate to Source Voltage

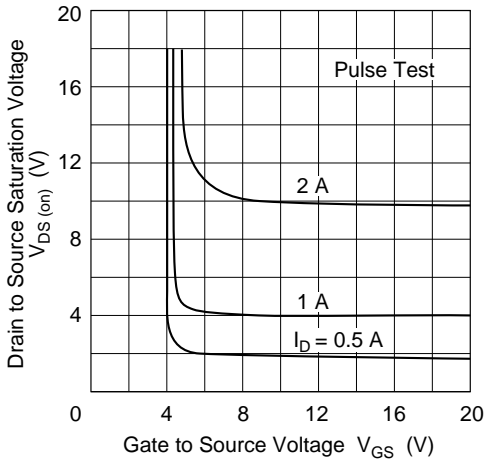

Static Drain to Source on State Resistance vs. Drain Current

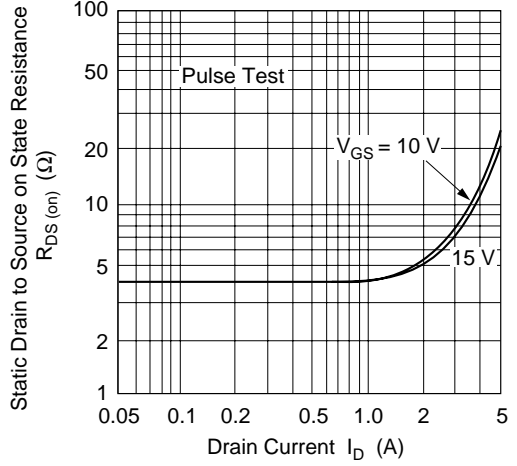

Static Drain to Source on State Resistance vs. Temperature

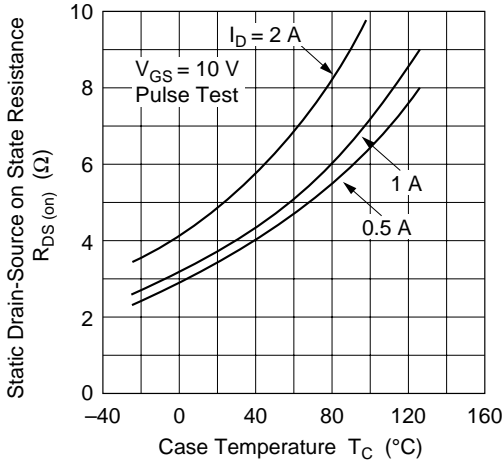

Forward Transfer Admittance vs. Drain Current

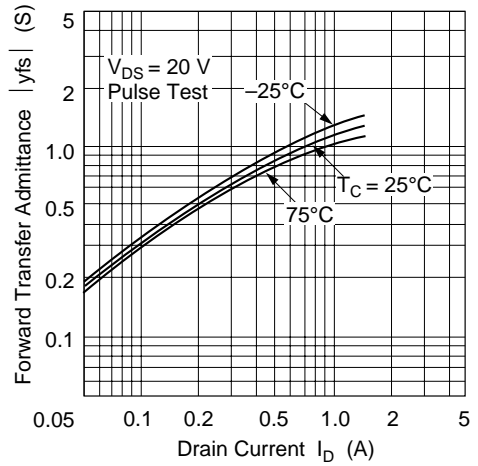

2SK1151(L)(S), 2SK1152(L)(S)

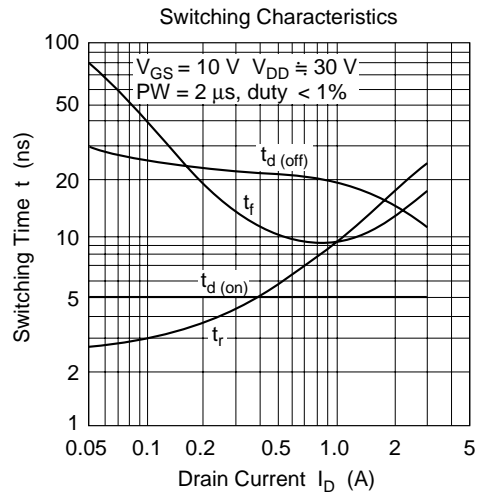
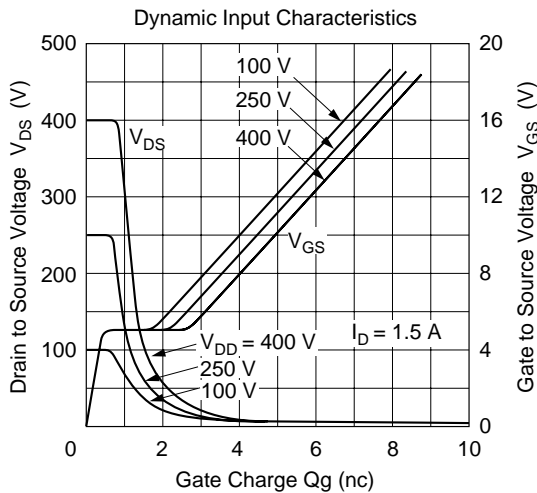
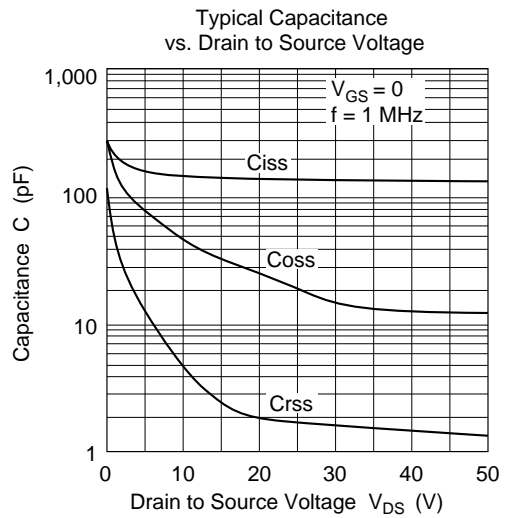
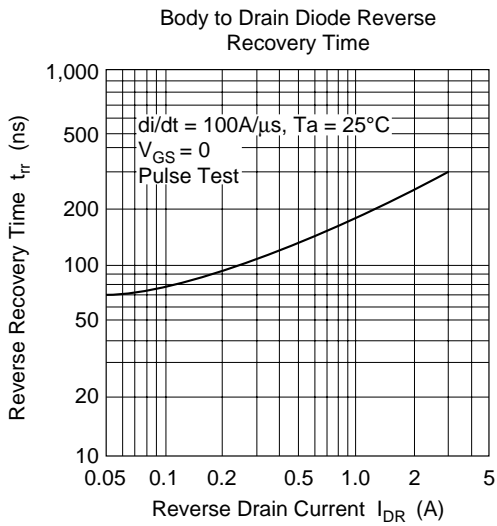

Reverse Drain Current vs. Source to Drain Voltage

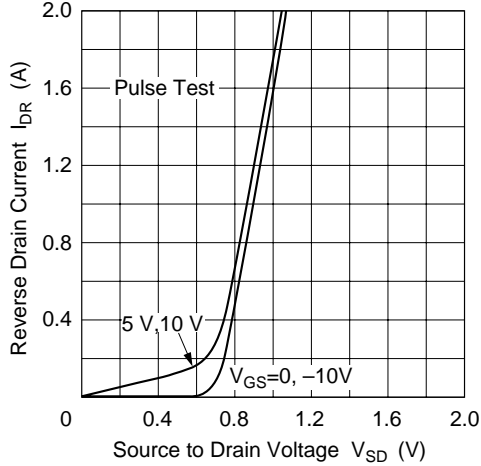

Normalized Transient Thermal Impedance vs. Pulse Width

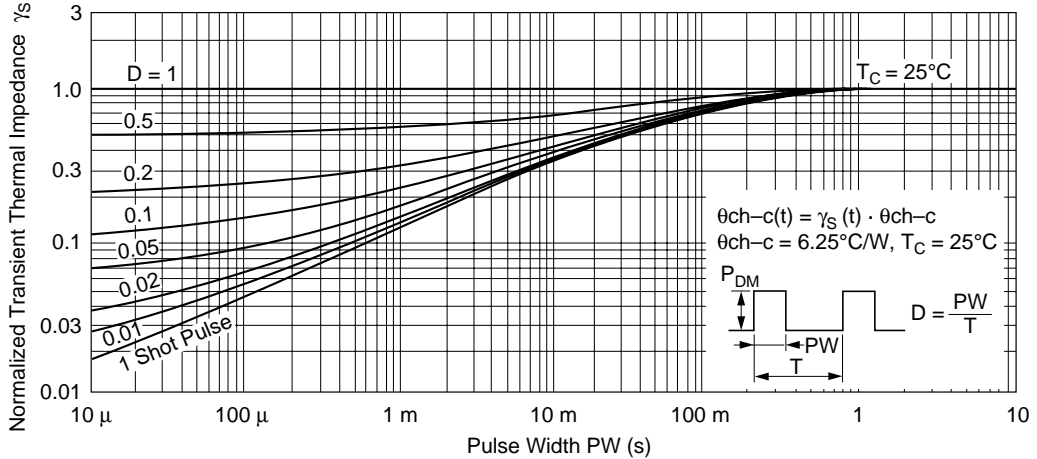

Switching Time Test Circuit

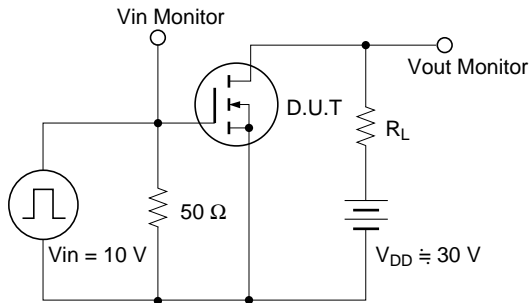

Waveforms

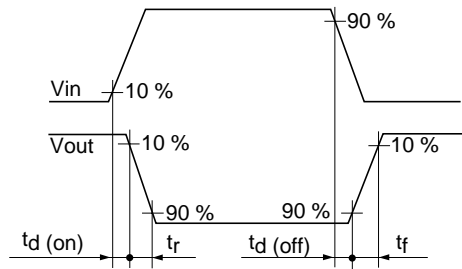

2SK1151(L)(S), 2SK1152(L)(S)

Package Dimensions

As of January, 2001

Unit: mm

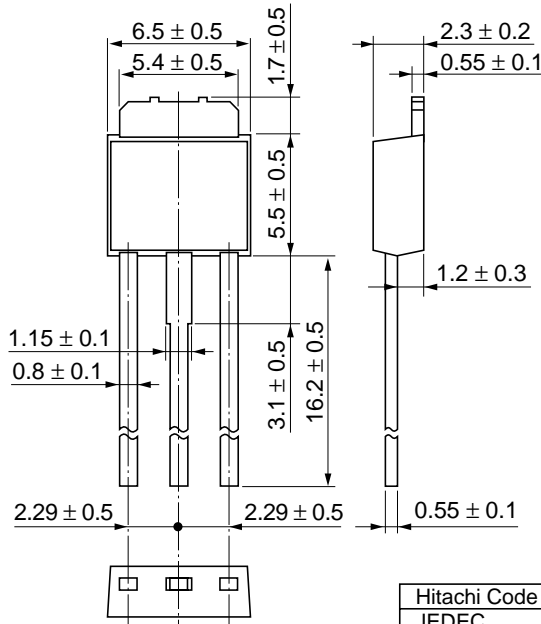

Hitachi Code	DPAK (L)-(1)
JEDEC	—
EIAJ	Conforms
Mass (reference value)	0.42 g

HITACHI

2SK1151(L)(S), 2SK1152(L)(S)

As of January, 2001

Unit: mm

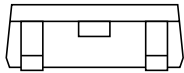
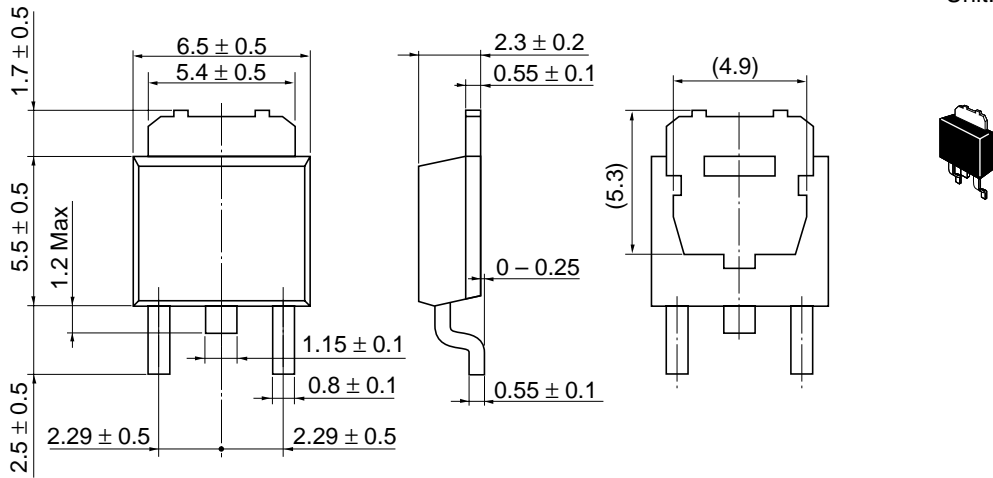

Hitachi Code	DPAK (S)-(1),(2)
JEDEC	—
EIAJ	Conforms
Mass (reference value)	0.28 g

2SK1151(L)(S), 2SK1152(L)(S)

As of January, 2001

Unit: mm

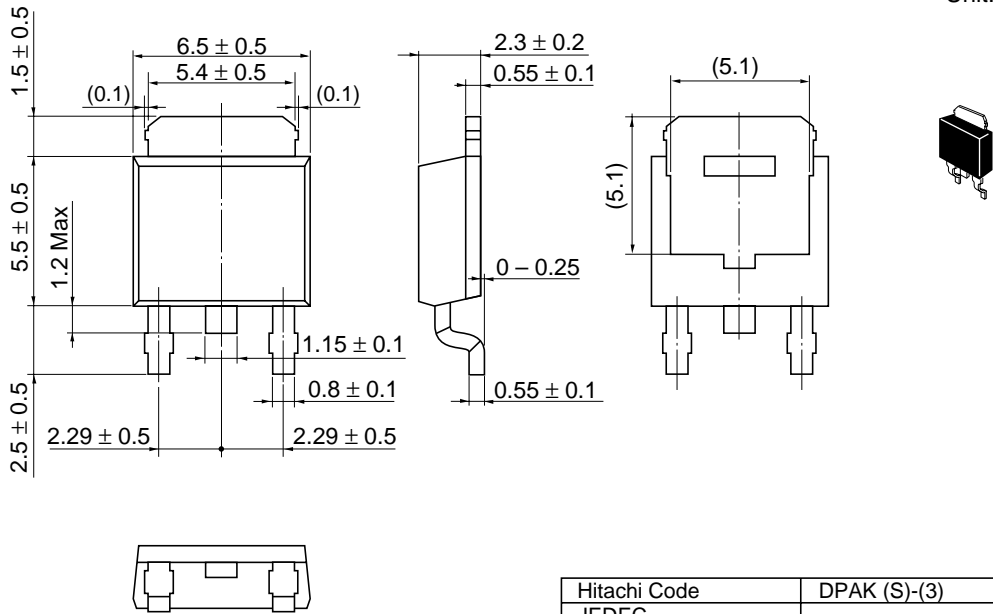

Hitachi Code	DPAK (S)-(3)
JEDEC	—
EIAJ	Conforms
Mass (reference value)	0.28 g

HITACHI

Cautions

1. Hitachi neither warrants nor grants licenses of any rights of Hitachi's or any third party's patent, copyright, trademark, or other intellectual property rights for information contained in this document. Hitachi bears no responsibility for problems that may arise with third party's rights, including intellectual property rights, in connection with use of the information contained in this document.
2. Products and product specifications may be subject to change without notice. Confirm that you have received the latest product standards or specifications before final design, purchase or use.
3. Hitachi makes every attempt to ensure that its products are of high quality and reliability. However, contact Hitachi's sales office before using the product in an application that demands especially high quality and reliability or where its failure or malfunction may directly threaten human life or cause risk of bodily injury, such as aerospace, aeronautics, nuclear power, combustion control, transportation, traffic, safety equipment or medical equipment for life support.
4. Design your application so that the product is used within the ranges guaranteed by Hitachi particularly for maximum rating, operating supply voltage range, heat radiation characteristics, installation conditions and other characteristics. Hitachi bears no responsibility for failure or damage when used beyond the guaranteed ranges. Even within the guaranteed ranges, consider normally foreseeable failure rates or failure modes in semiconductor devices and employ systemic measures such as fail-safes, so that the equipment incorporating Hitachi product does not cause bodily injury, fire or other consequential damage due to operation of the Hitachi product.
5. This product is not designed to be radiation resistant.
6. No one is permitted to reproduce or duplicate, in any form, the whole or part of this document without written approval from Hitachi.
7. Contact Hitachi's sales office for any questions regarding this document or Hitachi semiconductor products.

HITACHI

Hitachi, Ltd.

Semiconductor & Integrated Circuits.
Nippon Bldg., 2-6-2, Ohte-machi, Chiyoda-ku, Tokyo 100-0004, Japan
Tel: Tokyo (03) 3270-2111 Fax: (03) 3270-5109

URL	NorthAmerica	: http://semiconductor.hitachi.com/
	Europe	: http://www.hitachi-eu.com/hel/ecg
	Asia	: http://sicapac.hitachi-asia.com
	Japan	: http://www.hitachi.co.jp/Sicd/indx.htm

For further information write to:

Hitachi Semiconductor
(America) Inc.
179 East Tasman Drive,
San Jose, CA 95134
Tel: <1> (408) 433-1990
Fax: <1> (408) 433-0223

Hitachi Europe GmbH
Electronic Components Group
Dornacher Straße 3
D-85622 Feldkirchen, Munich
Germany
Tel: <49> (89) 9 9180-0
Fax: <49> (89) 9 29 30 00

Hitachi Europe Ltd.
Electronic Components Group.
Whitebrook Park
Lower Cookham Road
Maidenhead
Berkshire SL6 8YA, United Kingdom
Tel: <44> (1628) 585000
Fax: <44> (1628) 585160

Hitachi Asia Ltd.
Hitachi Tower
16 Collyer Quay #20-00,
Singapore 049318
Tel : <65>-538-6533/538-8577
Fax : <65>-538-6933/538-3877
URL : <http://www.hitachi.com.sg>

Hitachi Asia Ltd.
(Taipei Branch Office)
4/F, No. 167, Tun Hwa North Road,
Hung-Kuo Building,
Taipei (105), Taiwan
Tel : <886>-(2)-2718-3666
Fax : <886>-(2)-2718-8180
Telex : 23222 HAS-TP
URL : <http://www.hitachi.com.tw>

Hitachi Asia (Hong Kong) Ltd.
Group III (Electronic Components)
7/F., North Tower,
World Finance Centre,
Harbour City, Canton Road
Tsim Sha Tsui, Kowloon,
Hong Kong
Tel : <852>-(2)-735-9218
Fax : <852>-(2)-730-0281
URL : <http://www.hitachi.com.hk>

Copyright © Hitachi, Ltd., 2000. All rights reserved. Printed in Japan.
Colophon 2.0

HITACHI