

2SC4582
(TP15W45FX)

15A NPN

OUTLINE DIMENSIONS

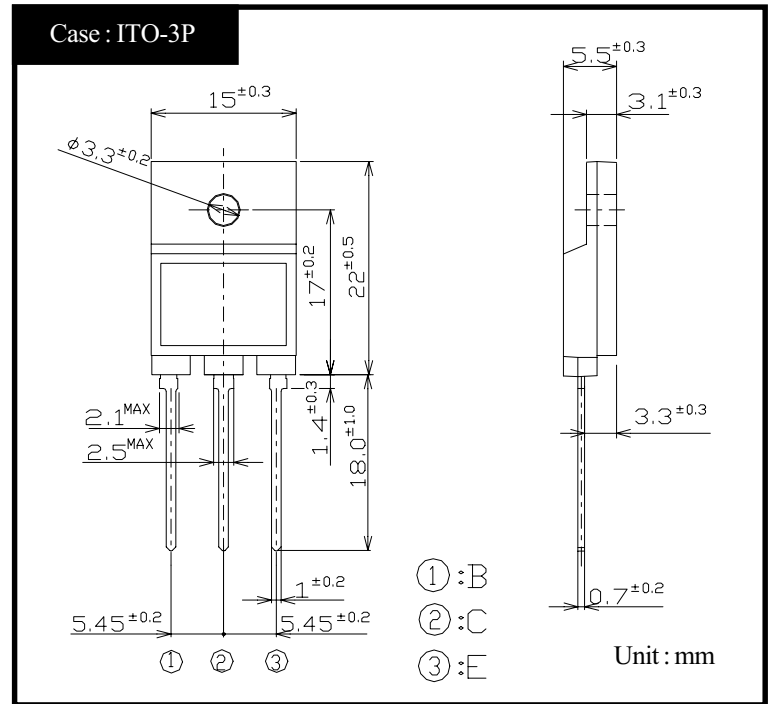

RATINGS

● Absolute Maximum Ratings

Item	Symbol	Conditions	Ratings	Unit
Storage Temperature	T_{stg}		-55~150	°C
Junction Temperature	T_j		150	°C
Collector to Base Voltage	V_{CBO}		600	V
Collector to Emitter Voltage	V_{CEO}		450	V
	V_{CEX}	$V_{EB} = 5V$	600	
Emitter to Base Voltage	V_{EBO}		7	V
Collector Current DC	I_C		15	A
Collector Current Peak	I_{CP}		30	
Base Current DC	I_B		6	A
Base Current Peak	I_{BP}		12	
Total Transistor Dissipation	P_T	$T_C = 25^\circ C$	75	W
Dielectric Strength	V_{dis}	Terminals to case, AC 1 minute	2	kV
Mounting Torque	TOR		0.8	N·m

● Electrical Characteristics ($T_C=25^\circ C$)

Item	Symbol	Conditions	Ratings	Unit
Collector to Emitter Sustaining Voltage	$V_{CEO(sus)}$	$I_C = 0.2A$	Min 450	V
Collector Cutoff Current	I_{CBO}	At rated Voltage	Max 0.1	mA
	I_{CEO}		Max 0.1	
Emitter Cutoff Current	I_{EBO}	At rated Voltage	Max 0.1	mA
DC Current Gain	h_{FE}	$V_{CE} = 5V, I_C = 7.5A$	Min 10	
	h_{FEL}	$V_{CE} = 5V, I_C = 1mA$	Min 5	
Collector to Emitter Saturation Voltage	$V_{CE(sat)}$	$I_C = 7.5A$	Max 1.0	V
Base to Emitter Saturation Voltage	$V_{BE(sat)}$	$I_B = 1.5A$	Max 1.5	V
Thermal Resistance	θ_{jc}	Junction to case	Max 1.67	°C/W
Transition Frequency	f_T	$V_{CE} = 10V, I_C = 1.5A$	STD 20	MHz
Turn on Time	t_{on}	$I_C = 7.5A$	Max 0.5	μs
Storage Time	t_s	$I_{B1} = 1.5A, I_{B2} = 3A$	Max 2.0	
Fall Time	t_f	$R_L = 20\Omega, V_{BB2} = 4V$	Max 0.2	

2SC4582

$h_{FE} - I_C$

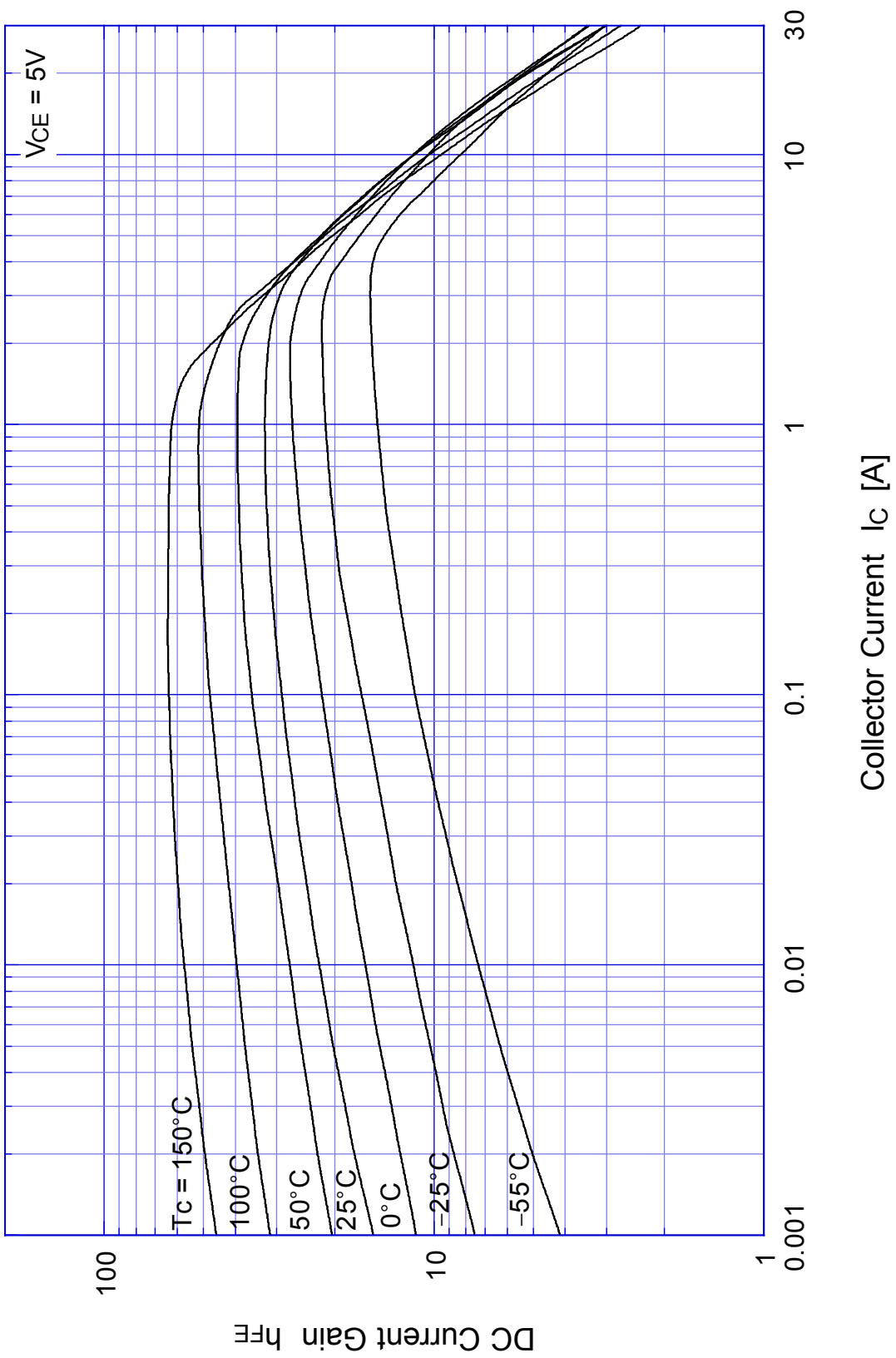

2SC4582 Saturation Voltage

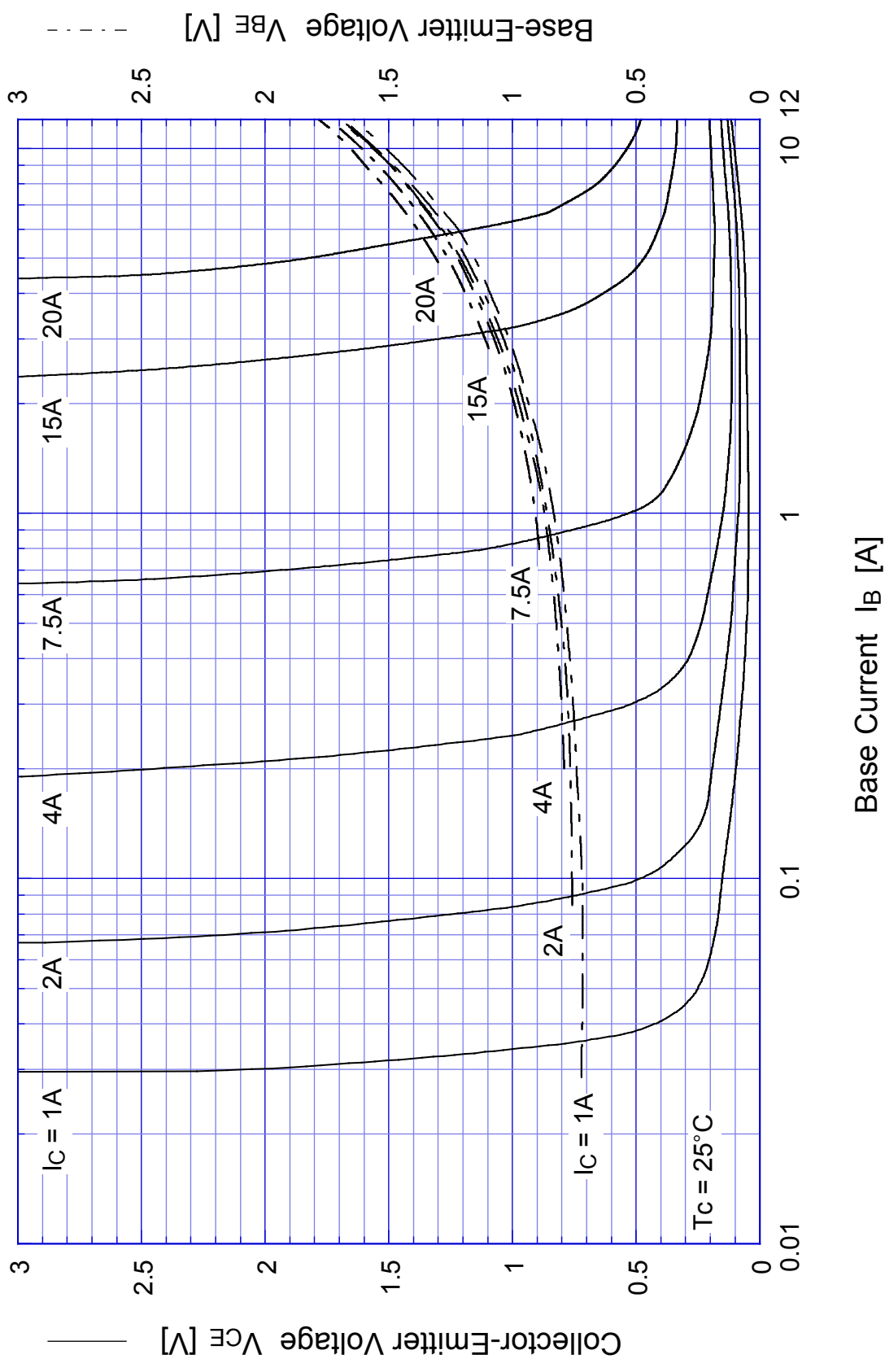

2SC4582

Switching Time - I_C

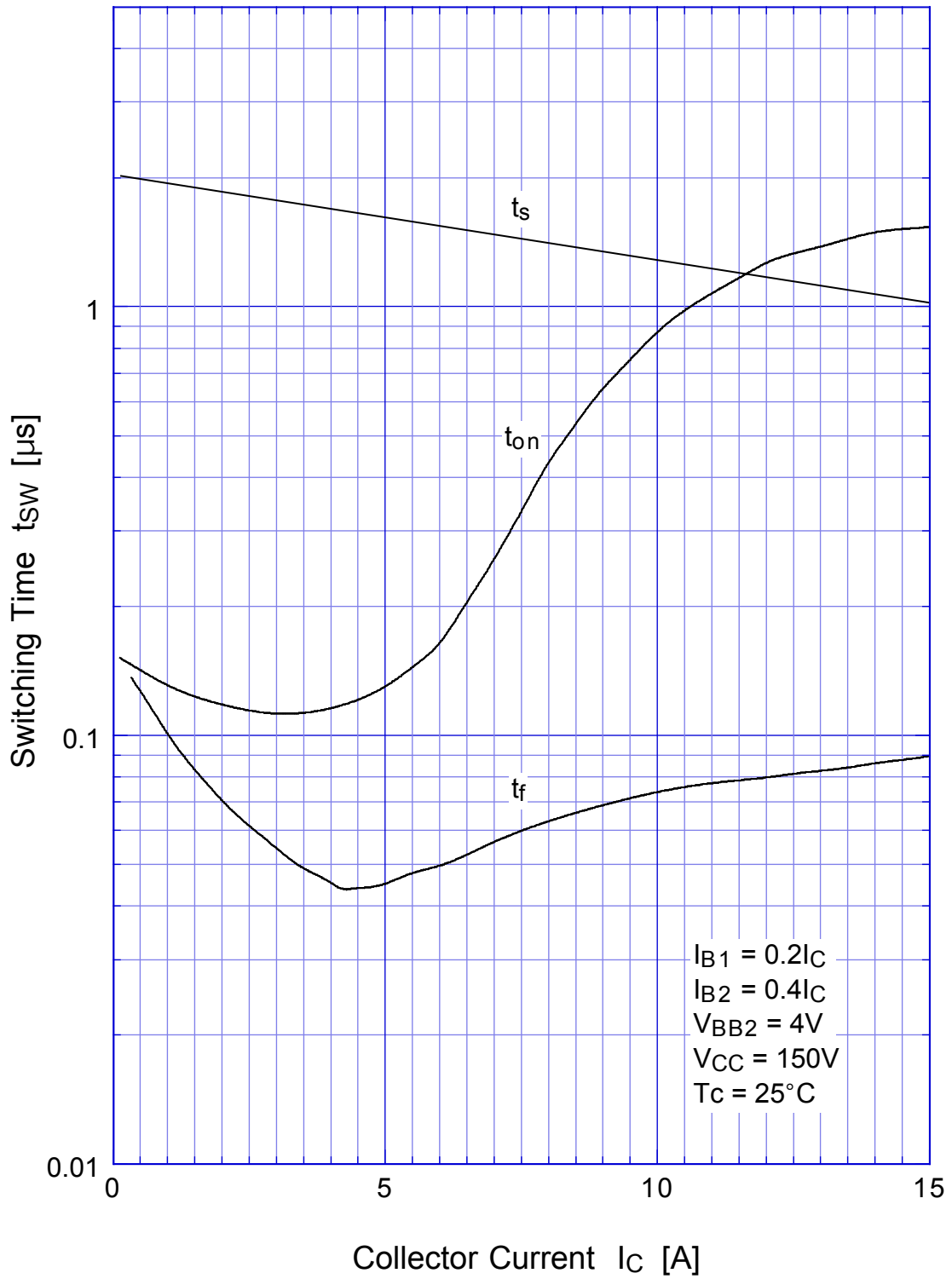

2SC4582 Switching Time - V_{CC}

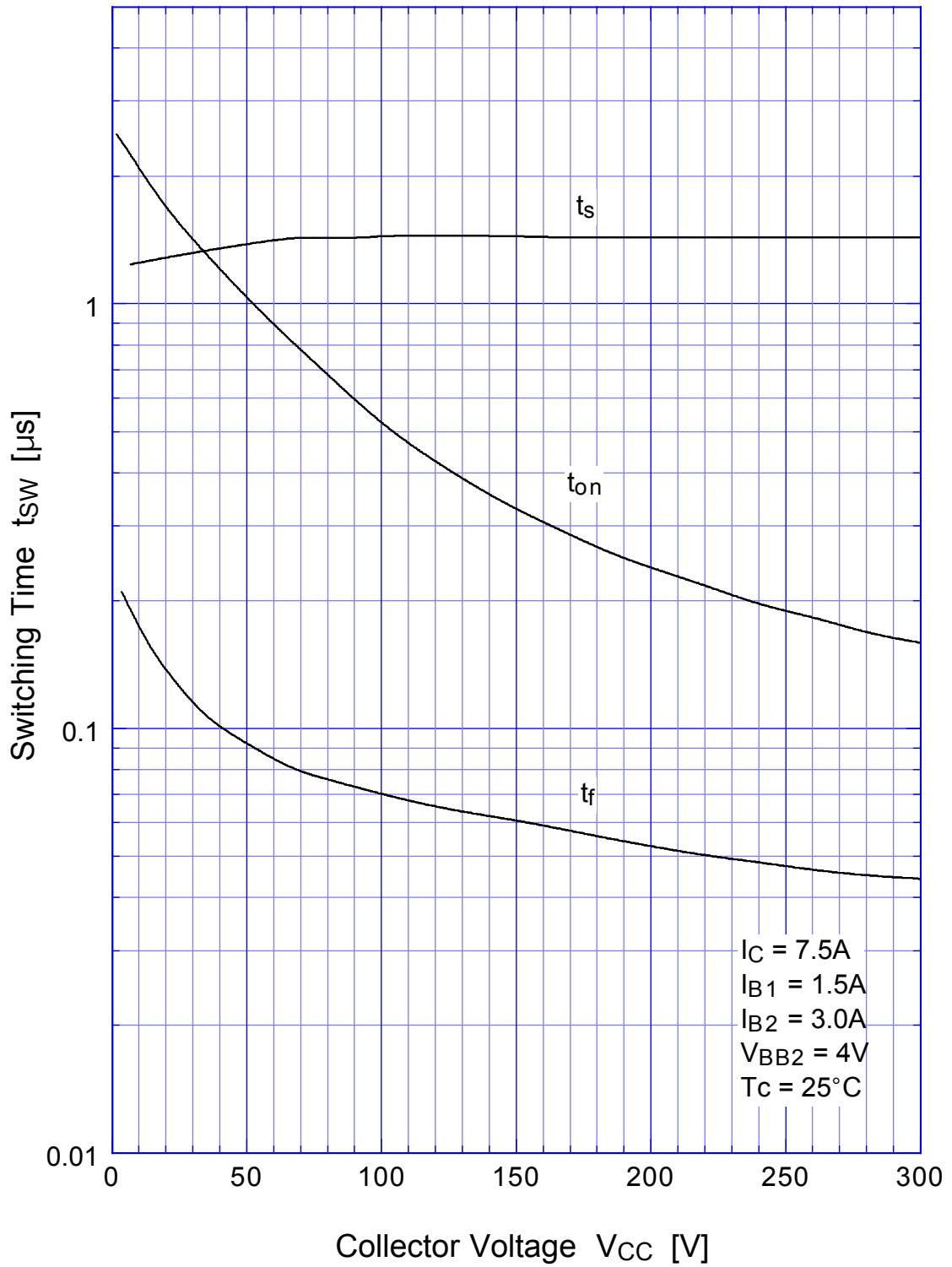

2SC4582

Switching Time - Tc

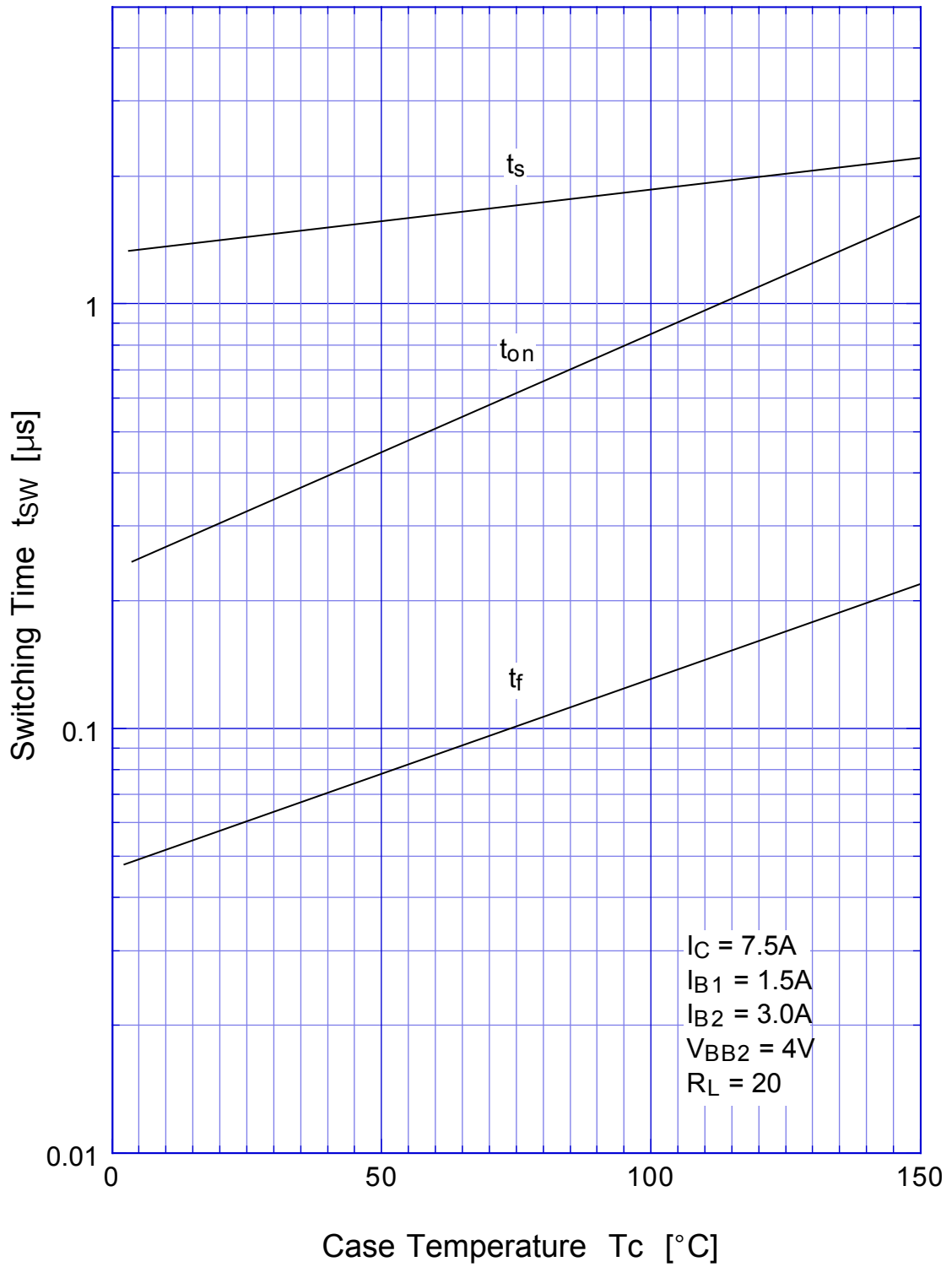

2SC4582 Transient Thermal Impedance

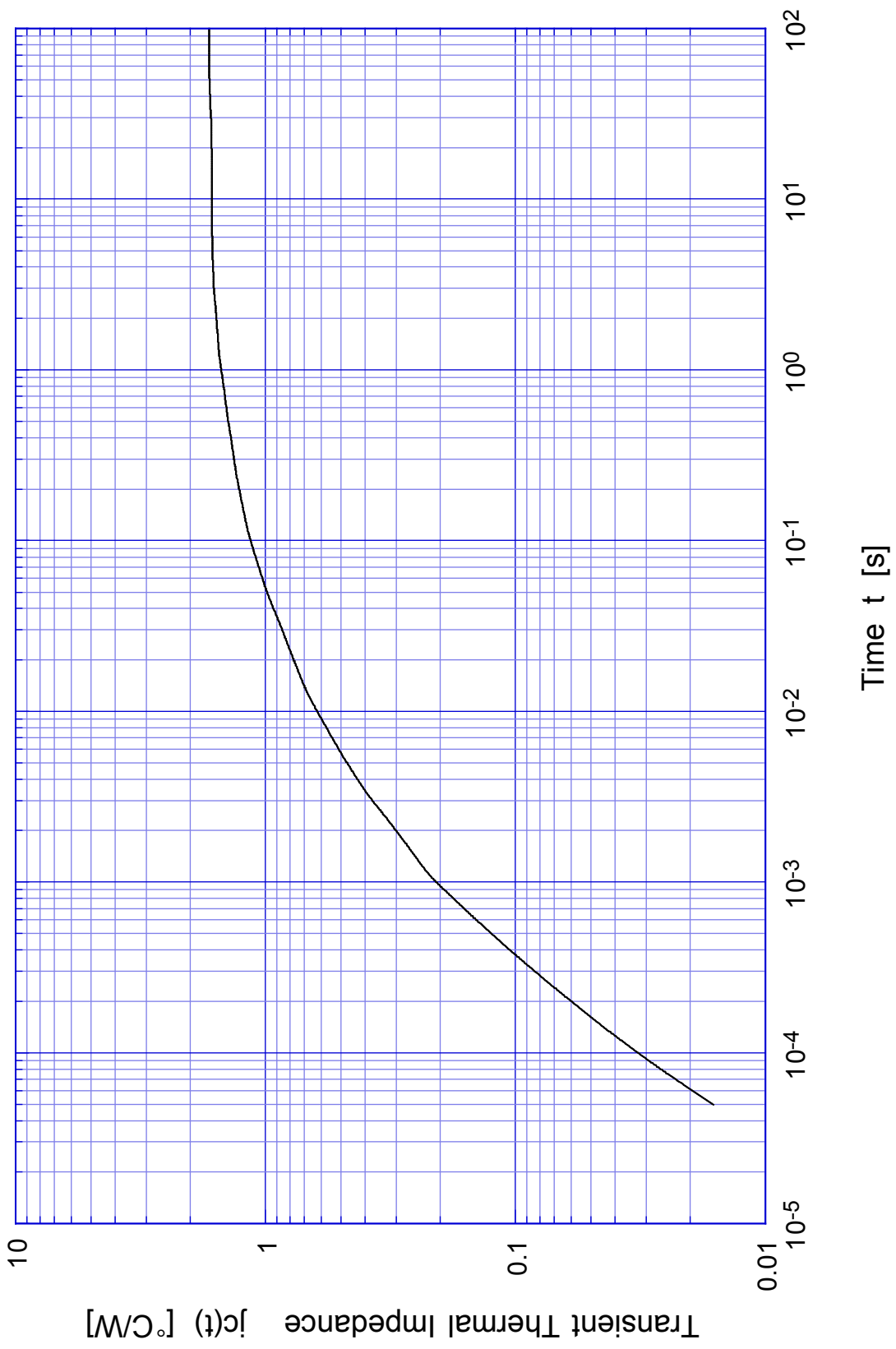

2SC4582

Forward Bias SOA

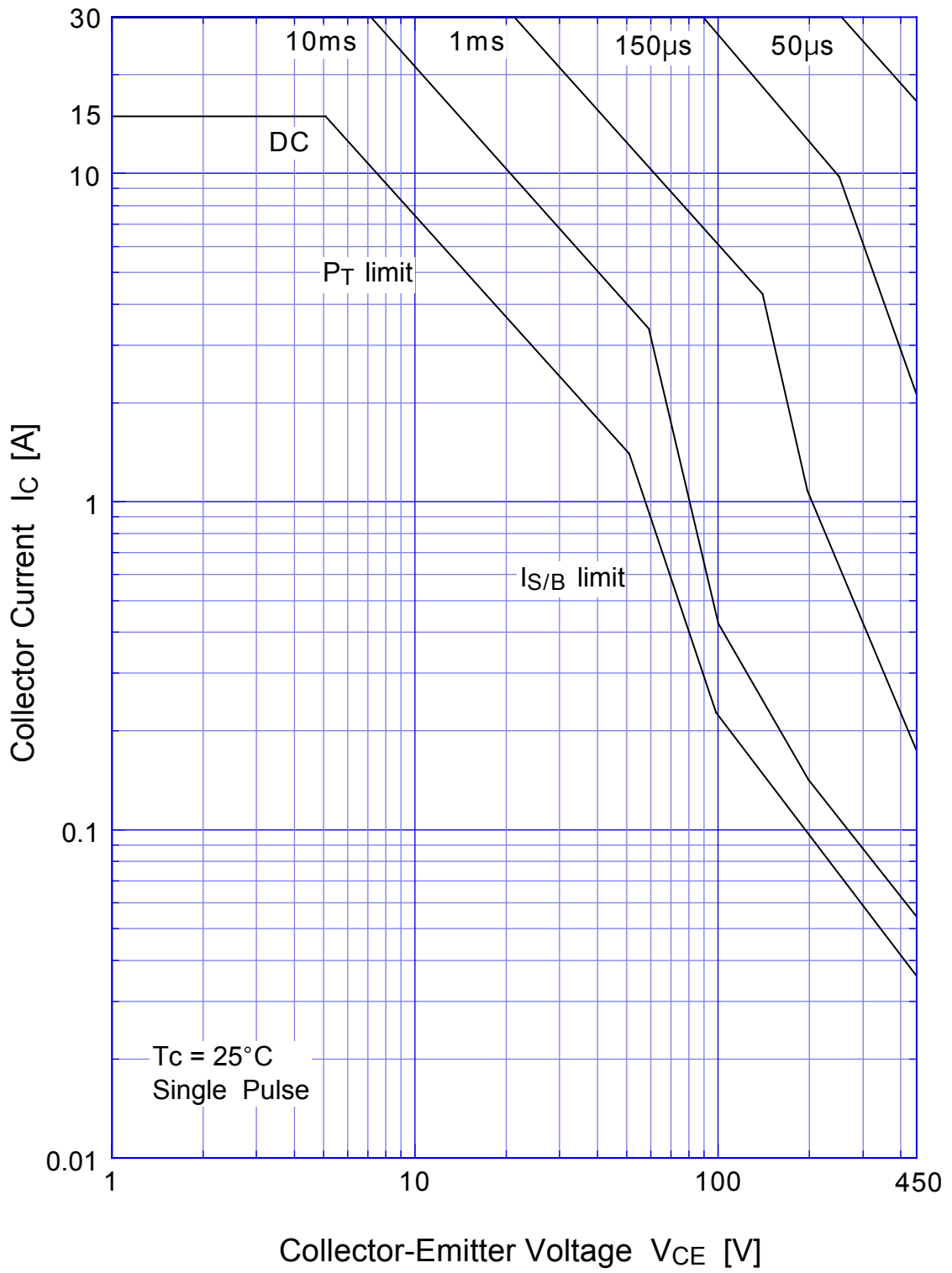

2SC4582 Collector Current Derating

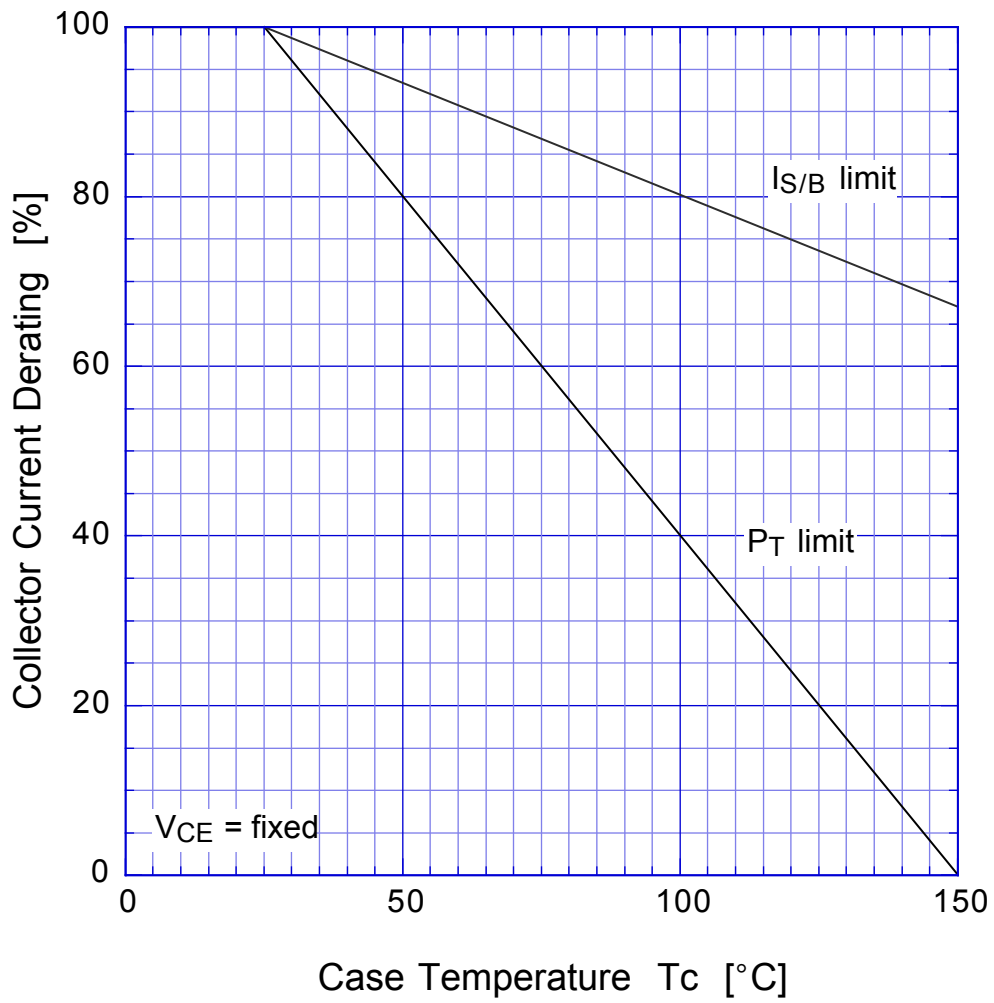

2SC4582

Reverse Bias SOA

