



## FEATURES

- \* Current transfer ratio  
( CTR : MIN. 80% at  $I_F = 5\text{mA}$ ,  $V_{CE} = 5\text{V}$  )
- \* Isolation voltage between input and output LTV-358T  
(  $V_{iso} = 3,750\text{Vrms}$  )
- \* High collector-emitter voltage  
(  $V_{CEO} = 120\text{V}$  )
- \* Employs double transfer mold technology
- \* Subminiature type  
( The volume is smaller than that of conventional DIP type by as far as 30% )
- \* Mini-flat package :  
2.0mm profile : LTV-358T
- \* UL approved ( No. E113898 )
- \* CUL approved ( No. E113898 , 01SC19287 )
- \* CSA approved ( No. 1243207 )
- \* FIMKO approved ( No. FI-16420 )
- \* NEMKO approved ( No. P01100403 )
- \* DEMKO approved ( No. 310475-01 )
- \* SEMKO approved ( No. 0109173 / 01-08 )
- \* VDE approved ( No. 094722 )

## APPLICATIONS

- \* Hybrid substrates that require high density mounting.
- \* Programmable controllers

**OUTLINE DIMENSIONS**

**LTV-358T :**

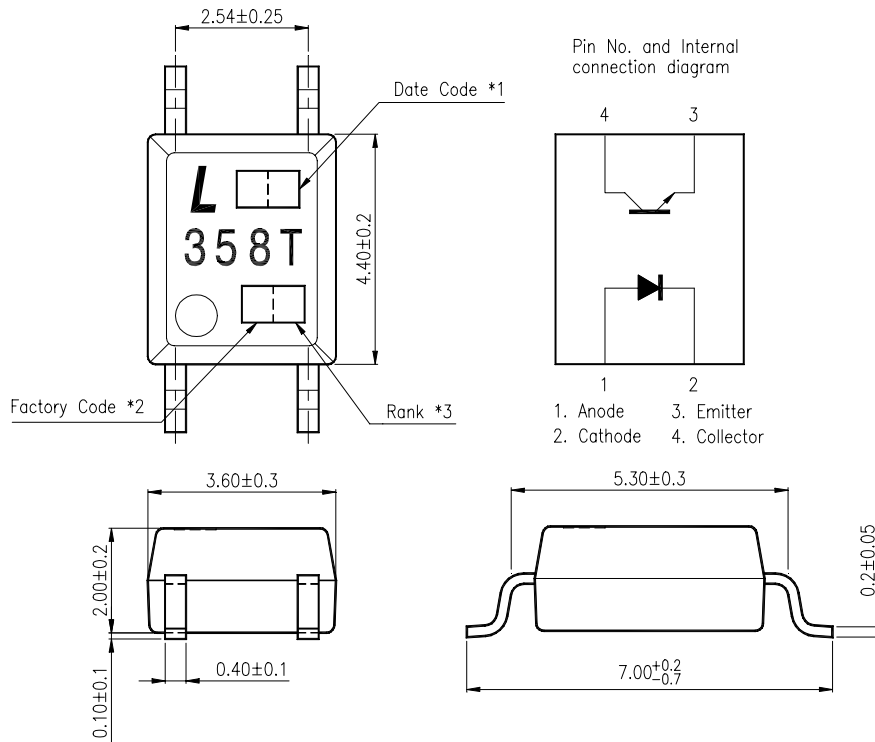

- \*1. 2-digit date code.
- \*2. Factory identification mark shall be marked (Z : Taiwan, Y : Thailand, X : China).
- \*3. Rank shall be or shall not be marked.

**TAPING DIMENSIONS**

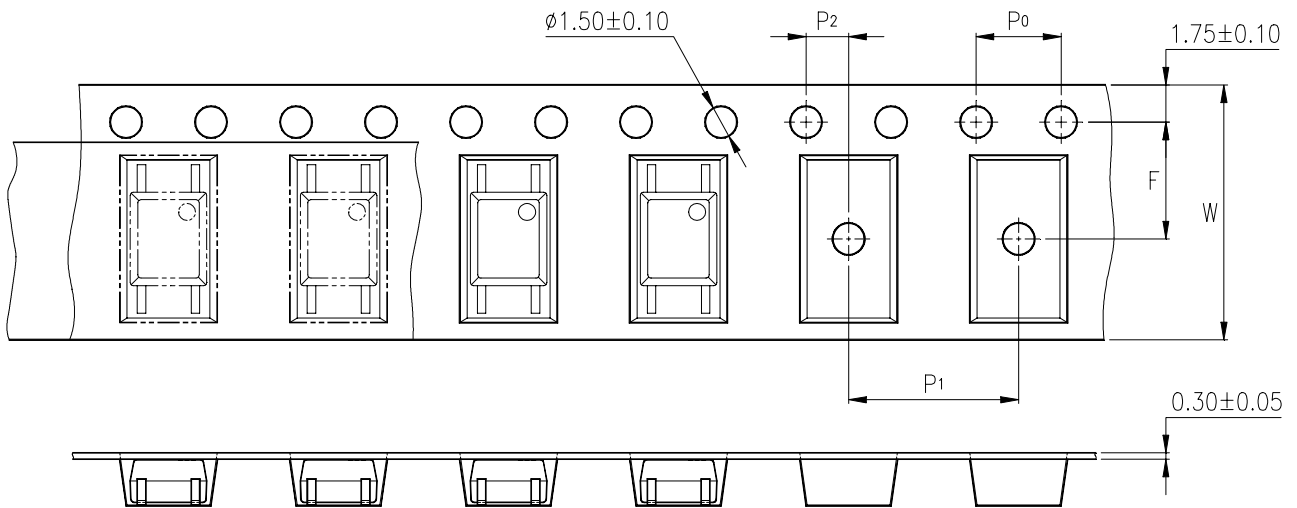

Description	Symbol	Dimensions in mm ( inches )
Tape wide	W	12 ± 0.3 ( .47 )
Pitch of sprocket holes	P <sub>0</sub>	4 ± 0.1 ( .15 )
Distance of compartment	F	5.5 ± 0.1 ( .217 )
	P <sub>2</sub>	2 ± 0.1 ( .079 )
Distance of compartment to compartment	P <sub>1</sub>	8 ± 0.1 ( .315 )

**ABSOLUTE MAXIMUM RATING**

( Ta = 25°C )

PARAMETER		SYMBOL	RATING	UNIT
INPUT	Forward Current	I <sub>F</sub>	50	mA
	Reverse Voltage	V <sub>R</sub>	6	V
	Power Dissipation	P	70	mW
OUTPUT	Collector - Emitter Voltage	V <sub>CEO</sub>	120	V
	Emitter - Collector Voltage	V <sub>ECO</sub>	6	V
	Collector Current	I <sub>C</sub>	50	mA
	Collector Power Dissipation	P <sub>C</sub>	150	mW
Total Power Dissipation		P <sub>tot</sub>	170	mW
*1	Isolation Voltage	V <sub>iso</sub>	3,750	V <sub>rms</sub>
Operating Temperature		T <sub>opr</sub>	-55 ~ +100	°C
Storage Temperature		T <sub>stg</sub>	-55 ~ +150	°C
*2	Soldering Temperature	T <sub>sol</sub>	260	°C

\*1. AC For 1 Minute, R.H. = 40 ~ 60%

Isolation voltage shall be measured using the following method.

- (1) Short between anode and cathode on the primary side and between collector and emitter on the secondary side.
- (2) The isolation voltage tester with zero-cross circuit shall be used.
- (3) The waveform of applied voltage shall be a sine wave.

\*2. For 10 Seconds

## ELECTRICAL - OPTICAL CHARACTERISTICS

( Ta = 25°C )

PARAMETER		SYMBOL	MIN.	TYP.	MAX.	UNIT	CONDITIONS
INPUT	Forward Voltage	V <sub>F</sub>	—	1.2	1.4	V	I <sub>F</sub> =20mA
	Reverse Current	I <sub>R</sub>	—	—	10	μA	V <sub>R</sub> =4V
	Terminal Capacitance	C <sub>t</sub>	—	30	250	pF	V=0, f=1KHz
OUTPUT	Collector Dark Current	I <sub>CEO</sub>	—	—	100	nA	V <sub>CE</sub> =40V, I <sub>F</sub> =0
	Collector-Emitter Breakdown Voltage	BV <sub>CEO</sub>	120	—	—	V	I <sub>C</sub> =0.1mA I <sub>F</sub> =0
	Emitter-Collector Breakdown Voltage	BV <sub>ECO</sub>	6	—	—	V	I <sub>E</sub> =10μA I <sub>F</sub> =0
TRANSFER CHARACTERISTICS	Collector Current	I <sub>C</sub>	4	—	20	mA	I <sub>F</sub> =5mA
	*1 Current Transfer Ratio	CTR	80	—	400	%	V <sub>CE</sub> =5V
	Collector Current	I <sub>C</sub>	0.2	—	—	mA	I <sub>F</sub> =1mA
	*1 Current Transfer Ratio	CTR	20	—	—	%	V <sub>CE</sub> =5V
	Collector-Emitter Saturation Voltage	V <sub>CE(sat)</sub>	—	—	0.2	V	I <sub>F</sub> =20mA I <sub>C</sub> =1mA
	Isolation Resistance	R <sub>iso</sub>	5×10 <sup>10</sup>	1×10 <sup>11</sup>	—	Ω	DC500V 40 ~ 60% R.H.
	Floating Capacitance	C <sub>f</sub>	—	0.6	1	pF	V=0, f=1MHz
	Response Time (Rise)	t <sub>r</sub>	—	4	18	μs	V <sub>CE</sub> =2V, I <sub>C</sub> =2mA R <sub>L</sub> =100Ω
	Response Time (Fall)	t <sub>f</sub>	—	3	18	μs	

$$*1 \text{ CTR} = \frac{I_C}{I_F} \times 100\%$$

**RANK TABLE OF CURRENT TRANSFER RATIO CTR**

<b>MODEL NO.</b>	<b>RANK MARK</b>	<b>CTR (%)</b>	<b>CTR (%)</b>
LTV-358T	A	80 ~ 160	>20
	B	130 ~ 260	>45
	C	200 ~ 400	>70
	A or B or C or No Rank	80 ~ 400	>20

<b>CONDITIONS</b>	$I_F = 5 \text{ mA}$ $V_{CE} = 5 \text{ V}$ $T_a = 25 \text{ }^\circ\text{C}$	$I_F = 1 \text{ mA}$ $V_{CE} = 5 \text{ V}$ $T_a = 25 \text{ }^\circ\text{C}$
-------------------	---	---

**CHARACTERISTICS CURVES**

Fig.1 Forward Current vs. Ambient Temperature

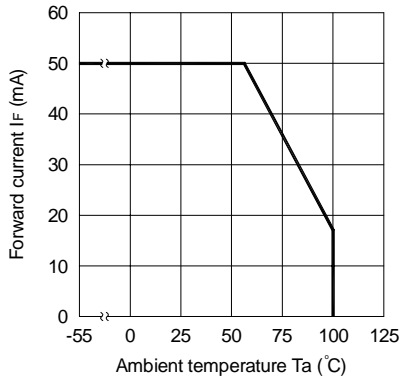

Fig.2 Collector Power Dissipation vs. Ambient Temperature

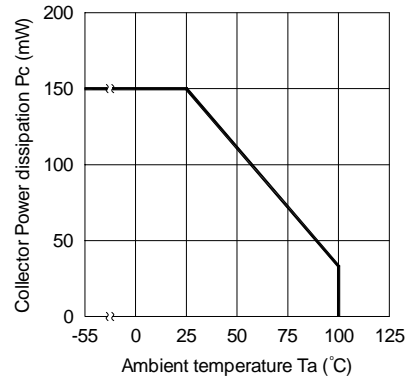

Fig.3 Collector-emitter Saturation Voltage vs. Forward Current

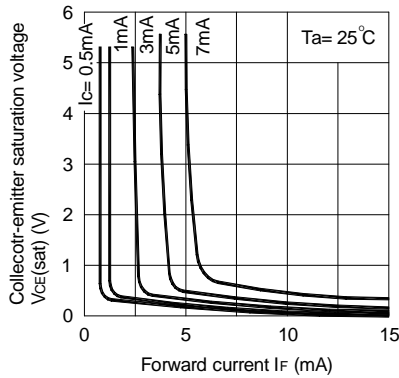

Fig.4 Forward Current vs. Forward Voltage

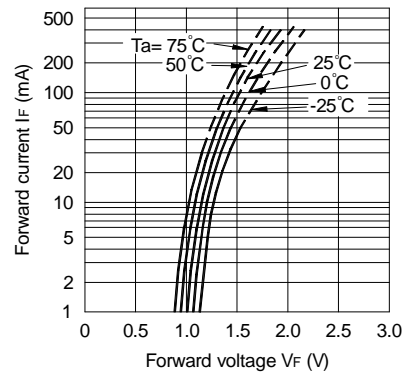

Fig.5 Current Transfer Ratio vs. Forward Current

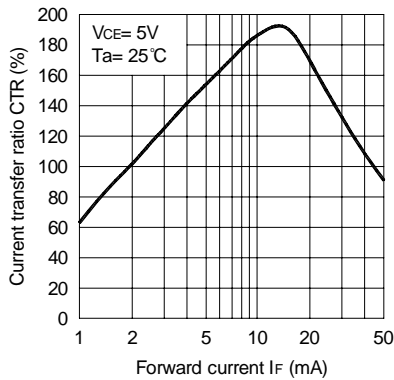
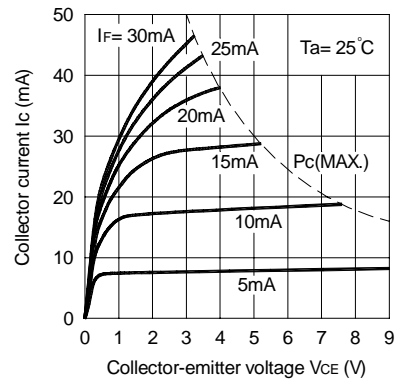

Fig.6 Collector Current vs. Collector-emitter Voltage



## CHARACTERISTICS CURVES

Fig.7 Relative Current Transfer Ratio vs. Ambient Temperature

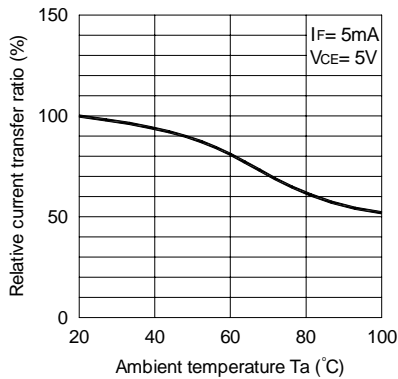

Fig.8 Collector-emitter Saturation Voltage vs. Ambient Temperature

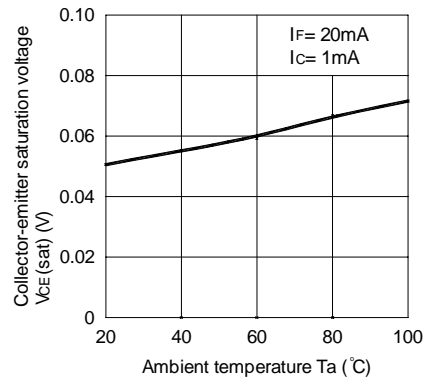

Fig.9 Collector Dark Current vs. Ambient Temperature

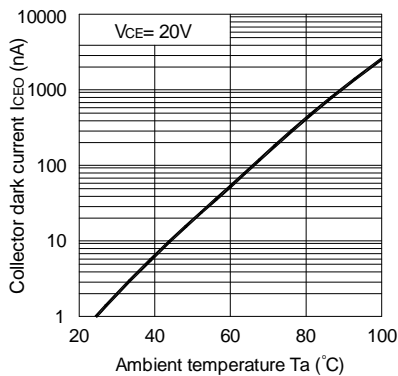

Fig.10 Response Time vs. Load Resistance

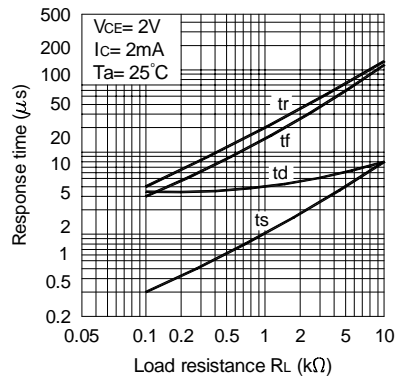
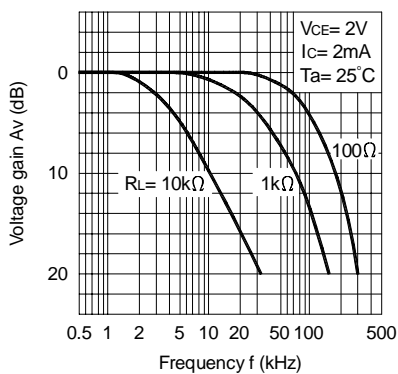
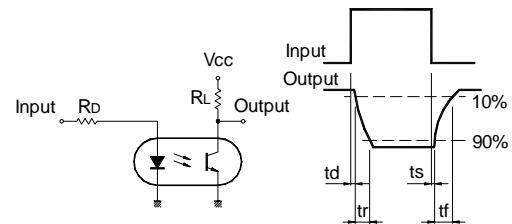

Fig.11 Frequency Response



Test Circuit for Response Time



Test Circuit for Frequency Response

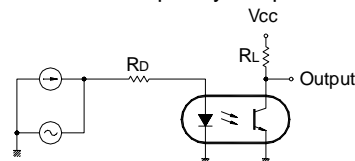



## Temperature Profile of Soldering Reflow

(1) One time soldering reflow is recommended within the condition of temperature and time profile shown below.

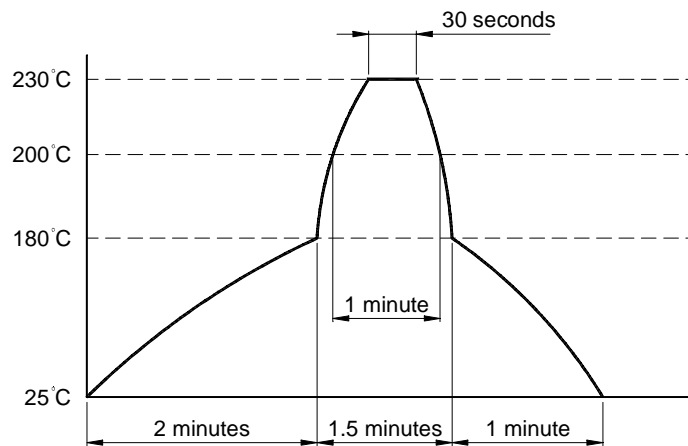

(2) When using another soldering method such as infrared ray lamp, the temperature may rise partially in the mold of the device.

Keep the temperature on the package of the device within the condition of above (1)

## RECOMMENDED FOOT PRINT PATTERNS (MOUNT PAD)

Unit : mm

