



P0130AA

SENSITIVE

0.8A SCRs

MAIN FEATURES:

Symbol	Value	Unit
$I_{T(RMS)}$	0.8	A
V_{DRM}/V_{RRM}	100	V
I_{GT}	1	μA

DESCRIPTION

The P0130AA is a gate sensitive SCR, packaged in TO-92, used in conjunction of a TN22 A.S.D™ and of a resistor in electronic starter for fluorescent tubelamps.

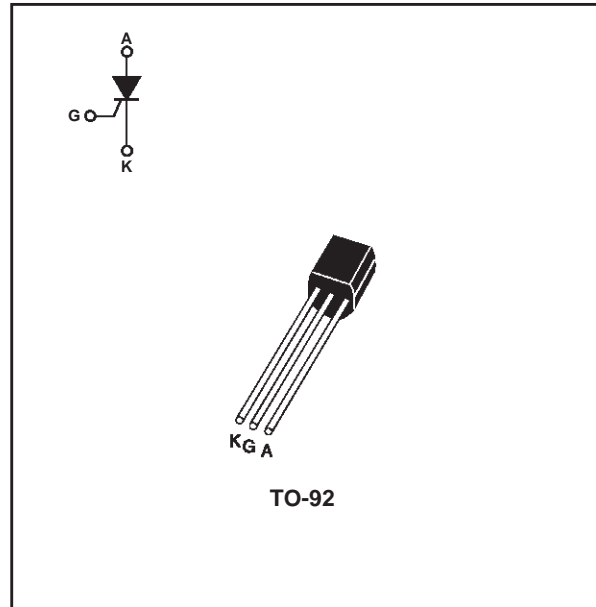

ABSOLUTE RATINGS (limiting values)

Symbol	Parameter		Value	Unit	
$I_{T(RMS)}$	RMS on-state current (180° conduction angle)		$T_I = 55^\circ C$ 0.8	A	
$I_{T(AV)}$	Average on-state current (180° conduction angle)		$T_I = 55^\circ C$ 0.5	A	
I_{TSM}	Non repetitive surge peak on-state current	$t_p = 8.3 \text{ ms}$	$T_j = 25^\circ C$	8	A
		$t_p = 10 \text{ ms}$		7	
I_t	I_t Value for fusing	$t_p = 10 \text{ ms}$	$T_j = 25^\circ C$	0.24	A^2s
di/dt	Critical rate of rise of on-state current $I_G = 2 \times I_{GT}$, $t_r \leq 100 \text{ ns}$	$F = 60 \text{ Hz}$	$T_j = 125^\circ C$	50	$A/\mu s$
I_{GM}	Peak gate current	$t_p = 20 \mu s$	$T_j = 125^\circ C$	1	A
$P_{G(AV)}$	Average gate power dissipation		$T_j = 125^\circ C$	0.1	W
T_{stg} T_j	Storage junction temperature range Operating junction temperature range			- 40 to + 150 - 40 to + 125	$^\circ C$

P0130AA

ELECTRICAL CHARACTERISTICS (T_j = 25°C, unless otherwise specified)

Symbol	Test Conditions		P0130AA	Unit	
I _{GT}	V _D = 12 V R _L = 140 Ω	MIN.	0.1	μA	
		MAX.	1		
V _{GT}		MAX.	0.8	V	
V _{GD}	V _D = V _{DRM} R _L = 3.3 kΩ R _{GK} = 1 kΩ	T _j = 125°C	MIN.	0.1	V
V _{RG}	I _{RG} = 10 μA		MIN.	8	V
I _H	I _T = 50 mA R _{GK} = 1 kΩ		MAX.	5	mA
I _L	I _G = 1 mA R _{GK} = 1 kΩ		MAX.	6	mA
dV/dt	V _D = 67 % V _{DRM} R _{GK} = 1 kΩ	T _j = 125°C	MIN.	25	V/μs
V _{TM}	I _{TM} = 1.6 A t _p = 380 μs	T _j = 25°C	MAX.	1.95	V
V _{t0}	Threshold voltage	T _j = 125°C	MAX.	0.95	V
R _d	Dynamic resistance	T _j = 125°C	MAX.	600	mΩ
I _{DRM} I _{RRM}	V _{DRM} = V _{RDM} R _{GK} = 1 kΩ	T _j = 25°C	MAX.	1	μA
		T _j = 125°C	MAX.	100	

THERMAL RESISTANCES

Symbol	Parameter	Value	Unit
R _{th(j-i)}	Junction to case (DC)	80	°C/W
R _{th(j-a)}	Junction to ambient (DC)	150	°C/W

PRODUCT SELECTOR

Part Number	Voltage	Sensitivity	Package
P0130AA	100V	1 μA	TO-92

ORDERING INFORMATION

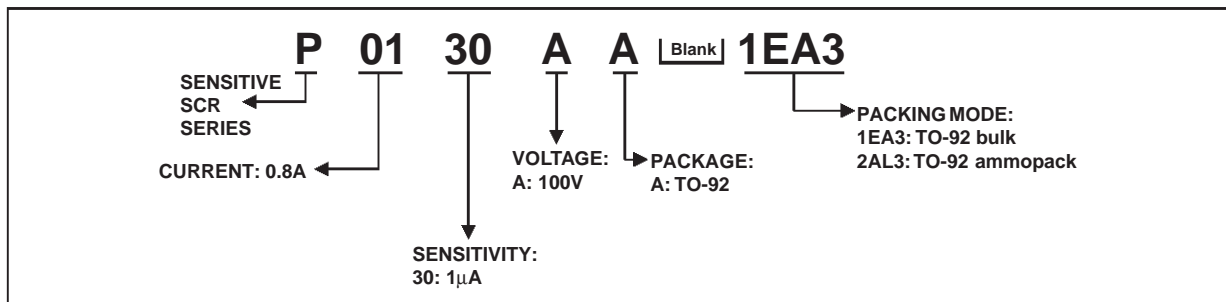

OTHER INFORMATION

Part Number	Marking	Weight	Base Quantity	Packing mode
P0130AA 1EA3	P0130AA	0.2 g	2500	Bulk
P0130AA 2AL3	P0130AA	0.2 g	2000	Ampack

Note: xx = sensitivity, y = voltage

Fig. 1: Maximum average power dissipation versus average on-state current.

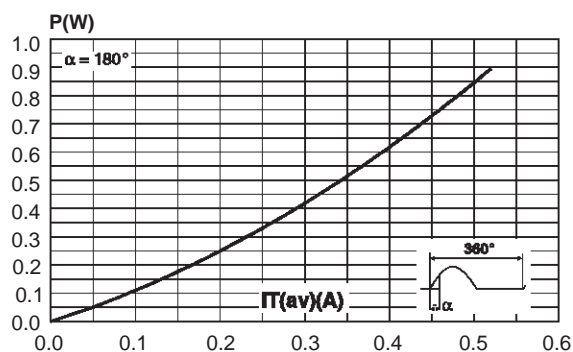

Fig. 2-2: Average and D.C. on-state current versus ambient temperature.

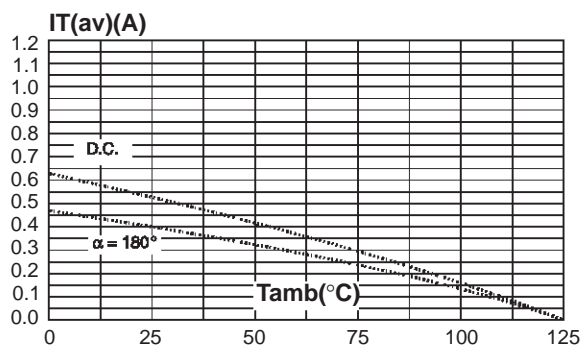

Fig. 2-1: Average and D.C. on-state current versus lead temperature.

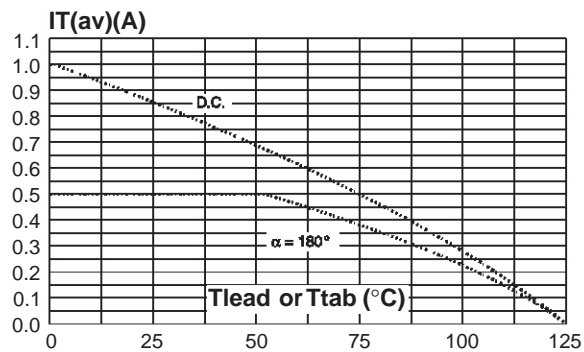

Fig. 3: Relative variation of thermal impedance junction to ambient versus pulse duration.

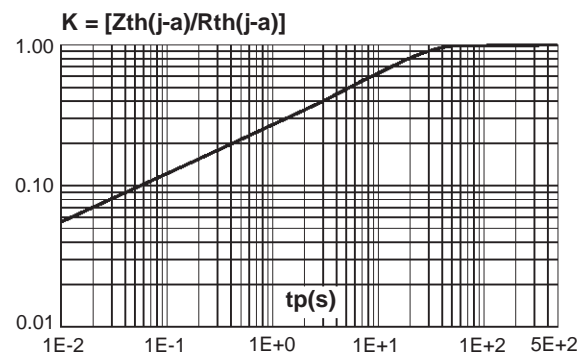

Fig. 4: Relative variation of gate trigger current, holding current and latching current versus junction temperature (typical values).

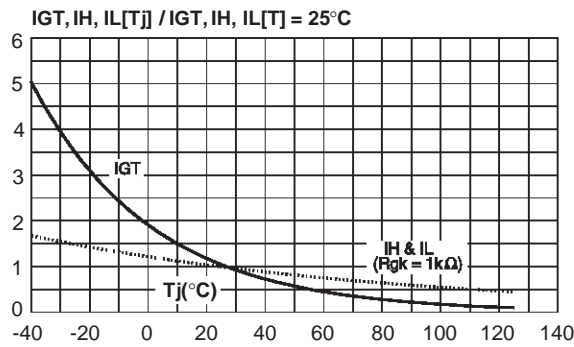

Fig. 6: Relative variation of dV/dt immunity versus gate-cathode resistance (typical values).

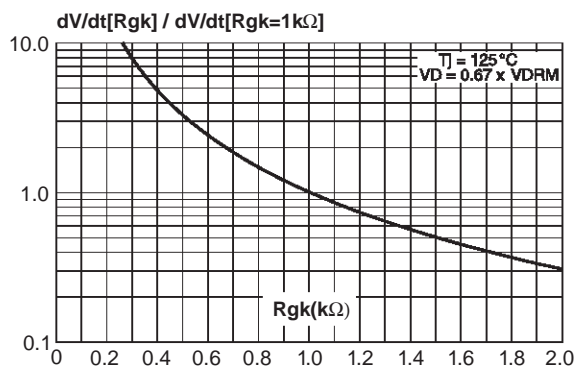

Fig. 8: Surge peak on-state current versus number of cycles.

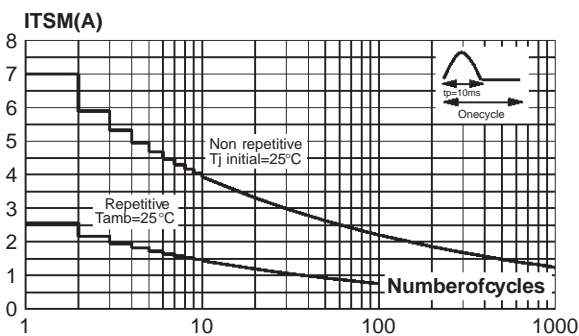

Fig. 5: Relative variation of holding current versus gate-cathode resistance (typical values).

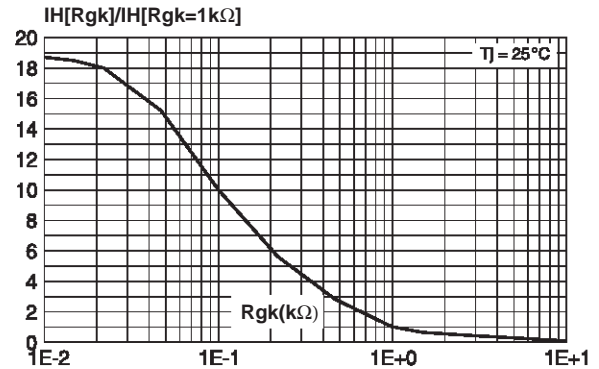

Fig. 7: Relative variation of dV/dt immunity versus gate-cathode capacitance (typical values).

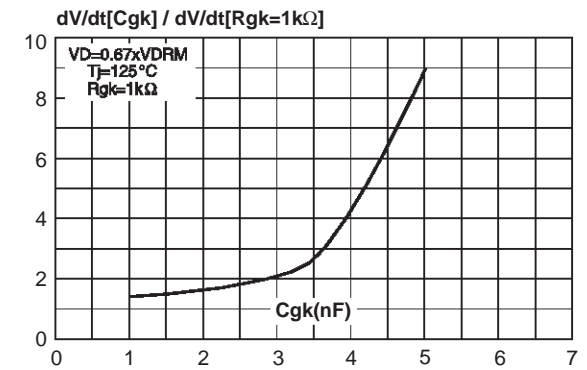

Fig. 9: Non-repetitive surge peak on-state current for a sinusoidal pulse with width tp < 10 ms, and corresponding value of I t.

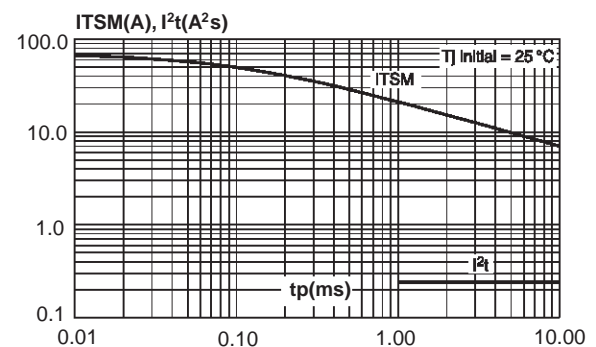
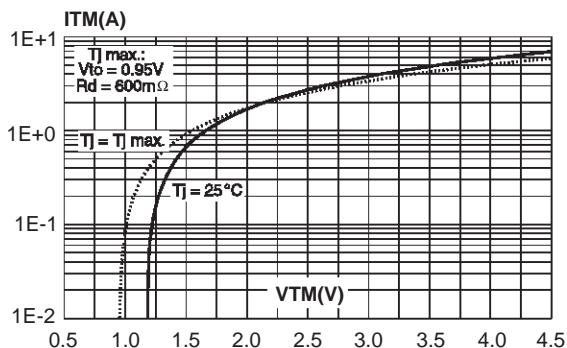
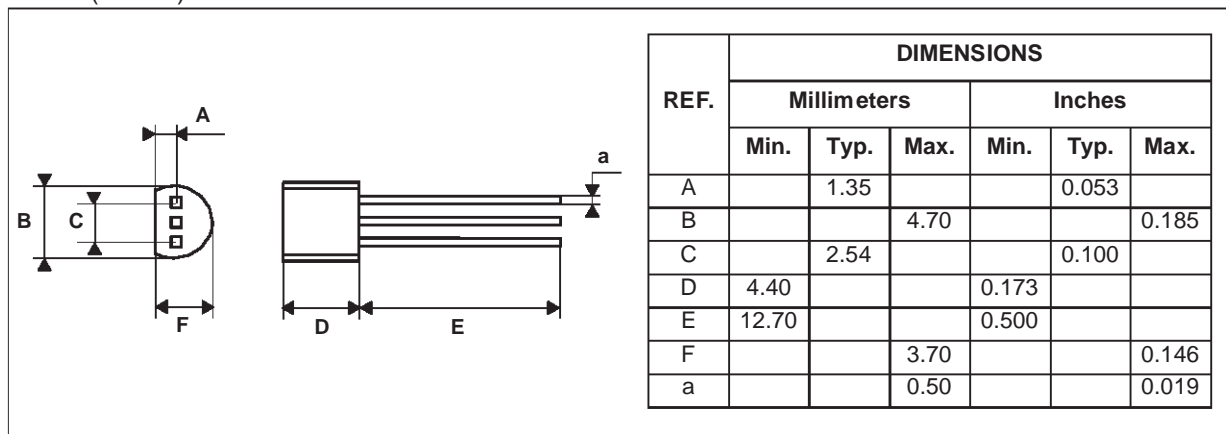

Fig. 10: On-state characteristics (maximum values).



PACKAGE MECHANICAL DATA

TO-92 (Plastic)



Information furnished is believed to be accurate and reliable. However, STMicroelectronics assumes no responsibility for the consequences of use of such information nor for any infringement of patents or other rights of third parties which may result from its use. No license is granted by implication or otherwise under any patent or patent rights of STMicroelectronics. Specifications mentioned in this publication are subject to change without notice. This publication supersedes and replaces all information previously supplied. STMicroelectronics products are not authorized for use as critical components in life support devices or systems without express written approval of STMicroelectronics.

© The ST logo is a registered trademark of STMicroelectronics

© 2002 STMicroelectronics - Printed in Italy - All Rights Reserved

STMicroelectronics GROUP OF COMPANIES
 Australia - Brazil - Canada - China - Finland - France - Germany
 Hong Kong - India - Israel - Italy - Japan - Malaysia - Malta - Morocco - Singapore
 Spain - Sweden - Switzerland - United Kingdom - United States

<http://www.st.com>

