

**PLEASE CHECK WWW.MOLEX.COM FOR LATEST PART INFORMATION**

**Part Number:** [0874271443](#)  
**Status:** **Active**  
**Overview:** [minifit\\_jr](#)  
**Description:** 4.20mm (.165") Mini-Fit Jr.™ Header, Vertical, Nylon, without Flange, 14Circuits, Tin (Sn) over Copper (Cu) Plating, Glow Wire Compatible

**Documents:**

[3D Model](#) [Product Specification PS-87427-0001 \(PDF\)](#)  
[Drawing \(PDF\)](#) [RoHS Certificate of Compliance \(PDF\)](#)

**Agency Certification**

CSA LR19980  
 UL E29179

**General**

Product Family PCB Headers  
 Series [87427](#)  
 Application Wire-to-Board  
 Comments Current = 13A max. per circuit when header is mated to a receptacle loaded with [45750](#) Mini-Fit Plus HCS™ Crimp Terminal Crimped to to 16 AWG wire. . See Molex product specification PS-45750-001 for additional current de-rating information.

Overview [minifit\\_jr](#)  
 Product Name Mini-Fit Jr.™

**Physical**

Breakaway No  
 Circuits (Loaded) 14  
 Color - Resin Beige  
 Durability (mating cycles max) 30  
 First Mate / Last Break No  
 Flammability 94V-0  
 Glow-Wire Compliant Yes  
 Lock to Mating Part Yes  
 Material - Metal Brass  
 Material - Plating Mating Tin  
 Material - Plating Termination Tin  
 Material - Resin Nylon  
 Number of Rows 2  
 Orientation Vertical  
 PC Tail Length (in) 0.130 In  
 PC Tail Length (mm) 3.30 mm  
 PCB Locator No  
 PCB Retention None  
 PCB Thickness Recommended (in) 0.062 In  
 PCB Thickness Recommended (mm) 1.60 mm  
 Packaging Type Tray  
 Pitch - Mating Interface (in) 0.165 In  
 Pitch - Mating Interface (mm) 4.20 mm  
 Pitch - Term. Interface (in) 0.165 In  
 Pitch - Term. Interface (mm) 4.20 mm  
 Plating min: Mating (µin) 203.2  
 Plating min: Mating (µm) 5.08  
 Plating min: Termination (µin) 203.2  
 Plating min: Termination (µm) 5.08

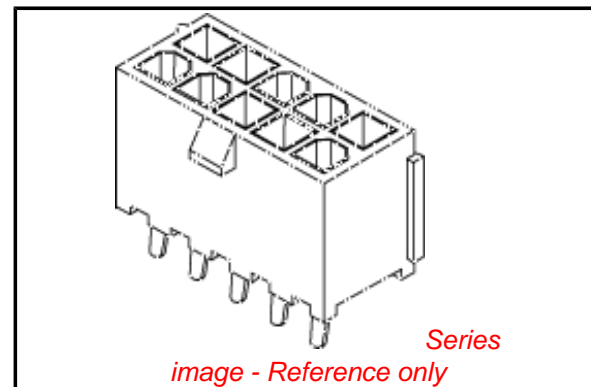

**EU RoHS**

**ELV and RoHS Compliant**  
**REACH SVHC Contains SVHC: No**  
**Halogen-Free**  
**Status**  
**Not Reviewed**

**China RoHS**



**Need more information on product environmental compliance?**

Email [productcompliance@molex.com](mailto:productcompliance@molex.com)  
 For a multiple part number RoHS Certificate of Compliance, [click here](#)

Please visit the [Contact Us](#) section for any non-product compliance questions.

**Search Parts in this Series**

[87427Series](#)

**Mates With**

[5557](#) Mini-Fit Jr.™ Receptacle Housing

Polarized to Mating Part	Yes
Polarized to PCB	No
Shrouded	Fully
Stackable	No
Surface Mount Compatible (SMC)	No
Temperature Range - Operating	-40°C to +105°C
Termination Interface: Style	Through Hole

### **Electrical**

Current - Maximum per Contact	13A
Voltage - Maximum	600V

### **Solder Process Data**

Duration at Max. Process Temperature (seconds)	30
Lead-free Process Capability	SMC & Wave Capable (TH only)
Max. Cycles at Max. Process Temperature	2
Process Temperature max. C	240

### **Material Info**

#### **Reference - Drawing Numbers**

Packaging Specification	PK-87427-004
Product Specification	PS-87427-0001
Sales Drawing	SD-87427-***4*

This document was generated on 05/31/2010

**PLEASE CHECK [WWW.MOLEX.COM](http://WWW.MOLEX.COM) FOR LATEST PART INFORMATION**

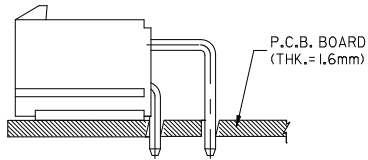
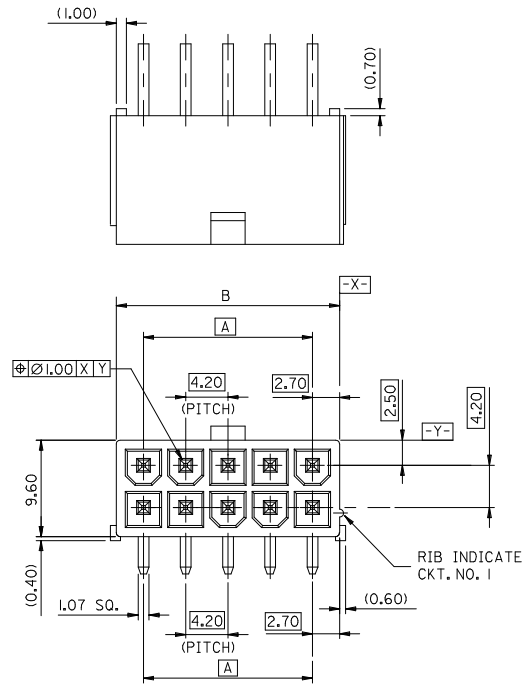

**RECOMMENDED INSTALLATION PATTERN**

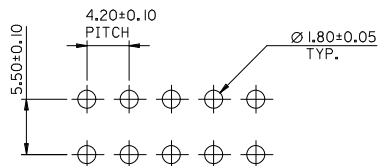

**RECOMMENDED P.C.B. LAYOUT**

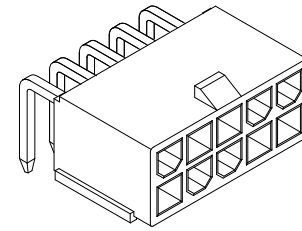

**ISOMETRIC VIEW**

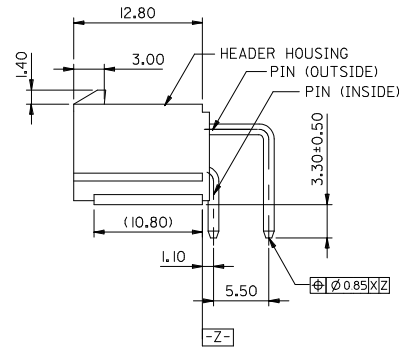

**LEGEND**

- 87427-\*\*\*\*
- CKT. SIZE (SEE SHEET 2).
  - PLATING OPTIONS
    - 2 = NOTE
    - 3 = NOTE
  - PACKAGING OPTIONS
    - 0 = TRAY PACKED
    - 2 = TUBE PACKED

**NOTES**

1. MATERIAL - HEADER : NYLON 46, UL94V-0, COLOR BEIGE  
PIN : BRASS (1.07 SQUARE)
2. PLATING OF PIN  
TIN 2.54um MIN. OVER NICKEL 1.27um MIN.
3. PLATING OF PIN  
TIN 4-10um OVER COPPER 2-8um.
4. PLATING OF PIN  
TIN 2.54um MIN. OVER NICKEL 1.27um MIN. WITH MATT FINISH.
5. PART NUMBERS 36633-0020 TO 36633-0024 & 36633-0040 TO 36633-0046 INCLUDED AS SHOWN IN TABLE 'X'.

CORRECT TOLERANCE EC NO: UCP2010-0395 DRAWN: JAGUILAR 2010/04/09 CHKD: EDMUD 1995/03/01 APPR: FSMITH 2010/04/09	QUALITY SYMBOLS ▽=0 C=0	GENERAL TOLERANCES (UNLESS SPECIFIED)		DIMENSION STYLE MM ONLY		SCALE 2:1	DESIGN UNITS METRIC	THIRD ANGLE PROJECTION	
		mm	INCH	DRAWN BY STEVEN	DATE 1995/02/27	TITLE 4.2MM W-T-B HIGH TEMP. RIGHT ANGLE HEADER WITHOUT MOUNTING FLANGES			
REV	DESCRIPTION	4 PLACES	± ---	± ---	CHECKED BY EDMUD	DATE 1995/03/01	MOLEX INCORPORATED		
		3 PLACES	± ---	± ---	APPROVED BY FSMITH	DATE 2010/04/09			
		2 PLACES	± 0.20	± ---	MATERIAL NO. SEE CHART		DOCUMENT NO. SD-87427-**0*	SHEET NO. 1 OF 2	
		1 PLACE	± 0.20	± ---	DRAFT WHERE APPLICABLE MUST REMAIN WITHIN DIMENSIONS				
		ANGULAR ± ---°		THIS DRAWING CONTAINS INFORMATION THAT IS PROPRIETARY TO MOLEX INCORPORATED AND SHOULD NOT BE USED WITHOUT WRITTEN PERMISSION					

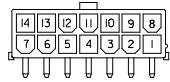

CKT.SIZE 14

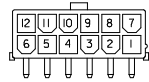

CKT.SIZE 12

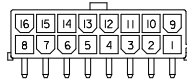

CKT.SIZE 16

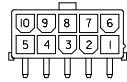

CKT.SIZE 10

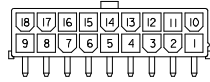

CKT.SIZE 18

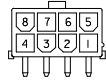

CKT.SIZE 8

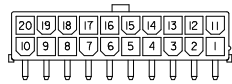

CKT.SIZE 20



CKT.SIZE 6

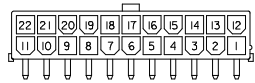

CKT.SIZE 22



CKT.SIZE 4

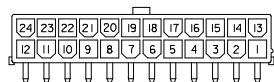

CKT.SIZE 24



CKT.SIZE 2

SEE NOTES $\Delta$ ON SHEET 1 FOR PLATING DETAILS	51.60	46.20	36633-0046	24
	47.40	42.00	36633-0045	22
	43.20	37.80	36633-0024	20
	39.00	33.60	36633-0044	18
	34.80	29.40	36633-0023	16
	30.60	25.20	36633-0043	14
	26.40	21.00	36633-0022	12
	22.20	16.80	36633-0021	10
	18.00	12.60	36633-0042	8
	13.80	8.40	36633-0041	6
	9.60	4.20	36633-0020	4
	5.40	--	36633-0040	2
PIN (OUTSIDE & INSIDE)	B	A	ENG. NO.	CKT. SIZE

TABLE 'X'

51.60	46.20	87427-242*	24
B	A	ENG. NO. TUBE PACKED	CKT. SIZE
51.60	46.20	87427-240*	24
47.40	42.00	87427-220*	22
43.20	37.80	87427-200*	20
39.00	33.60	87427-180*	18
34.80	29.40	87427-160*	16
30.60	25.20	87427-140*	14
26.40	21.00	87427-120*	12
22.20	16.80	87427-100*	10
18.00	12.60	87427-080*	8
13.80	8.40	87427-060*	6
9.60	4.20	87427-040*	4
5.40	--	87427-020*	2
B	A	ENG. NO. TRAY PACKED	CKT. SIZE

EC NO: I2009-0573 DRWN: HMR01 2009/11/11 CHKD: KPRASAD 2009/11/12 APPR: KPRASAD 2009/11/13	QUALITY SYMBOLS $\nabla=0$ $\square=0$	GENERAL TOLERANCES (UNLESS SPECIFIED)	DIMENSION STYLE <b>MM ONLY</b>	SCALE <b>1:1</b>	DESIGN UNITS <b>METRIC</b>	THIRD ANGLE PROJECTION
		4 PLACES $\pm$ --- $\pm$ --- 3 PLACES $\pm$ --- $\pm$ --- 2 PLACES $\pm$ 0.20 $\pm$ --- 1 PLACE $\pm$ 0.20 $\pm$ --- ANGULAR $\pm$ ---°	DRAWN BY SABC	DATE 1996/02/05	TITLE <b>4.2MM W-T-B,HIGH TEMP. RIGHT ANGLE HEADER WITHOUT MOUNTING FLANGES</b>	
		DRAFT WHERE APPLICABLE MUST REMAIN WITHIN DIMENSIONS	APPROVED BY	DATE	MOLEX INCORPORATED	
		MATERIAL NO. <b>SEE CHART</b>	DOCUMENT NO. <b>SD-87427-**0*</b>	SHEET NO. <b>2 OF 2</b>		