



2SC1384

NPN SILICON TRANSISTOR

NPN SILICON TRANSISTOR

DESCRIPTION

The UTC **2SC1384** is power amplifier and driver.

FEATURES

* Low $V_{CE(SAT)}$

* 2~3W output in complementary pair with 2SA684

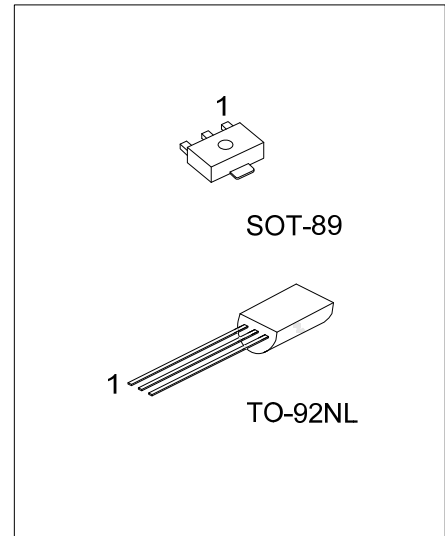

ORDERING INFORMATION

Ordering Number		Package	Pin Assignment			Packing
Lead Free	Halogen-Free		1	2	3	
2SC1384L-x-AB3-R	2SC1384G-x-AB3-R	SOT-89	B	C	E	Tape Reel
2SC1384L-x-T9N-B	2SC1384G-x-T9N-B	TO-92NL	E	C	B	Tape Box
2SC1384L-x-T9N-K	2SC1384G-x-T9N-K	TO-92NL	E	C	B	Bulk
2SC1384L-x-T9N-R	2SC1384G-x-T9N-R	TO-92NL	E	C	B	Tape Reel

<p>2SC1384L-x-AB3-B</p>	<p>(1) K: Bulk, T: Tube, R: Tape Reel (2) AB3: SOT-89, T9N: TO-92NL (3) x: refer to Classification of h_{FE} (4) G: Halogen Free, L: Lead Free</p>
-------------------------	--

■ ABSOLUTE MAXIMUM RATINGS ($T_A=25^\circ\text{C}$, unless otherwise specified)

PARAMETER	SYMBOL	RATINGS	UNIT
Collector-Base Voltage	V_{CBO}	60	V
Collector-Emitter Voltage	V_{CEO}	50	V
Emitter-Base Voltage	V_{EBO}	5	V
Peak Collector Current	I_{CP}	1.5	A
Collector Current (DC)	I_C	1	A
Collector Dissipation ($T_A=25^\circ\text{C}$)	P_C	1000	mW
Junction Temperature	T_J	125	$^\circ\text{C}$
Operating Temperature	T_{OPR}	-20 ~ +85	$^\circ\text{C}$
Storage Temperature	T_{STG}	-40 ~ +150	$^\circ\text{C}$

Note: Absolute maximum ratings are those values beyond which the device could be permanently damaged.

Absolute maximum ratings are stress ratings only and functional device operation is not implied.

■ ELECTRICAL CHARACTERISTICS ($T_A=25^\circ\text{C}$, unless otherwise specified)

PARAMETER	SYMBOL	TEST CONDITIONS	MIN	TYP	MAX	UNIT
Collector-Base Breakdown Voltage	BV_{CBO}	$I_C=10\mu\text{A}$, $I_E=0$	60			V
Collector-Emitter Breakdown Voltage	BV_{CEO}	$I_C=2\text{mA}$, $I_B=0$	50			V
Emitter-Base Breakdown Voltage	BV_{EBO}	$I_E=10\mu\text{A}$, $I_C=0$	5			V
Collector Cut-Off Current	I_{CBO}	$V_{CB}=20\text{V}$, $I_E=0$			0.1	μA
DC Current Gain	h_{FE1}	$V_{CE}=10\text{V}$, $I_C=500\text{mA}$	85	160	340	
	h_{FE2}	$V_{CE}=5\text{V}$, $I_C=1\text{A}$	50	100		
Collector-Emitter Saturation Voltage	$V_{CE(SAT)}$	$I_C=0.5\text{A}$, $I_B=50\text{mA}$		0.2	0.4	V
Base-Emitter Saturation Voltage	$V_{BE(SAT)}$	$I_C=0.5\text{A}$, $I_B=50\text{mA}$		0.85	1.2	V
Current Gain Bandwidth Product	f_T	$V_{CE}=10\text{V}$, $I_B=50\text{mA}$		200		MHz
Output Capacitance	C_{OB}	$V_{CB}=10\text{V}$, $I_E=0$, $f=1\text{MHz}$		11	20	pF

■ CLASSIFICATION OF h_{FE}

RANK	Q	R	S
RANGE	85-170	120-240	170-340

TYPICAL CHARACTERISTICS

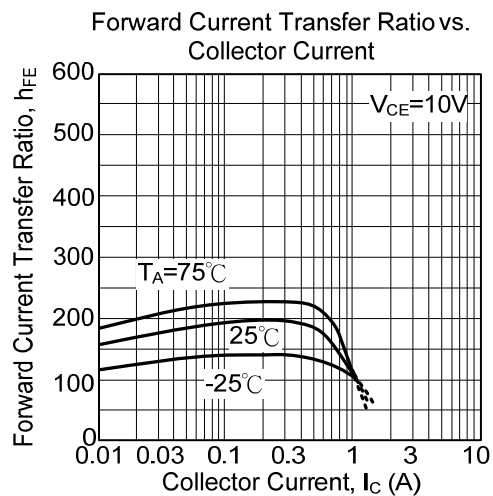
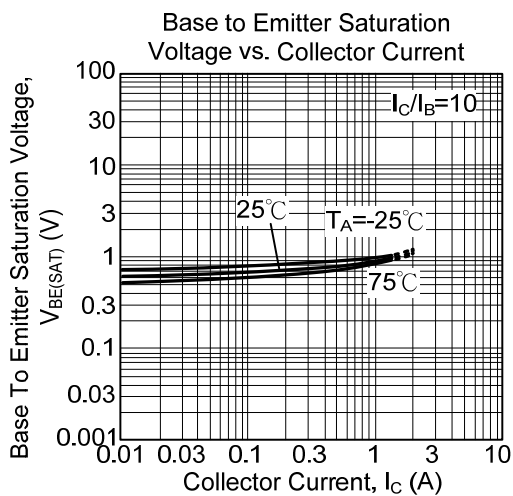
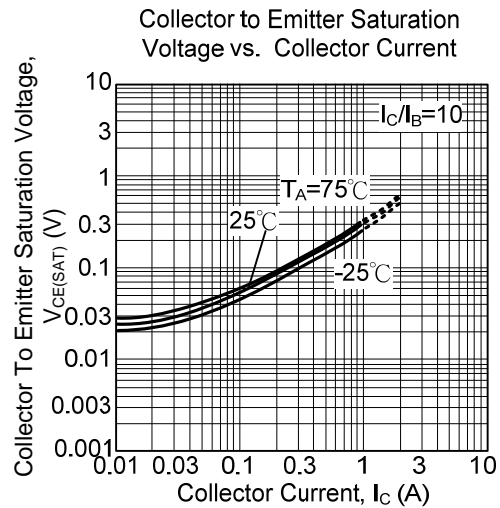
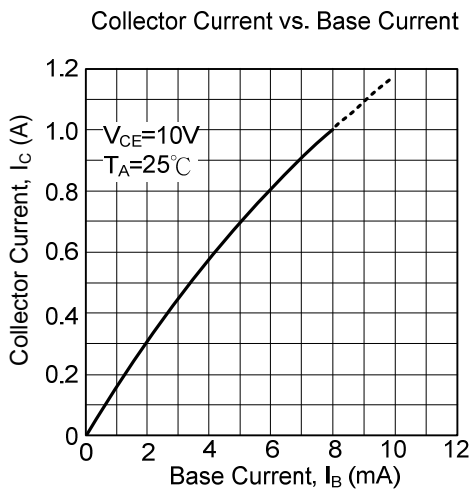
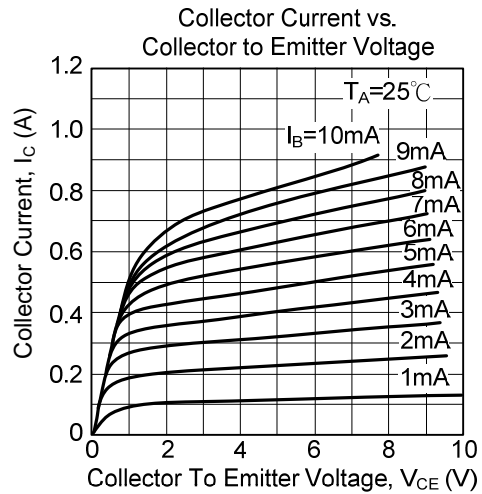
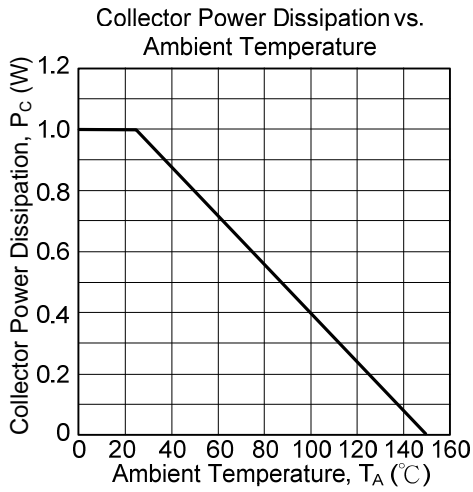

■ TYPICAL CHARACTERISTICS(Cont.)

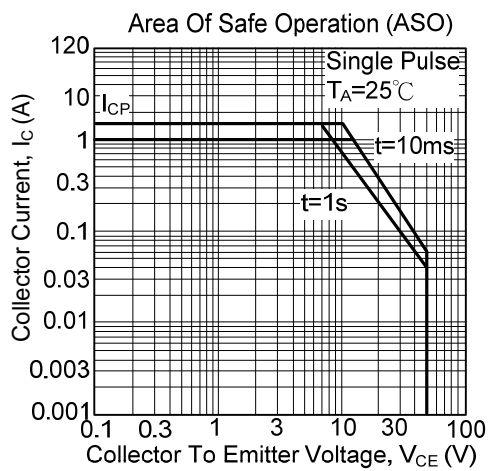
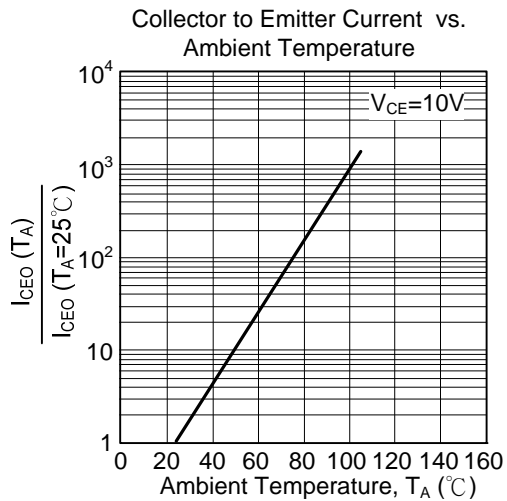
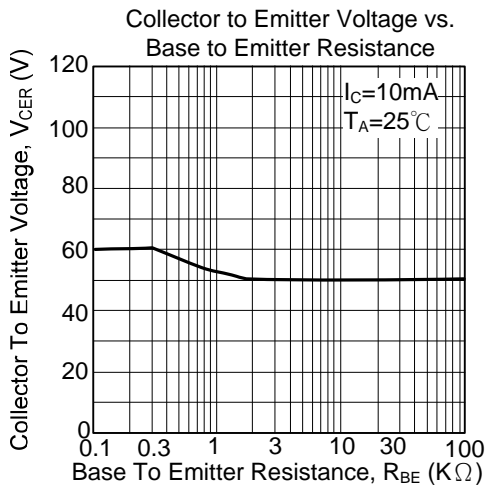
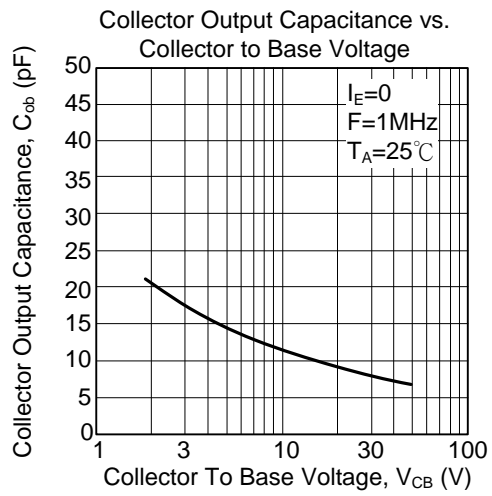
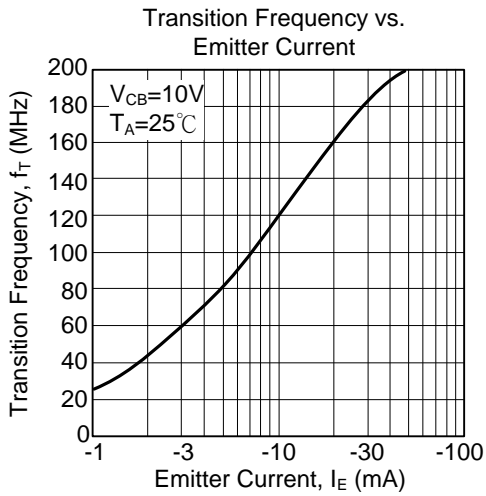

UTC assumes no responsibility for equipment failures that result from using products at values that exceed, even momentarily, rated values (such as maximum ratings, operating condition ranges, or other parameters) listed in products specifications of any and all UTC products described or contained herein. UTC products are not designed for use in life support appliances, devices or systems where malfunction of these products can be reasonably expected to result in personal injury. Reproduction in whole or in part is prohibited without the prior written consent of the copyright owner. The information presented in this document does not form part of any quotation or contract, is believed to be accurate and reliable and may be changed without notice.