

PLEASE CHECK WWW.MOLEX.COM FOR LATEST PART INFORMATION

Part Number: [0355721000](#)
Status: **Active**
Description: 2.50mm (.098") Pitch Wire-to-Wire and Wire-to-Board Housing, Positive Lock, Nylon 6/6 Material, 10 Circuits, Natural

Documents:

[3D Model](#) [Product Specification PS-35572-001 \(PDF\)](#)
[Drawing \(PDF\)](#) [RoHS Certificate of Compliance \(PDF\)](#)

General

Product Family Crimp Housings
 Series [35572](#)
 Product Name N/A

Physical

Breakaway No
 Circuits (maximum) 10
 Color - Resin Natural
 Gender Female
 Glow-Wire Compliant No
 Keying to Mating Part None
 Lock to Mating Part Yes
 Material - Resin Polyester
 Number of Rows 1
 Packaging Type Bag
 Panel Mount No
 Pitch - Mating Interface (in) 0.098 In
 Pitch - Mating Interface (mm) 2.50 mm
 Temperature Range - Operating -40°C to +105°C

Material Info

Reference - Drawing Numbers

Product Specification PS-35572-001
 Sales Drawing SD-35572-001

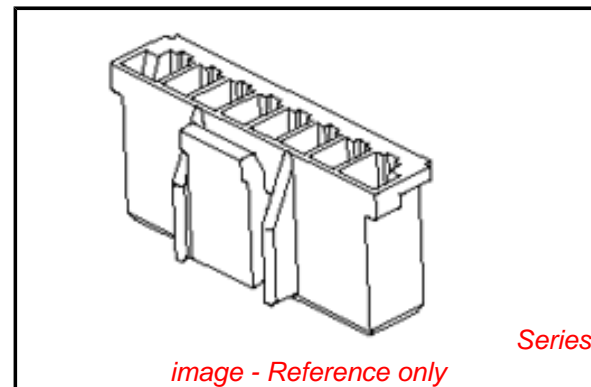

EU RoHS

ELV and RoHS Compliant
REACH SVHC Contains SVHC: No
Halogen-Free Status

China RoHS



Need more information on product environmental compliance?

Email productcompliance@molex.com
 For a multiple part number RoHS Certificate of Compliance, [click here](#)

Please visit the [Contact Us](#) section for any non-product compliance questions.

Search Parts in this Series

[35572Series](#)

Mates With

[35312](#) Vertical Shrouded Header, [35184](#) Plug Housing

Use With

[57915](#) Wire-to-Board Terminal

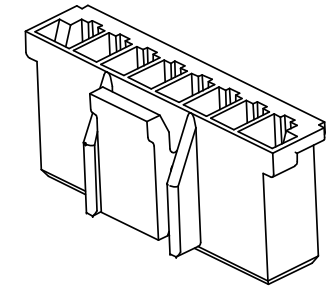
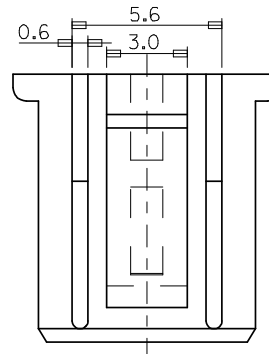
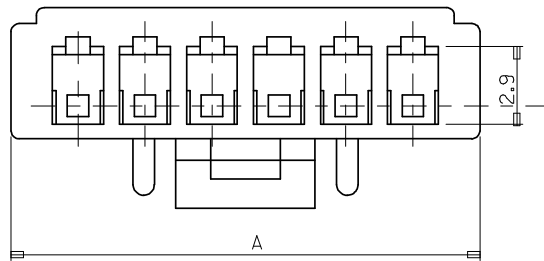

3 CKT ONLY

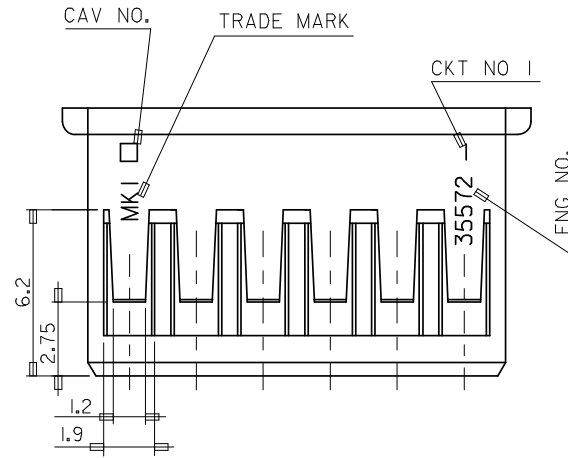
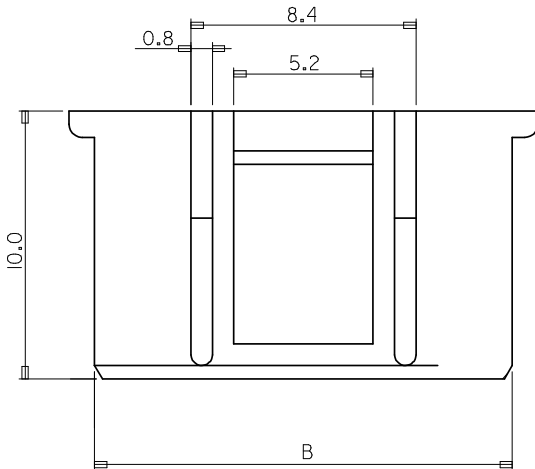
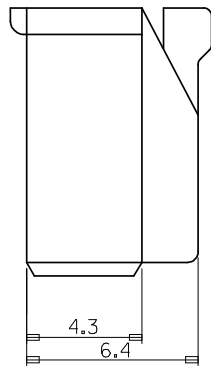

NOTE

1. MATERIAL : PBT UL94V-0 (VALOX 3IOSE0)
2. COLOR : 0 : NATURAL
2 : RED (ONLY 4P,6P,10P)
3. USED TERMINAL : 57915-9002/8001
4. MATED : 35312/35184

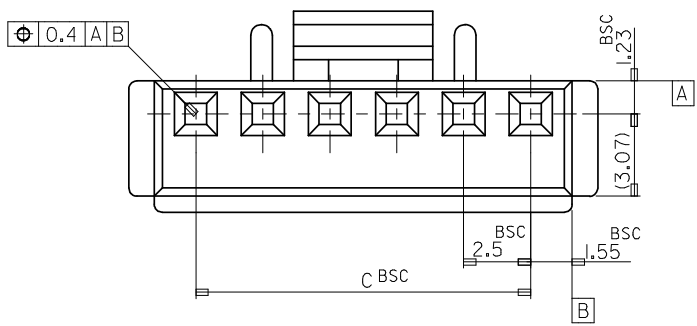

						20.0	23.1	25.0	35572-0900	9
35.0	38.1	40.0	35572-1500	15	17.5	20.6	22.5	35572-0800	8	
32.5	35.6	37.5	35572-1400	14	15.0	18.1	20.0	35572-0700	7	
30.0	33.1	35.0	35572-1300	13	12.5	15.6	17.5	35572-060*	6	
27.5	30.6	32.5	35572-1200	12	10.0	13.1	15.0	35572-0500	5	
25.0	28.1	30.0	35572-1100	11	7.5	10.6	12.5	35572-040*	4	
22.5	25.6	27.5	35572-100*	10	5.0	8.1	10.0	35572-0300	3	
C	B	A	ENG NO.	CKT	C	B	A	ENG NO.	CKT	

REVISED EC NO: KOR2008-0109 DRWN: JHPARK01 2008/01/02 CHKD: WY. YANG 2008/01/02 APPR: YUNS IKK IM 2008/01/02	QUALITY SYMBOLS ▽=0 ▽C=0	GENERAL TOLERANCES (UNLESS SPECIFIED)		DIMENSION STYLE MM ONLY		SCALE 5:1	DESIGN UNITS METRIC	THIRD ANGLE PROJECTION	
		mm	INCH	DRAWN BY HS. SHIN	DATE 2000/02/17	TITLE 2.5 PITCH W/B CONN HOUSING			
REV	DESCRIPTION	DRAFT WHERE APPLICABLE MUST REMAIN WITHIN DIMENSIONS		APPROVED BY CW. LEE		DATE 2000/02/17	MOLEX INCORPORATED		
				MATERIAL NO. SD35572.DGN		DOCUMENT NO. SD-35572-001	SHEET NO. 1 OF 01		
THIS DRAWING CONTAINS INFORMATION THAT IS PROPRIETARY TO MOLEX INCORPORATED AND SHOULD NOT BE USED WITHOUT WRITTEN PERMISSION									