



POKE HOME - THRU WIRE
(CONNECTS PAIRS OF WIRES)

00-9286-00X-021-X06

Elco Europe (A Division of AVX Ltd) CONFIDENTIAL PROPRIETY
The document on this print and information therewith are PROPRIETY
to Elco Europe (A Division of AVX Ltd) and shall not be copied
or disclosed in whole or in part without Elco Europe's written consent.

PREFIX _____

CODE	TYPE	DETAILS
00	POKE HOME	WIRE TO WIRE

SERIES _____

NO. OF WAYS _____

CODE	NO. OF WAYS	DETAILS
001	1	SHEET 2
002	2	SHEET 3
003	3	SHEET 4
004	4	SHEET 5
006	6	SHEET 6
008	8	SHEET 7

WIRE SIZE _____

CODE	WIRE GAUGE	MAX. CONDUCTOR	MAX. INSULATION
021	18 TO 26 AWG	1.05mm DIAMETER	2.10mm DIAMETER

COLOUR AND APPROVAL _____

CODE	COLOUR	AVAILABILITY
1	WHITE	STANDARD
9	WHITE	UL APPROVED - SPECIAL ORDER

PLATING OPTION _____

CODE	CONTACTS
06	TIN ALL OVER



ELCO EUROPE (A DIVISION OF AVX LTD.) CONFIDENTIAL PROPRIETARY
THE DRAWING ON THIS PRINT AND INFORMATION THEREWITH ARE
PROPRIETARY TO ELCO EUROPE (A DIVISION OF AVX LTD.) AND
SHALL NOT BE USED OR DISCLOSED IN WHOLE OR IN PART
WITHOUT ELCO EUROPE'S WRITTEN CONSENT.

SHEET 1 OF 9

Release No.	History
102717	19.04.2011
	28.04.2011
	06.09.2011
	01.11.2011
	11.11.2011
	30.11.2011
	08.02.2012
	20.06.2012

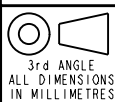

Drawn	Description	DATE
N.C.H.	POKE HOME CONNECTOR - THRU WIRE	14-Feb-11
Size	Part Number	Issue
CV	00-9286-01_000S	1

FORM-106-01-056-6 ISS 7

POKE HOME 1 WAY - THRU WIRE - 18AWG TO 26AWG

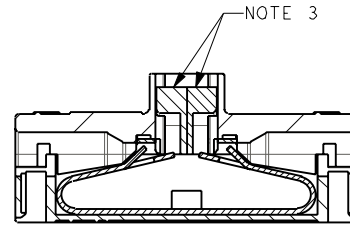
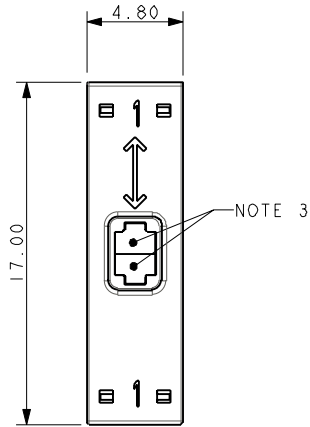

SECTION ON A-A

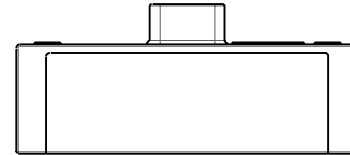
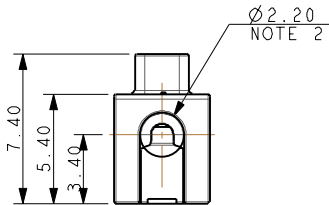

PACKING DETAILS

REEL Ø	330mm
MAX REEL WIDTH	22.4mm
LEADER	500mm
TRAILER	500mm
QTY PER REEL	400



NOTE 8

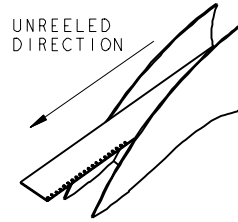
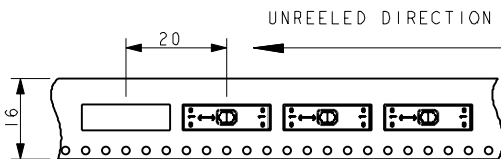

Elco Europe (A Division of AVX Ltd) CONFIDENTIAL PROPRIETY
The document on this print and information therewith are PROPRIETY
to Elco Europe (A Division of AVX Ltd) and shall not be copied
or disclosed in whole or in part without Elco Europe's written consent.

NOTES :-

1. 1 WAY WIRE TO WIRE "POKE HOME" CONNECTOR, BUTTON OPERATED.
2. WIRE SIZES 18-26AWG, MAXIMUM INSULATION DIAMETER 2.10mm.
3. SPLIT BUTTON ALLOWS THE WIRES TO BE INSERTED/WITHDRAWN INDEPENDENTLY.
4. INSULATION MATERIAL :- NYLON 46, GLASS FILLED, UL94 V-0, COLOUR SEE SHEET 1.
5. CONTACT MATERIAL :- TIN PLATED COPPER ALLOY.
6. FOR FULL SPECIFICATION REFER TO ELCO SPECIFICATION 201-01-132, UL COMPONENTS REFER TO ELCO SPECIFICATION 201-01-132UL. FOR APPLICATION NOTES REFER TO ELCO SPECIFICATION 201-01-135.
7. GENERAL TOLERANCE ±0.20mm.
8. WIRE STRIP LENGTH GUIDE, SEE SHEET 8.
9. ADHESIVE STRIP FOR PANEL MOUNTING, REFER TO SHEET 9.
10. FOR UL PRODUCT CODES UL REFERENCE E320991.

ELCO EUROPE (A DIVISION OF AVX LTD.) CONFIDENTIAL PROPRIETY
THE DRAWING ON THIS PRINT AND INFORMATION THEREWITH ARE
PROPRIETARY TO ELCO EUROPE (A DIVISION OF AVX LTD.) AND
SHALL NOT BE USED OR DISCLOSED IN WHOLE OR IN PART
WITHOUT ELCO EUROPE'S WRITTEN CONSENT.

SHEET 2 OF 9

Release No.	102717
History	19.04.2011
	28.04.2011
	06.09.2011
	01.11.2011
	11.11.2011
	30.11.2011
	08.02.2012
	20.06.2012

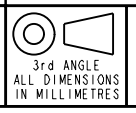

Drawn	N.C.H.	Description	POKE HOME CONNECTOR - THRU WIRE	DATE	09-Feb-11
Size	CV	Part Number	00-9286-01_000S	Issue	1

FORM-106-01-056-6 ISS 7

POKE HOME 2 WAY - THRU WIRE - 18AWG TO 26AWG

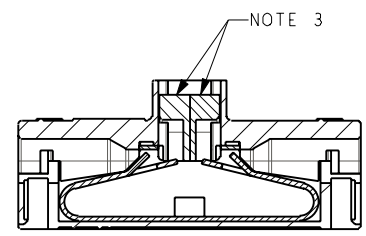
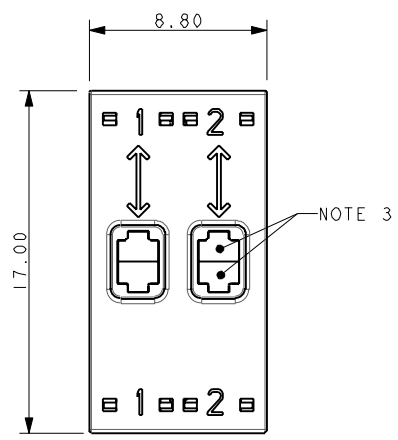

SECTION ON A-A

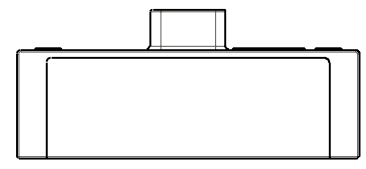
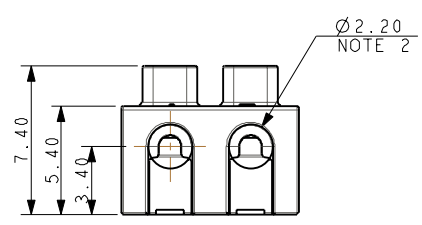

PACKING DETAILS

REEL Ø	330mm
MAX REEL WIDTH	30.4mm
LEADER	500mm
TRAILER	500mm
QTY PER REEL	400

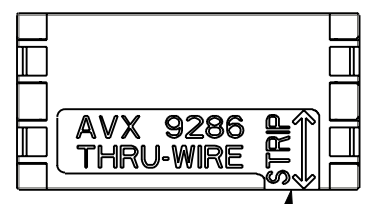

NOTE 8

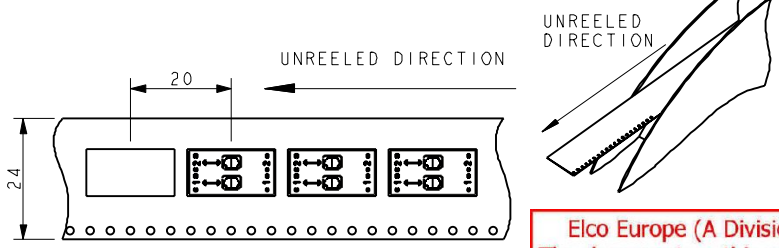

UNREELED DIRECTION

Elco Europe (A Division of AVX Ltd) CONFIDENTIAL PROPRIETY
The document on this print and information therewith are PROPRIETY
to Elco Europe (A Division of AVX Ltd) and shall not be copied
or disclosed in whole or in part without Elco Europe's written consent.

NOTES :-

1. 2 WAY WIRE TO WIRE "POKE HOME" CONNECTOR, BUTTON OPERATED.
2. WIRE SIZES 18-26AWG, MAXIMUM INSULATION DIAMETER 2.10mm.
3. SPLIT BUTTON ALLOWS THE WIRES TO BE INSERTED/WITHDRAWN INDEPENDENTLY.
4. INSULATION MATERIAL :- NYLON 46, GLASS FILLED, UL94 V-0, COLOUR SEE SHEET 1.
5. CONTACT MATERIAL :- TIN PLATED COPPER ALLOY.
6. FOR FULL SPECIFICATION REFER TO ELCO SPECIFICATION 201-01-132, UL COMPONENTS REFER TO ELCO SPECIFICATION 201-01-132UL. FOR APPLICATION NOTES REFER TO ELCO SPECIFICATION 201-01-135.
7. GENERAL TOLERANCE ±0.20mm.
8. WIRE STRIP LENGTH GUIDE, SEE SHEET 8.
9. ADHESIVE STRIP FOR PANEL MOUNTING, REFER TO SHEET 9.
10. FOR UL PRODUCT CODES UL REFERENCE E320991.

ELCO EUROPE (A DIVISION OF AVX LTD.) CONFIDENTIAL PROPRIETARY
THE DRAWING ON THIS PRINT AND INFORMATION THEREWITH ARE PROPRIETARY TO ELCO EUROPE (A DIVISION OF AVX LTD.) AND SHALL NOT BE USED OR DISCLOSED IN WHOLE OR IN PART WITHOUT ELCO EUROPE'S WRITTEN CONSENT.

SHEET 3 OF 9

Release No.	102717
History	19.04.2011 28.04.2011 06.09.2011 01.11.2011 11.11.2011 30.11.2011 08.02.2012 20.06.2012

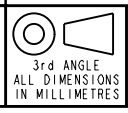

ELCO
© COPYRIGHT ELCO EUROPE
NOT TO BE DISCLOSED OR COPIED
WITHOUT WRITTEN PERMISSION

Drawn
N.C.H.
Size
CV

Description
POKE HOME CONNECTOR - THRU WIRE
Part Number
00-9286-01_000S

DATE
09-Feb-11
Issue
1

FORM-106-01-056-6 ISS 7

POKE HOME 3 WAY - THRU WIRE - 18AWG TO 26AWG

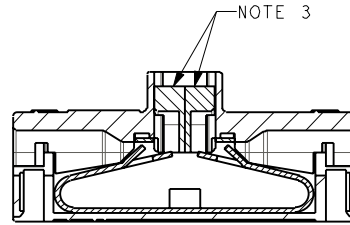
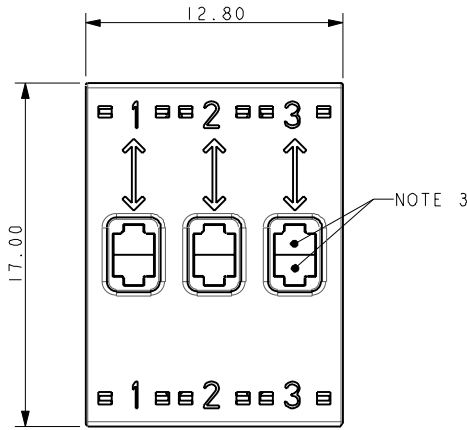

SECTION ON A-A

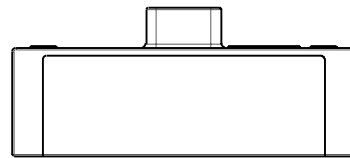
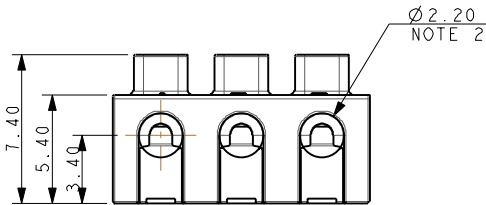

PACKING DETAILS

REEL Ø	330mm
MAX REEL WIDTH	30.4mm
LEADER	500mm
TRAILER	500mm
QTY PER REEL	400

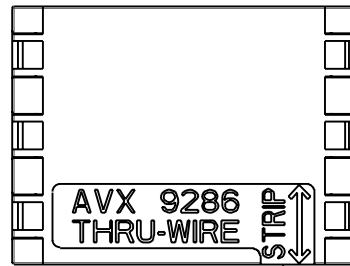

NOTE 8

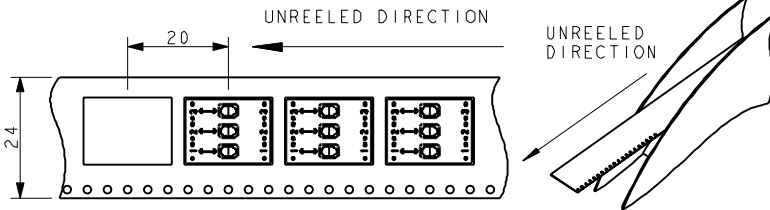

Elco Europe (A Division of AVX Ltd) CONFIDENTIAL PROPRIETY
The document on this print and information therewith are PROPRIETY
to Elco Europe (A Division of AVX Ltd) and shall not be copied
or disclosed in whole or in part without Elco Europe's written consent.

NOTES :-

1. 3 WAY WIRE TO WIRE "POKE HOME" CONNECTOR, BUTTON OPERATED.
2. WIRE SIZES 18-26AWG, MAXIMUM INSULATION DIAMETER 2.10mm.
3. SPLIT BUTTON ALLOWS THE WIRES TO BE INSERTED/WITHDRAWN INDEPENDENTLY.
4. INSULATION MATERIAL :- NYLON 46, GLASS FILLED, UL94 V-0, COLOUR SEE SHEET 1.
5. CONTACT MATERIAL :- TIN PLATED COPPER ALLOY.
6. FOR FULL SPECIFICATION REFER TO ELCO SPECIFICATION 201-01-132, UL COMPONENTS REFER TO ELCO SPECIFICATION 201-01-132UL. FOR APPLICATION NOTES REFER TO ELCO SPECIFICATION 201-01-135.
7. GENERAL TOLERANCE ±0.20mm.
8. WIRE STRIP LENGTH GUIDE, SEE SHEET 8.
9. ADHESIVE STRIP FOR PANEL MOUNTING, REFER TO SHEET 9.
10. FOR UL PRODUCT CODES UL REFERENCE E320991.

ELCO EUROPE (A DIVISION OF AVX LTD.) CONFIDENTIAL PROPRIETY
THE DRAWING ON THIS PRINT AND INFORMATION THEREWITH ARE
PROPRIETARY TO ELCO EUROPE (A DIVISION OF AVX LTD.) AND
SHALL NOT BE USED OR DISCLOSED IN WHOLE OR IN PART
WITHOUT ELCO EUROPE'S WRITTEN CONSENT.

SHEET 4 OF 9

Release No.	102717
History	19.04.2011
	28.04.2011
	06.09.2011
	01.11.2011
	11.11.2011
	30.11.2011
	08.02.2012
	20.06.2012

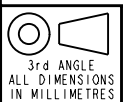

ELCO
© COPYRIGHT ELCO EUROPE
NOT TO BE DISCLOSED OR COPIED
WITHOUT WRITTEN PERMISSION

Drawn	N.C.H.
Size	CV

Description	POKE HOME CONNECTOR - THRU WIRE
Part Number	00-9286-01_000S

DATE	09-Feb-11
Issue	1

A

B

POKE HOME 4 WAY - THRU WIRE - 18AWG TO 26AWG

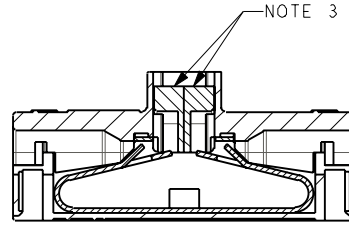
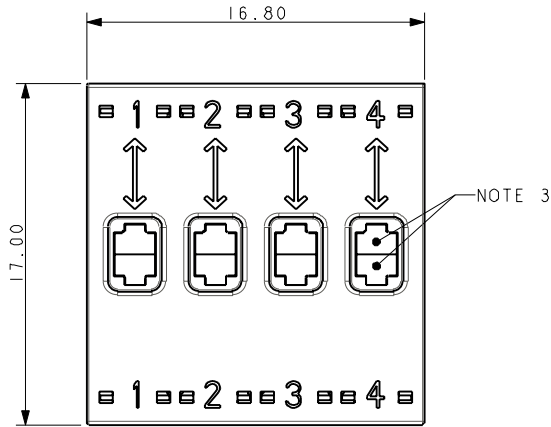

SECTION ON A-A

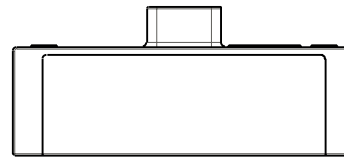
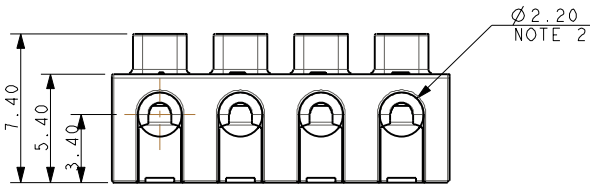

PACKING DETAILS

REEL Ø	330mm
MAX REEL WIDTH	38.4mm
LEADER	500mm
TRAILER	500mm
QTY PER REEL	400

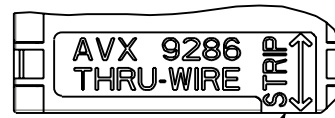

NOTE 8

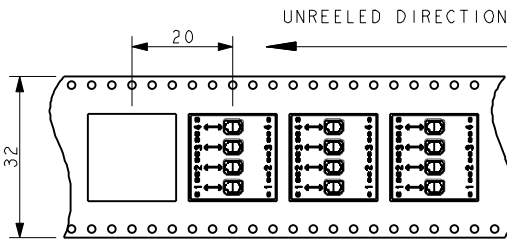

UNREELED DIRECTION

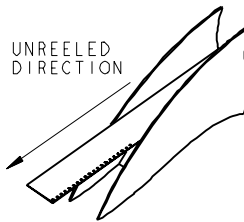

Elco Europe (A Division of AVX Ltd) CONFIDENTIAL PROPRIETY
The document on this print and information therewith are PROPRIETY
to Elco Europe (A Division of AVX Ltd) and shall not be copied
or disclosed in whole or in part without Elco Europe's written consent.

NOTES :-

1. 4 WAY WIRE TO WIRE "POKE HOME" CONNECTOR, BUTTON OPERATED.
2. WIRE SIZES 18-26AWG, MAXIMUM INSULATION DIAMETER 2.10mm.
3. SPLIT BUTTON ALLOWS THE WIRES TO BE INSERTED/WITHDRAWN INDEPENDENTLY.
4. INSULATION MATERIAL :- NYLON 46, GLASS FILLED, UL94 V-0, COLOUR SEE SHEET 1.
5. CONTACT MATERIAL :- TIN PLATED COPPER ALLOY.
6. FOR FULL SPECIFICATION REFER TO ELCO SPECIFICATION 201-01-132, UL COMPONENTS REFER TO ELCO SPECIFICATION 201-01-132UL. FOR APPLICATION NOTES REFER TO ELCO SPECIFICATION 201-01-135.
7. GENERAL TOLERANCE ±0.20mm.
8. WIRE STRIP LENGTH GUIDE, SEE SHEET 8.
9. ADHESIVE STRIP FOR PANEL MOUNTING, REFER TO SHEET 9.
10. FOR UL PRODUCT CODES UL REFERENCE E320991.

ELCO EUROPE (A DIVISION OF AVX LTD.) CONFIDENTIAL PROPRIETY
THE DRAWING ON THIS PRINT AND INFORMATION THEREWITH ARE
PROPRIETARY TO ELCO EUROPE (A DIVISION OF AVX LTD.) AND
SHALL NOT BE USED OR DISCLOSED IN WHOLE OR IN PART
WITHOUT ELCO EUROPE'S WRITTEN CONSENT.

SHEET 5 OF 9

Release No.	102717
History	19.04.2011
	28.04.2011
	06.09.2011
	01.11.2011
	11.11.2011
	30.11.2011
	08.02.2012
	20.06.2012

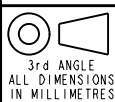

Drawn	N.C.H.
Size	CV

Description	POKE HOME CONNECTOR - THRU WIRE
Part Number	00-9286-01_000S

DATE	09-Feb-11
Issue	1

POKE HOME 6 WAY - THRU WIRE - 18AWG TO 26AWG

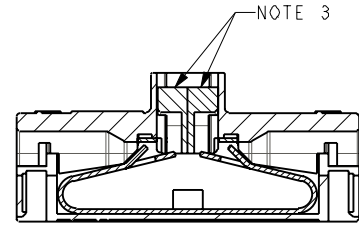
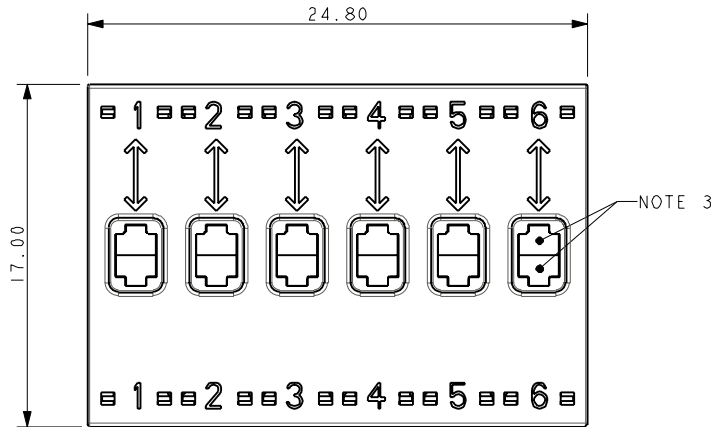

SECTION ON A-A

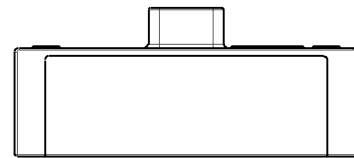
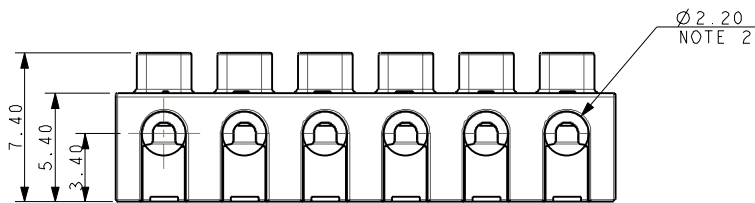

PACKING DETAILS

REEL Ø	330mm
MAX REEL WIDTH	50.4mm
LEADER	500mm
TRAILER	500mm
QTY PER REEL	400



NOTE 8

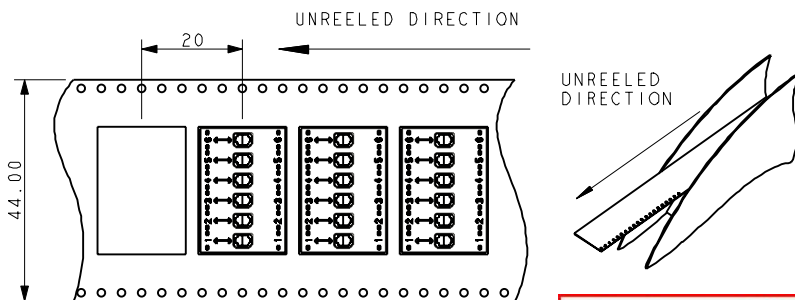

Elco Europe (A Division of AVX Ltd) CONFIDENTIAL PROPRIETY
The document on this print and information therewith are PROPRIETY
to Elco Europe (A Division of AVX Ltd) and shall not be copied
or disclosed in whole or in part without Elco Europe's written consent.

NOTES :-

1. 6 WAY WIRE TO WIRE "POKE HOME" CONNECTOR, BUTTON OPERATED.
2. WIRE SIZES 18-26AWG, MAXIMUM INSULATION DIAMETER 2.10mm.
3. SPLIT BUTTON ALLOWS THE WIRES TO BE INSERTED/WITHDRAWN INDEPENDENTLY.
4. INSULATION MATERIAL :- NYLON 46, GLASS FILLED, UL94 V-0, COLOUR SEE SHEET 1.
5. CONTACT MATERIAL :- TIN PLATED COPPER ALLOY.
6. FOR FULL SPECIFICATION REFER TO ELCO SPECIFICATION 201-01-132, UL COMPONENTS REFER TO ELCO SPECIFICATION 201-01-132UL. FOR APPLICATION NOTES REFER TO ELCO SPECIFICATION 201-01-135.
7. GENERAL TOLERANCE ±0.20mm.
8. WIRE STRIP LENGTH GUIDE, SEE SHEET 8.
9. ADHESIVE STRIP FOR PANEL MOUNTING, REFER TO SHEET 9.
10. FOR UL PRODUCT CODES UL REFERENCE E320991.

ELCO EUROPE (A DIVISION OF AVX LTD.) CONFIDENTIAL PROPRIETY
THE DRAWING ON THIS PRINT AND INFORMATION THEREWITH ARE
PROPRIETARY TO ELCO EUROPE (A DIVISION OF AVX LTD.) AND
SHALL NOT BE USED OR DISCLOSED IN WHOLE OR IN PART
WITHOUT ELCO EUROPE'S WRITTEN CONSENT.

SHEET 6 OF 9

Release No.	102717
History	19.04.2011 28.04.2011 06.09.2011 01.11.2011 11.11.2011 30.11.2011 08.02.2012 20.06.2012

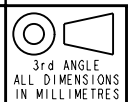

ELCO
© COPYRIGHT ELCO EUROPE
NOT TO BE DISCLOSED OR COPIED
WITHOUT WRITTEN PERMISSION

Drawn
N.C.H.
Size
CV

Description
POKE HOME CONNECTOR - THRU WIRE
Part Number
00-9286-01_000S

DATE
09-Feb-11
Issue
1

A

B

FORM-106-01-056-6 ISS 7

POKE HOME 8 WAY - THRU WIRE - 18AWG TO 26AWG

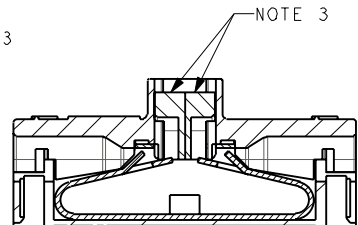
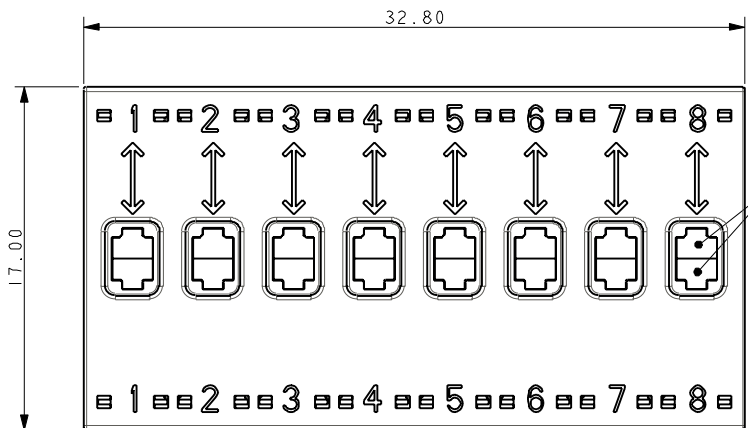

SECTION ON A-A

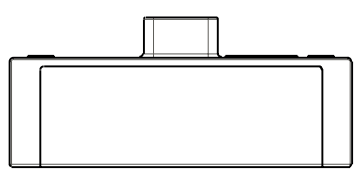
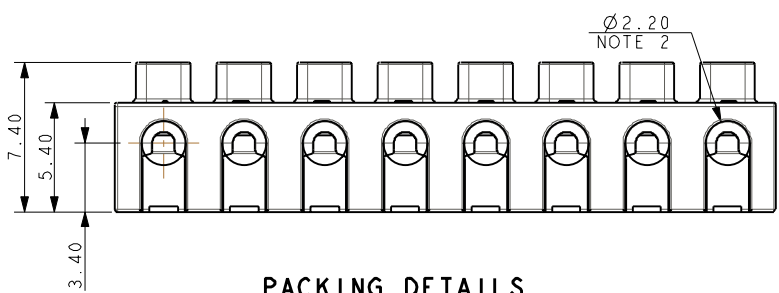

PACKING DETAILS

REEL Ø	330mm
MAX REEL WIDTH	62.4mm
LEADER	500mm
TRAILER	500mm
QTY PER REEL	400



NOTE 8

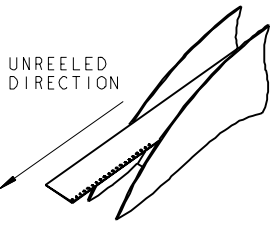
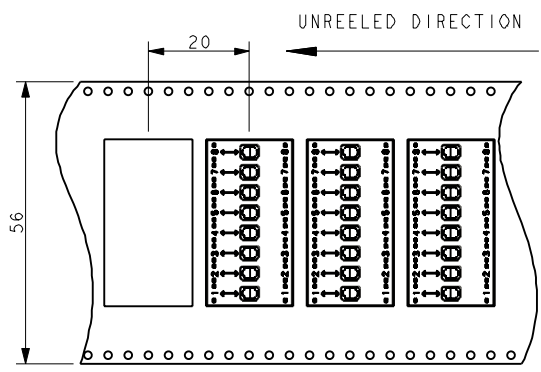

Elco Europe (A Division of AVX Ltd) CONFIDENTIAL PROPRIETY
The document on this print and information therewith are PROPRIETY
to Elco Europe (A Division of AVX Ltd) and shall not be copied
or disclosed in whole or in part without Elco Europe's written consent.

- NOTES :-
- 8 WAY WIRE TO WIRE "POKE HOME" CONNECTOR, BUTTON OPERATED.
 - WIRE SIZES 18-26AWG, MAXIMUM INSULATION DIAMETER 2.10mm.
 - SPLIT BUTTON ALLOWS THE WIRES TO BE INSERTED/WITHDRAWN INDEPENDENTLY.
 - INSULATION MATERIAL :- NYLON 46, GLASS FILLED, UL94 V-0, COLOUR SEE SHEET 1.
 - CONTACT MATERIAL :- TIN PLATED COPPER ALLOY.
 - FOR FULL SPECIFICATION REFER TO ELCO SPECIFICATION 201-01-132, UL COMPONENTS REFER TO ELCO SPECIFICATION 201-01-132UL. FOR APPLICATION NOTES REFER TO ELCO SPECIFICATION 201-01-135.
 - GENERAL TOLERANCE ± 0.20 mm.
 - WIRE STRIP LENGTH GUIDE, SEE SHEET 8.
 - ADHESIVE STRIP FOR PANEL MOUNTING, REFER TO SHEET 9.
 - FOR UL PRODUCT CODES UL REFERENCE E320991.

ELCO EUROPE (A DIVISION OF AVX LTD.) CONFIDENTIAL PROPRIETARY
THE DRAWING ON THIS PRINT AND INFORMATION THEREWITH ARE
PROPRIETARY TO ELCO EUROPE (A DIVISION OF AVX LTD.) AND
SHALL NOT BE USED OR DISCLOSED IN WHOLE OR IN PART
WITHOUT ELCO EUROPE'S WRITTEN CONSENT.

SHEET 7 OF 9

Release No.	102717
History	19.04.2011
	28.04.2011
	06.09.2011
	01.11.2011
	11.11.2011
	30.11.2011
	08.02.2012
	20.06.2012

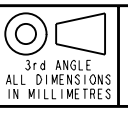

Drawn	N.C.H.	Description	POKE HOME CONNECTOR - THRU WIRE	DATE	09-Feb-11
Size	CV	Part Number	00-9286-01_000S	Issue	1

FORM-106-01-056-6 ISS 7

A

B

POKE HOME BUTTON ACTIVATION TOOL



SINGLE BUTTON OPERATION

Elco Europe (A Division of AVX Ltd) CONFIDENTIAL PROPRIETY
The document on this print and information therewith are PROPRIETY
to Elco Europe (A Division of AVX Ltd) and shall not be copied
or disclosed in whole or in part without Elco Europe's written consent.

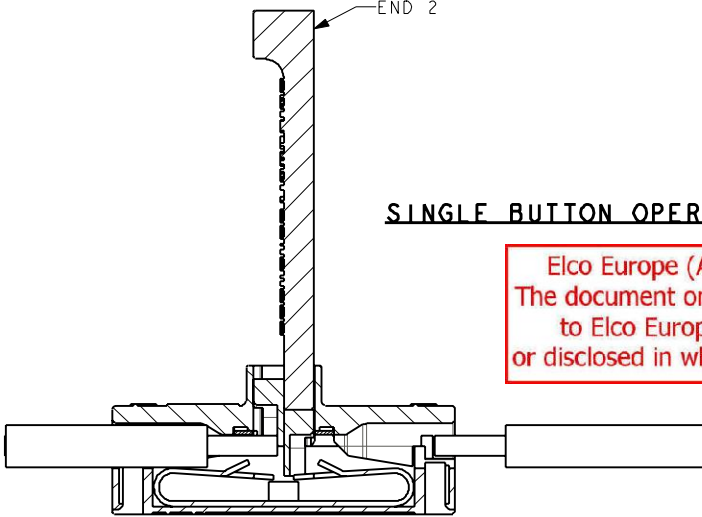

SIMULTANEOUS BUTTON OPERATION

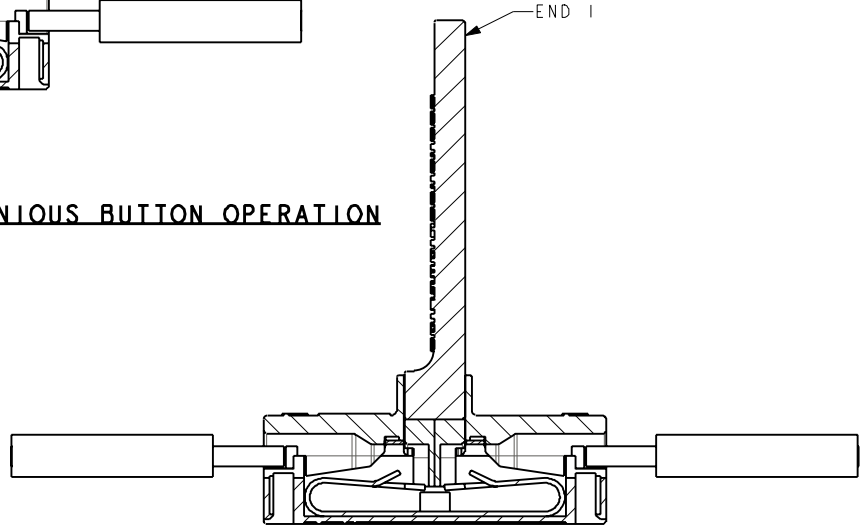

4.00±0.50 NOTE 2

TRIMMED WIRE

9286 BUTTON ACTIVATION TOOL
06-9286-7001-01-000

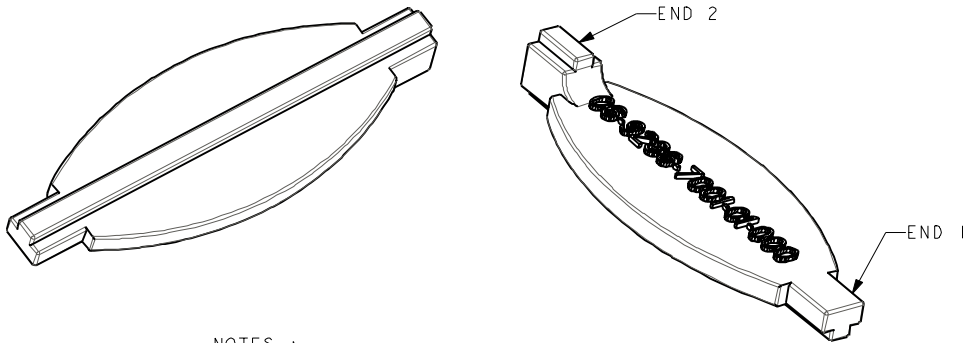

NOTES :-

1. TOOL IS DOUBLE ENDED, END 1 ACTIVATES SINGLE BUTTON, END 2 FOR SIMULTANEOUS BUTTON ACTIVATION.
2. WIRE WHEN TRIMMED TO BE STRAIGHT WITH NO BURRS.
3. FOR FULL ASSEMBLY DETAILS REFER TO APPLICATION NOTES 201-01-135.
4. SUPPLIED IN PACKS OF 100 PIECES.

SHEET 8 OF 9

FORM-106-01-056-6 ISS 7

ELCO EUROPE (A DIVISION OF AVX LTD.) CONFIDENTIAL PROPRIETARY
 THE DRAWING ON THIS PRINT AND INFORMATION THEREWITH ARE
 PROPRIETARY TO ELCO EUROPE (A DIVISION OF AVX LTD.) AND
 SHALL NOT BE USED OR DISCLOSED IN WHOLE OR IN PART
 WITHOUT ELCO EUROPE'S WRITTEN CONSENT.

Release No.
History
102717
19.04.2011
28.04.2011
06.09.2011
01.11.2011
11.11.2011
30.11.2011
08.02.2012
20.06.2012

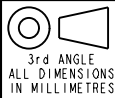

ELCO
 © COPYRIGHT ELCO EUROPE
 NOT TO BE DISCLOSED OR COPIED
 WITHOUT WRITTEN PERMISSION

Drawn
N.C.H.
Size
CV

Description
POKE HOME CONNECTOR - THRU WIRE
Part Number
00-9286-01_000S

DATE
02-Mar-11
Issue
1

A

B

80-9286-400X-00-000 ADHESIVE MOUNTING TAPE
 ACCESSORY - NOT SUPPLIED WITH CONNECTORS



Elco Europe (A Division of AVX Ltd) CONFIDENTIAL PROPRIETY
 The document on this print and information therewith are PROPRIETY
 to Elco Europe (A Division of AVX Ltd) and shall not be copied
 or disclosed in whole or in part without Elco Europe's written consent.

TAPE APPLIED TO CENTRE OF BASE

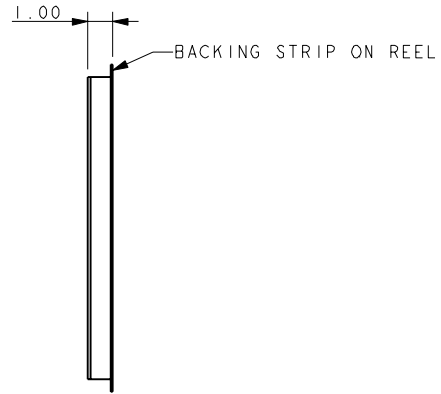
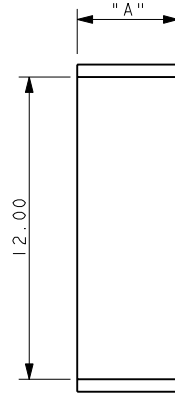
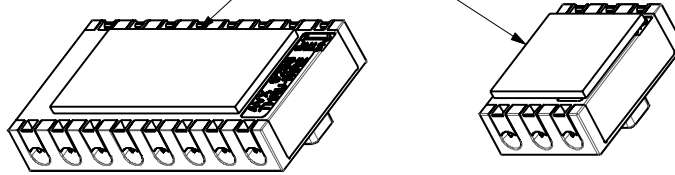

PART NUMBER	DIMENSION "A"	MATCHING CONNECTORS	
		00-9286-00X-021-X06 THRU WIRE	00-9286-00X-121-X06 JUNCTION BOX
80-9286-4001-00-000	4.00	1 WAY	N/A
80-9286-4002-00-000	8.00	2 WAY	4 WAY
80-9286-4003-00-000	12.00	3 AND 4 WAY	6 AND 8 WAY
80-9286-4006-00-000	24.00	6 AND 8 WAY	N/A

- NOTES :-
- DOUBLE SIDED FOAM FILLED ADHESIVE TAPE.
 - WIDTH FOR 1 WAY, 2 WAY, 3 WAY AND 6 WAY CONNECTORS, FOR LENGTH SEE TABLE.
 - USED TO ADHERE A 9286 CONNECTOR TO A FLAT SURFACE.
 - SOME SURFACES MAY REQUIRE THE USE OF A CLEANING SOLVENT TO ACHIEVE BEST RESULTS.
 - SUPPLIED CUT TO SIZE ON A REEL ON AN OVERSIZE BACKING STRIP PARTS 400 PER REEL.

FORM-106-01-056-6 ISS 7

ELCO EUROPE (A DIVISION OF AVX LTD.) CONFIDENTIAL PROPRIETY
 THE DRAWING ON THIS PRINT AND INFORMATION THEREWITH ARE PROPRIETARY TO ELCO EUROPE (A DIVISION OF AVX LTD.) AND SHALL NOT BE USED OR DISCLOSED IN WHOLE OR IN PART WITHOUT ELCO EUROPE'S WRITTEN CONSENT.

SHEET 9 OF 9

Release No. 102717	History 11.11.2011 30.11.2011 08.02.2012 20.06.2012
-----------------------	---

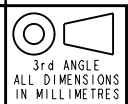

Drawn N.C.H.	Description POKE HOME CONNECTOR - THRU WIRE	DATE 08-Nov-11
Size CV	Part Number 00-9286-01_000S	Issue 1

A

B