



Obsolescence Notice

This product is obsolete.

This information is available for your convenience only.

For more information on Zarlink's obsolete products and replacement product lists, please visit http://products.zarlink.com/obsolete_products/

Features

April 2003

- High Output Drive
 - 18.8 Vpp differential output voltage, RL = 50Ω
 - 9.4 Vpp single-ended output voltage, RL = 25Ω
- High Output Current
 - ± 200mA @ Vo = 9.4 Vpp, Vs = 12V
- Low Distortion
 - 85dB SFDR (Spurious Free Dynamic Range) @ 100KHz, Vo = 2Vpp, RL = 25Ω
- High Speed
 - 192MHz 3dB bandwidth (G=2)
 - 240V / μs slew rate
- Low Noise
 - 3.8nV / √Hz: input noise voltage
 - 2.7pA / √Hz: input noise current
- Low supply current: 7mA/amp
 - Single-supply operation: 5V to 12V
- High ESD (Electro-Static Discharge) immunity
 - 4kV for Supply and Output pins
- Low differential gain and phase
 - 0.005% and -0.07deg

Ordering Information

ZL40166/DCA (tubes) 8 lead SOIC
 ZL40166/DCB (tape and reel) 8 lead SOIC
-40°C to +85°C

Description

The ZL40166 is a low cost voltage feedback opamp capable of driving signals to within 1V of the power supply rails. It features low noise and low distortion accompanied by a high output current which makes it ideally suited for the application as an xDSL line driver. The dual opamp can be connected as a differential line driver delivering signals up to 18.8Vpp swing into a 25 Ω load, fully supporting the peak upstream power levels for upstream full-rate ADSL (Asymmetrical Digital Subscriber Line).

The wide bandwidth, high power output and low differential gain and phase figures make the ZL40166 ideally suited for a wide variety of video driver applications.

Applications

- ADSL PCI modem cards
- xDSL external modem
- Line Driver

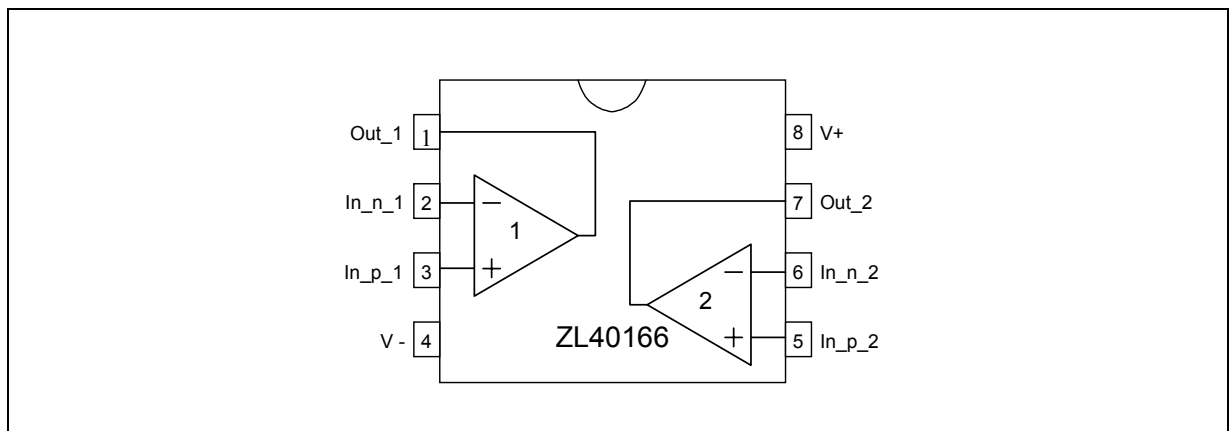
Figure 1 - Functional Block Diagram and Pin Connection

Application Notes

The ZL40166 is a high speed, high output current, dual operational amplifier with a high slew rate and low distortion. The device uses conventional voltage feedback for ease of use and more flexibility. These characteristics make the ZL40166 ideal for applications where driving low impedances of 25 to 100Ω such as xDSL and active filters.

The figure below shows a typical ADSL application utilising a 1:2 transformer, the feedback path provides a Gain = +2.

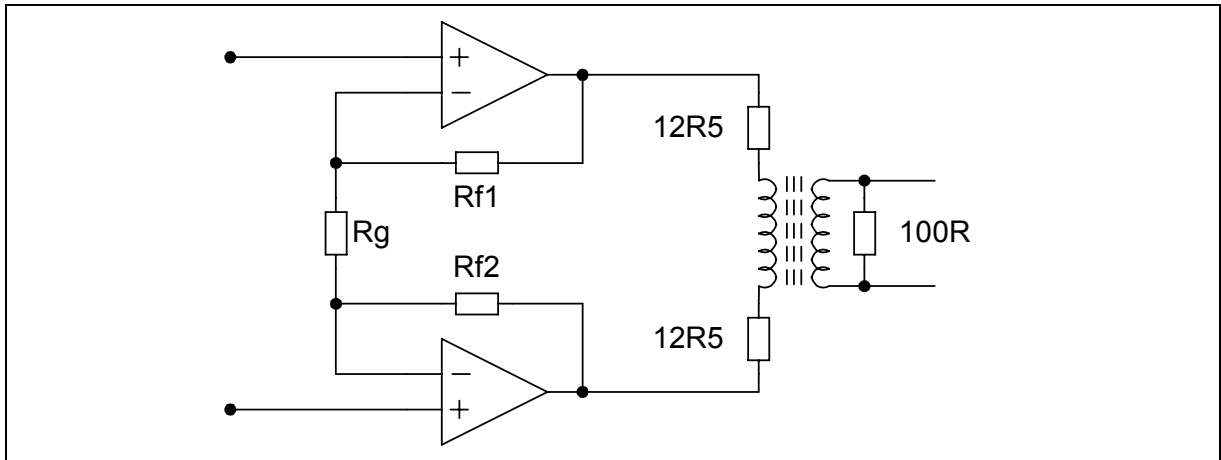

Figure 2 - A Typical ADSL Application

A class AB output stage allows the ZL40166 to deliver high currents to low impedance loads with low distortion while consuming low quiescent current.

Note: the high ESD immunity figure of 4kV may mean that in some designs fewer additional EMC protection components are needed thus reducing total system costs.

The ZL40166 is not limited to ADSL applications and can be used as a general purpose opamp configured with either inverting or non-inverting feedback. The figure below shows non-inverting feedback arrangement that has typically been used to obtain the data sheet specifications.

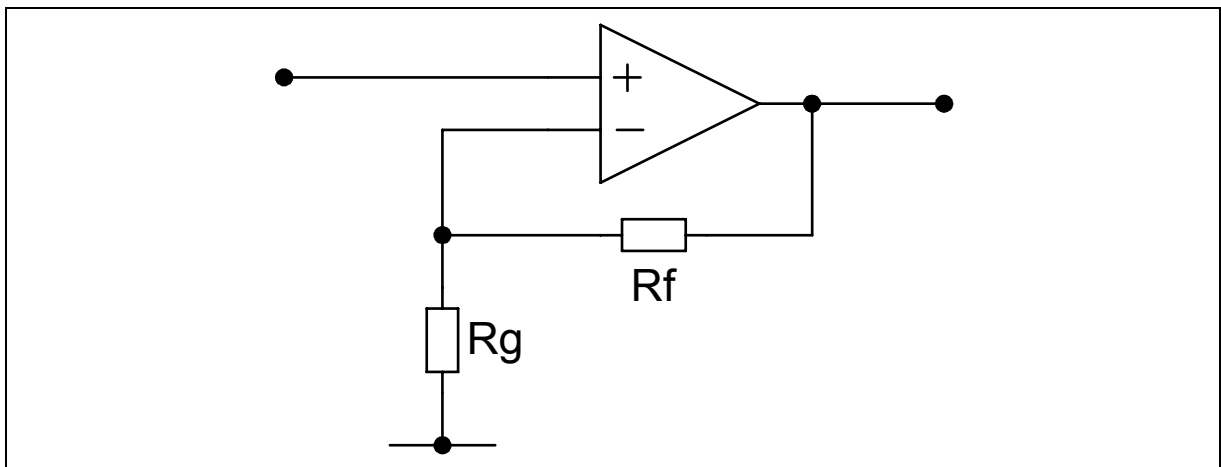

Figure 3 - A Non-Inverting Feedback Amplifier Example

Video transmitter and receiver for twisted wire pair.

Composite video signals can be transmitted down twisted pair cable, i.e. Ethernet (CAT 5), using a differential transmitter and receiver. The transmitter must be able to drive high currents into the low impedance twisted pair cable. For video, the amplifiers require flat gain and low phase-shift over the video signal band. To ensure this, the amplifiers will have 3dB bandwidths well in excess of this. The ZL40166 (dual amplifier) has all of these attributes.

With reference to the differential video driver shown in Figure , the input coax is assumed to have a characteristic impedance of 75 Ohms, this is terminated with a parallel combination of 110 Ohms and the input impedance of amplifier IC1 (b) of 255 Ohms, giving 77 Ohms. Low values of feedback resistors are used around the op-amps to reduce phase-shift due to parasitic capacitors and to minimise the addition of noise.

Baseband PAL or NTSC video signals generally have an amplitude of 2V pk-pk. A gain of two is used to ensure that the signal level at the end of the (terminated with 100 Ohms) differential pair will be the same as the input level, neglecting any losses due to the use of long cable lengths.

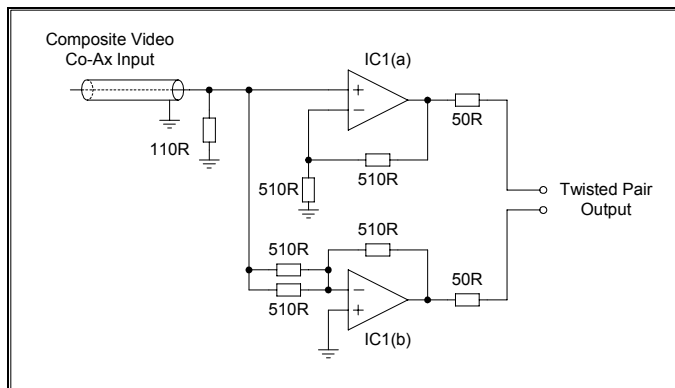

Figure 4 - Differential Video Driver

The differential receiver is shown in Figure 5 has a 100 Ohm line termination resistor, followed by a differential amplifier. Long cables will tend to attenuate the signal with greater losses at the higher frequencies, so the second amplifier is used to equalise these losses. Initially the amplifier should be built without fitting components R1 and C1. Select the value of R2 to give the required gain at low frequency. Adjust the values of R1 and C1 to correct for the frequency dependant attenuation of the cable.

To drive a coax cable the output of the amplifier is connected via a series matching 75 Ohm resistor, again this second (dual amplifier) ZL40166 provides the required power output for the restored 2Vpk-pk video signal.

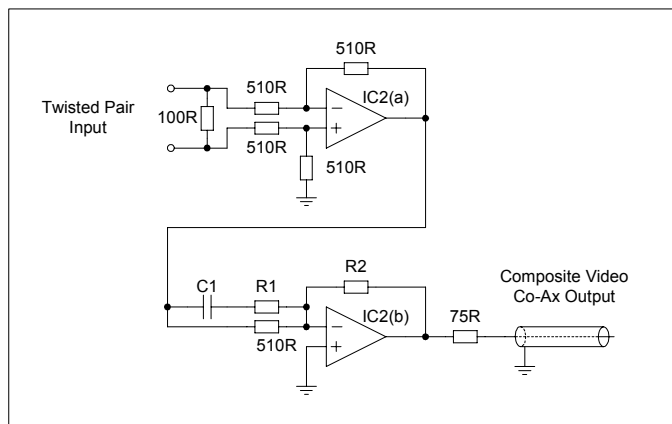

Figure 5 - Differential Video Receiver

Absolute Maximum Ratings - (See Note 1)

Parameter	Symbol	Min	Max	Units
Vin Differential	V_{IN}		±1.2	V
Output Short Circuit Protection	$V_{OS/C}$		See Apps Note in this data sheet	
Supply Voltage	V+, V-		±13.2	V
Voltage at Input Pins	$V_{(+IN)}, V_{(-IN)}$	(V-) -0.8	(V+) +0.8	V
Voltage at Output Pins	V_O		±5.5	V
ESD Protection (HBM Human Body Model) (See Note 2)		4	(Note 3)	kV
Storage Temperature		-55	+150	°C
Latch-up test		+/-100mA for 100ms	(Note 4)	
Supply transient test		20% pulse for 100ms	(Note 5)	

Note 1: Absolute Maximum Ratings indicate limits beyond which damage to the device may occur. Operating Ratings indicate conditions for which the device is intended to be functional, but specific performance is not guaranteed. For guaranteed specifications and the test conditions, see the Electrical Characteristics.

Note 2: Human body model, 1.5kΩ in series with 100pF. Machine model, 200Ω in series with 100pF.

Note 3: 1.25kV between the pairs of +INA, -INA and +INB, -INB pins only. 4kV between supply pins, OUTA or OUTB pins and any input pin.

Note 4: +/-100mA applied to input and output pins to force the device to go into "latch-up". The device passes this test to JEDEC spec 17.

Note 5: Positive and Negative supply transient testing increases the supplies by 20% for 100ms.

Operating Ratings - (See Note 1)

Parameter	Symbol	Min	Max	Units
Supply Voltage	V+, V-	± 2.5	±6.5	V
Junction Temperature Range		-40	150	°C
Junction to Ambient Resistance	Rth(j-a)	150		°C 4 layer FR5 board
Junction to Case Resistance	Rth(j-c)	60		°C 4 layer FR5 board

Note 1: Absolute Maximum Ratings indicate limits beyond which damage to the device may occur. Operating Ratings indicate conditions for which the device is intended to be functional, but specific performance is not guaranteed. For guaranteed specifications and the test conditions, see the Electrical Characteristics.

Electrical Characteristics - TA = 25°C, G = +2, Vs = ± 6V, Rf = Rg = 510Ω, RL = 100Ω / 2pF; Unless otherwise specified.

Symbol	Parameter	Conditions	Min (Note 1)	Typ (Note 2)	Max (Note 3)	Units	Test Type
Dynamic Performance							
	-3dB Bandwidth	Vo = 200mVp-p		192		MHz	C
	-0.1dB Bandwidth	Vo = 200mVp-p		32		MHz	C
	Slew Rate	4V Step O/P, 10-90%		240		V/μs	C
	Rise and Fall Time	4V Step O/P, 10-90%		13.3		ns	C
	Rise and Fall Time	200mV Step O/P, 10-90%		1.7		ns	C
	Differential Gain	NTSC, RL = 150Ω		0.005		%	C
	Differential Phase	NTSC, RL = 150Ω		-0.07		deg	C
Distortion and Noise Response							
	2 nd Harmonic Distortion	Vo = 8.4Vpp, f = 100KHz, RL = 25Ω/2pF		-65.4		dBc	C
		Vo = 8.4Vpp, f = 1MHz, RL = 100Ω/2pF		-83.8		dBc	C
		Vo = 2Vpp, f = 100kHz, RL = 25Ω/2pF		-93.6		dBc	C
		Vo = 2Vpp, f = 1MHz, RL = 100Ω/2pF		-86		dBc	C
	3 rd Harmonic Distortion	Vo = 8.4Vpp, f = 100KHz, RL = 25Ω/2pF		-70		dBc	C
		Vo = 8.4Vpp, f = 1MHz, RL = 100Ω/2pF		-77.7		dBc	C
		Vo = 2Vpp, f = 100KHz, RL = 25Ω/2pF		-85		dBc	C
		Vo = 2Vpp, f = 1MHz, RL = 100Ω/2pF		-73.5		dBc	C
MTPR	Multi-Tone Power Ratio	47.4375 KHz		-75		dBc	C
		69 KHz		-76.3		dBc	C
		90.5625 KHz		-73.8		dBc	C
		112.125 KHz		-71.5		dBc	C
	Input Noise Voltage	f = 100KHz		3.85		nV/√Hz	C
	Input Noise Current	f = 100KHz		2.7		pA/√Hz	C
Input Characteristics							
Vos	Input Offset Voltage	Tj = -40°C to 150°C	- 4.2	- 0.3	4.2	mV	A

Symbol	Parameter	Conditions	Min (Note 1)	Typ (Note 2)	Max (Note 3)	Units	Test Type
I _b	Input Bias Current	T _j = -40°C to 150°C		-10	-20	μA	A
I _{os}	Input Offset Current	T _j = -40°C to 150°C	-2	-0.2	2	μA	A
CMVR	Common Mode Voltage Range	T _j = -40°C to 150°C	- 4.9		4.9	V	A
CMRR	Common Mode Rejection Ratio	T _j = -40°C to 150°C	70	79		dB	A
Transfer Characteristics							
A _{vol}	Voltage Gain	RL = 1k, T _j = -40°C to 150°C	4.7	10		V/mV	A
		RL = 25Ω, T _j = -40°C to 150°C	1.6	5.5			A
	Output Swing	RL = 25Ω, T _j = -40°C to 150°C	- 4.5	± 4.7	4.5	V	A
	Output Swing	RL = 1k, T _j = -40°C to 150°C	- 5	± 5.1	5	V	A
I _{sc}	Output Current (Note 3)	V _o = 0, T _j = -40°C to 150°C	570	1000		mA	B
Power Supply							
I _s	Supply Current / Amp	T _j = -40°C to 150°C		7	9	mA	A
PSRR	Power Supply Rejection Ratio	T _j = -40°C to 150°C	73	81		dB	A

Note 1: The maximum power dissipation is a function of T_j(max), θ_{JA} and T_A. The maximum allowable power dissipation at any ambient temperature is PD = (T_j(max) - T_A) / θ_{JA}. All numbers apply for packages soldered directly onto a PC board.

Note 2: Typical values represent the most likely parametric norm.

Note 3: Test Types:

- 100% tested at 25°C. Over temperature limits are set by characterisation, simulation and statistical analysis.
- Limits set by characterisation, simulation and statistical analysis.
- Typical value only for information.

± 2.5V Electrical Characteristics - TA = 25°C, G = +2, Vs = ± 2.5V, Rf = Rg = 510Ω, RL = 100Ω / 2pF; Unless otherwise specified.

Symbol	Parameter	Conditions	Min (Note 1)	Typ (Note 2)	Max (Note 3)	Units	Test Type
Dynamic Performance							
	-3dB Bandwidth			176.5		MHz	C
	-0.1dB Bandwidth			83.8		MHz	C
	Slew Rate	1V Step O/P, 10-90%		216		V/μs	C
	Rise and Fall Time	1V Step O/P, 10-90%		3.7		ns	C
	Rise and Fall Time	200mV Step O/P, 10-90%		1.7		ns	C
Distortion and Noise Response							
	2 nd Harmonic Distortion	Vo = 2Vpp, f = 100KHz, RL = 25Ω		-92.6		dBc	C
		Vo = 2Vpp, f = 1MHz, RL = 100Ω		-85		dBc	C
	3 rd Harmonic Distortion	Vo = 2Vpp, f = 100KHz, RL = 25Ω		-86.3		dBc	C
		Vo = 2Vpp, f = 1MHz, RL = 100Ω		-74.8		dBc	C
Input Characteristics							
Vos	Input Offset Voltage	Tj = -40°C to 150°C	- 4.2	- 0.3	4.2	mV	B
Ib	Input Bias Current	Tj = -40°C to 150°C		- 10	-20	μA	B
CMVR	Common Mode Voltage Range		-1.55		1.55	V	B
CMRR	Common Mode Rejection Ratio	Tj = -40°C to 150°C	70	80		dB	B
Transfer Characteristics							
Avol	Voltage Gain	RL = 1k, Tj = -40°C to 150°C	5.5	10.5		V/mV	B
		RL = 25Ω, Tj = -40°C to 150°C	1.6	5.8			B
Output Characteristics							
	Output Swing	RL = 25Ω, Tj = -40°C to 150°C	-1.4	±1.45	1.4	V	B
		RL = 1k, Tj = -40°C to 150°C	-1.6	±1.65	1.6		B

Symbol	Parameter	Conditions	Min (Note 1)	Typ (Note 2)	Max (Note 3)	Units	Test Type
Power Supply							
Is	Supply Current/Amp	Tj = -40°C to 150°C		6.75	8.5	mA	A
PSRR	Power Supply Rejection Ratio	Tj = -40°C to 150°C	73	83		dB	B

Note 1: The maximum power dissipation is a function of $T_j(\text{max})$, θ_{JA} and T_A . The maximum allowable power dissipation at any ambient temperature is $PD = (T_j(\text{max}) - T_A) / \theta_{JA}$. All numbers apply for packages soldered directly onto a PC board.

Note 2: Typical values represent the most likely parametric norm.

Note 3: Test Types:

- a. 100% tested at 25°C. Over temperature limits are set by characterisation, simulation and statistical analysis.
- b. Limits set by characterisation, simulation and statistical analysis.
- c. Typical value only for information.

Typical Performance Characteristics At TA = 25°C, RF = RG = 510, gain = +2, RL = 100, Vs = 6V. Unless otherwise specified.

Output Swing

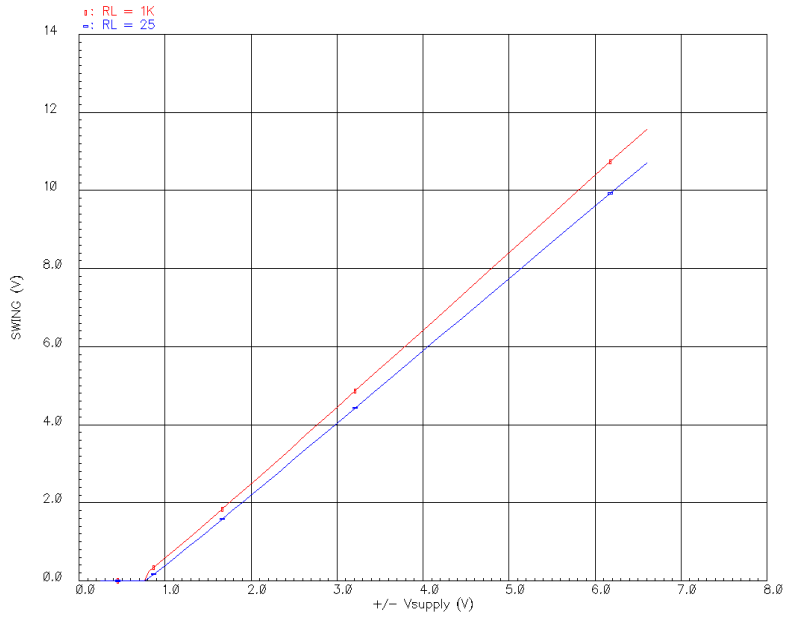

Positive Output Swing into 1kΩ

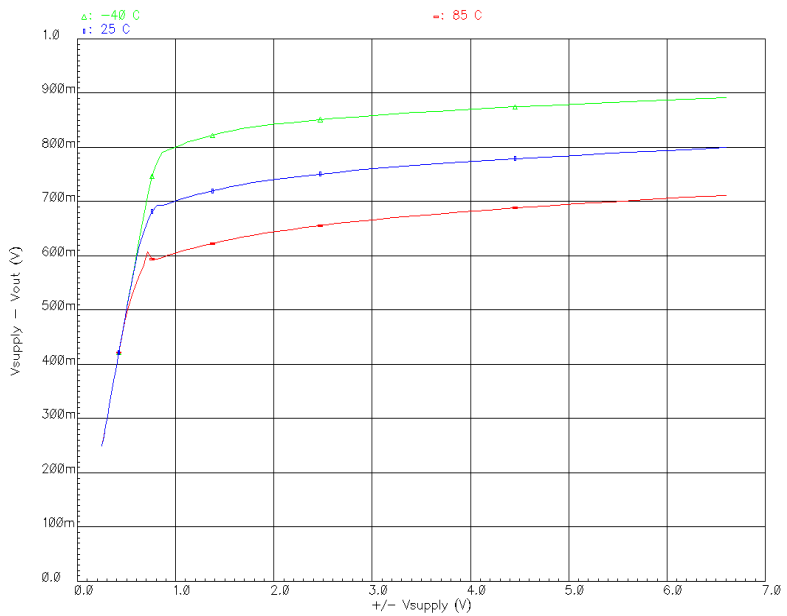

Typical Performance Characteristics At TA = 25°C, RF = RG = 510, gain = +2, RL = 100, Vs = 6V. Unless otherwise specified.

Negative Output Swing into 1kΩ

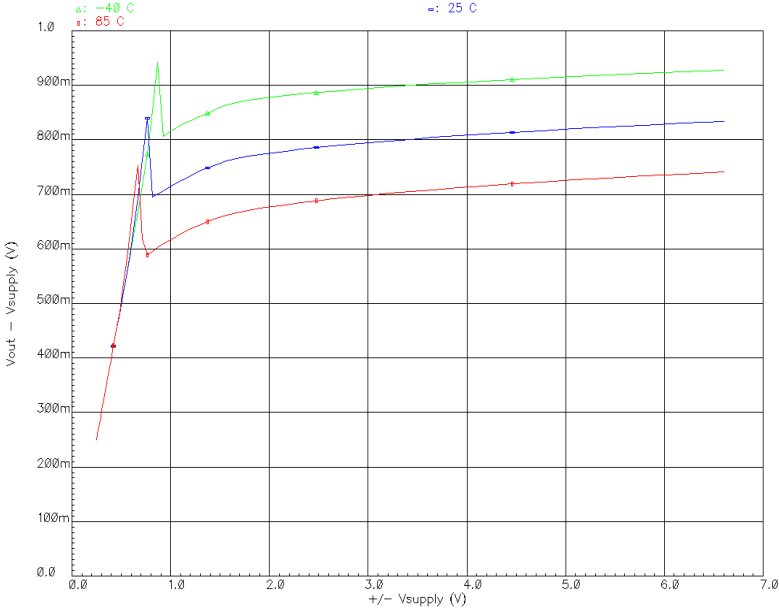

Positive Output Swing into 25Ω

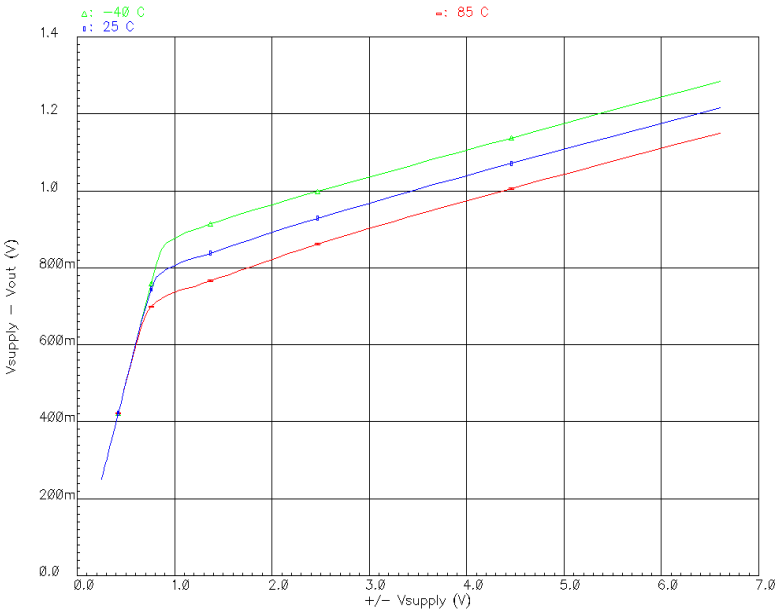

Typical Performance Characteristics At TA = 25°C, RF = RG = 510, gain = +2, RL = 100, Vs = 6V. Unless otherwise specified.

Negative Output Swing into 25Ω

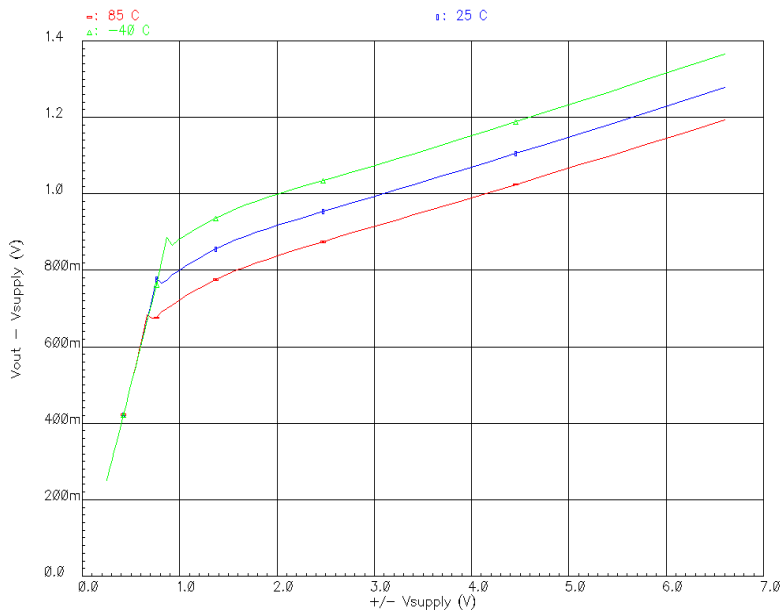

+Vout VS Iload

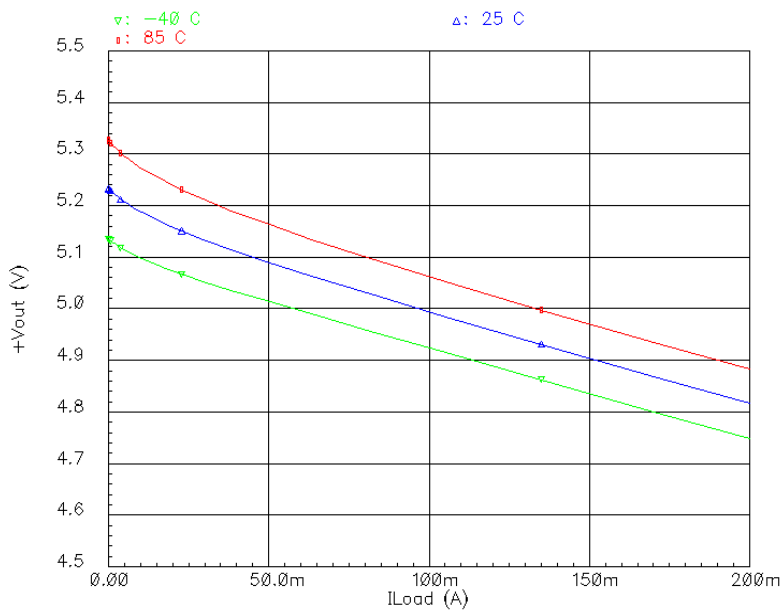

Typical Performance Characteristics At TA = 25°C, RF = RG = 510, gain = +2, RL = 100, Vs = 6V. Unless otherwise specified.

-Vout VS ILoad

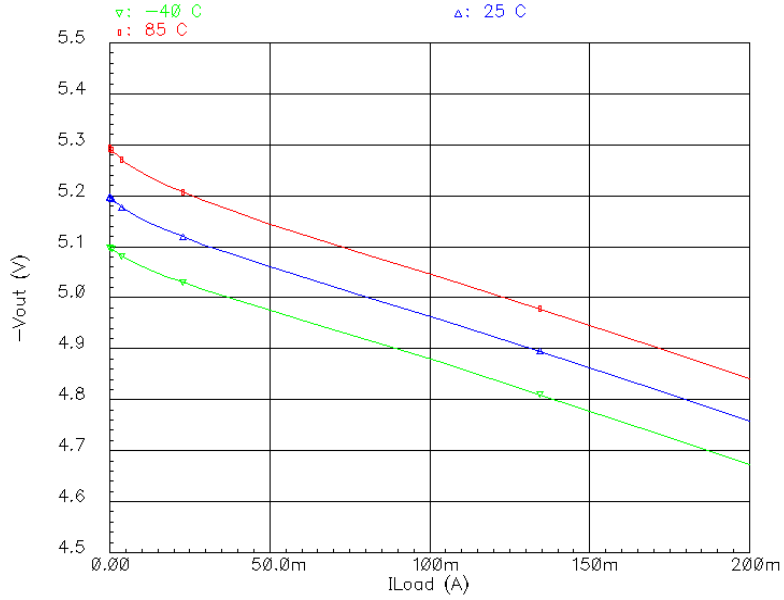

+Vout VS ILoad, Vs = ±2.5V

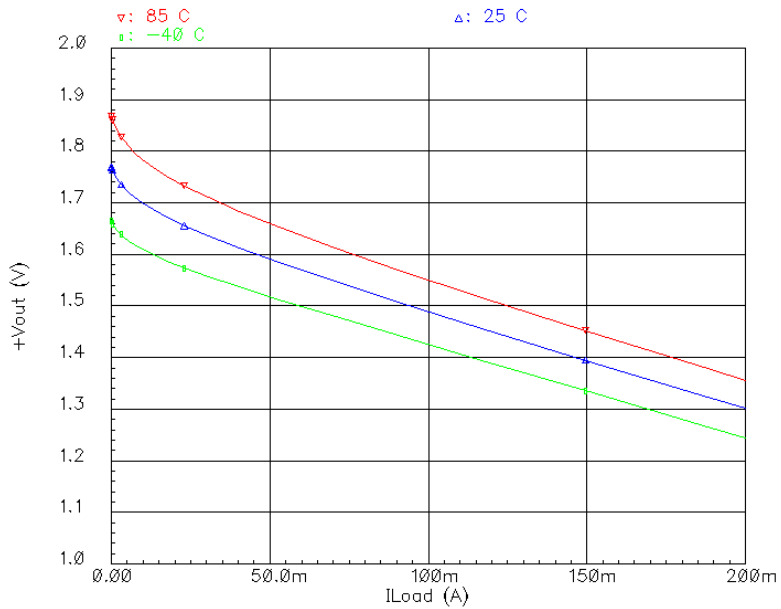

Typical Performance Characteristics At TA = 25°C, RF = RG = 510, gain = +2, RL = 100, Vs = 6V. Unless otherwise specified.

-Vout VS ILoad, Vs = ±2.5V

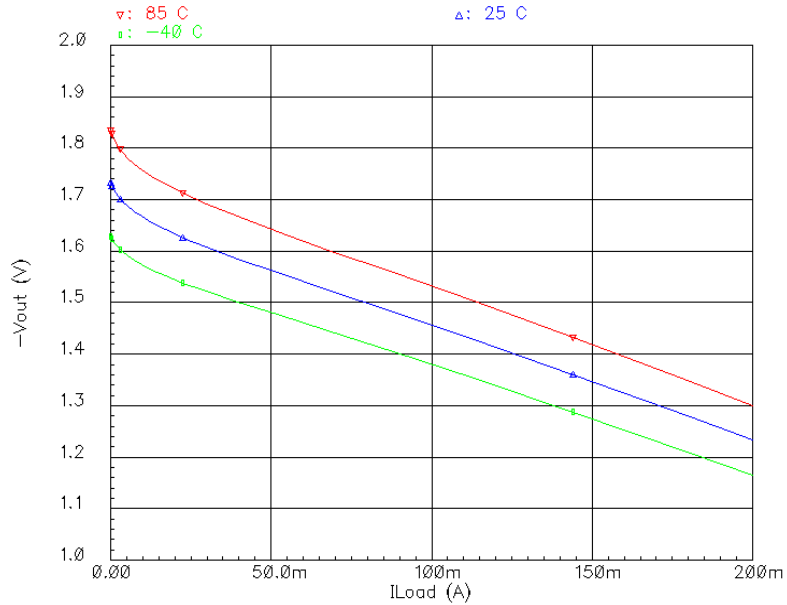

Supply Current VS. Supply Voltage

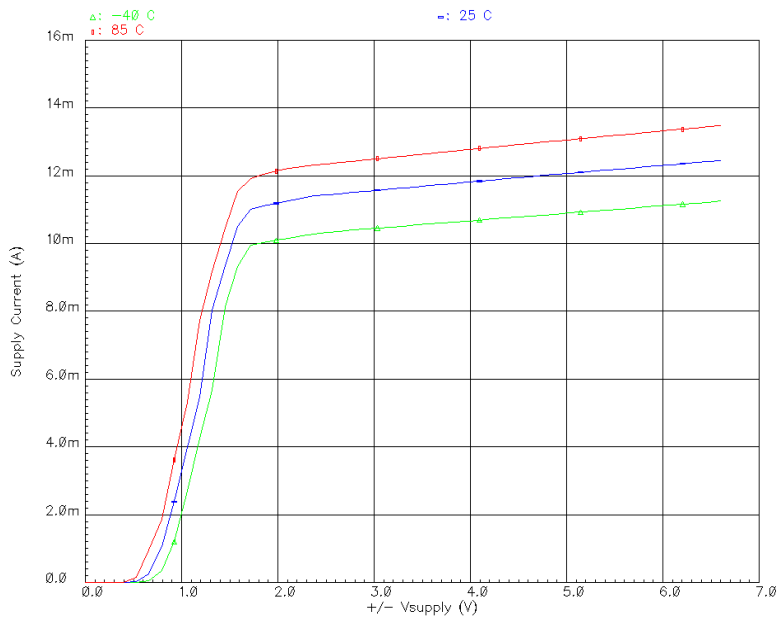

Typical Performance Characteristics At TA = 25°C, RF = RG = 510, gain = +2, RL = 100, Vs = 6V. Unless otherwise specified.

Sourcing Current VS. Supply Voltage

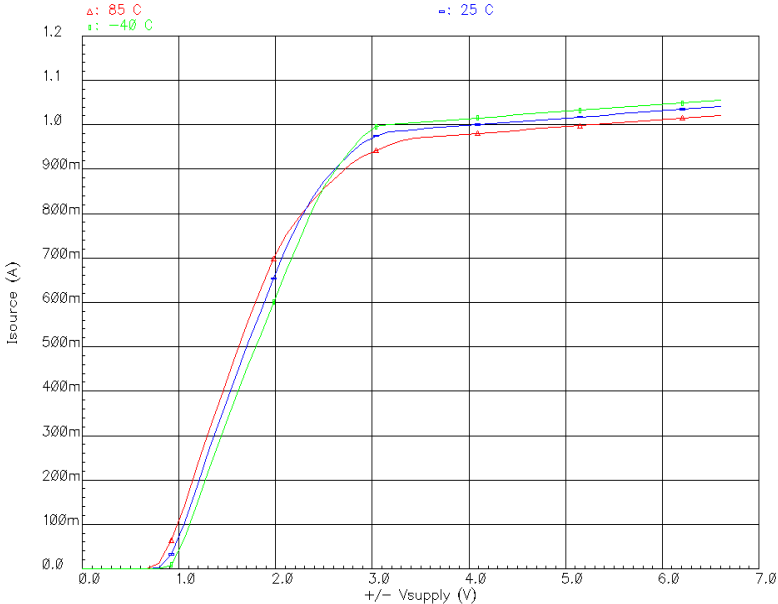

Sinking Current VS. Supply Voltage

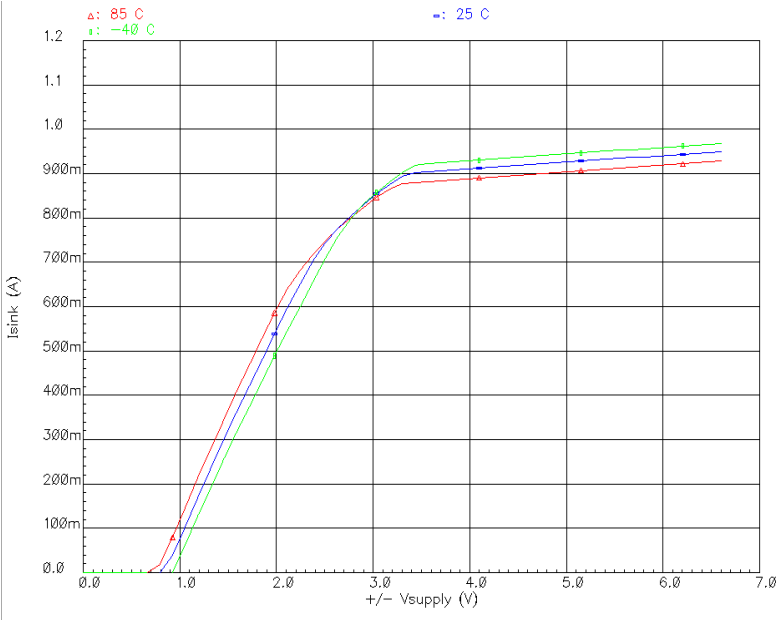

Typical Performance Characteristics At TA = 25°C, RF = RG = 510, gain = +2, RL = 100, Vs = 6V. Unless otherwise specified.

Vos VS. Vs

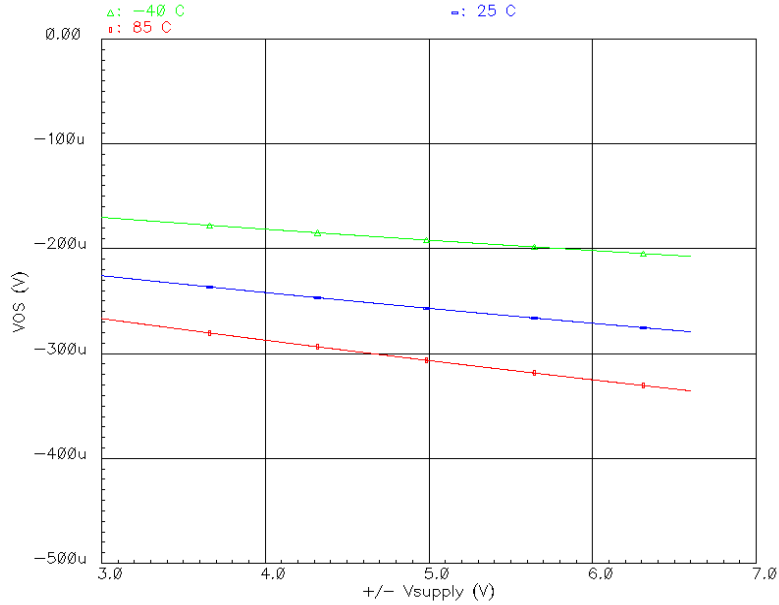

Vos VS. Vcm

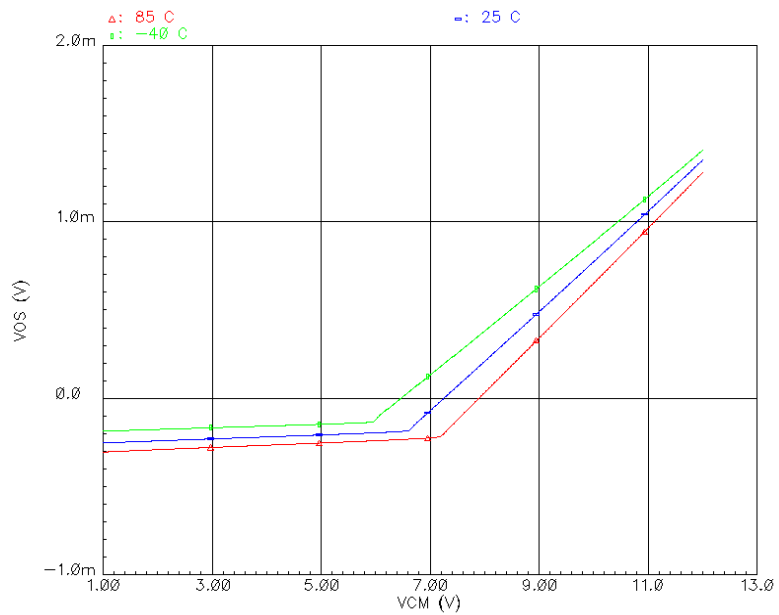

Typical Performance Characteristics At TA = 25°C, RF = RG = 510, gain = +2, RL = 100, Vs = 6V. Unless otherwise specified.

Vos VS. Vcm, Vs = ±2.5V

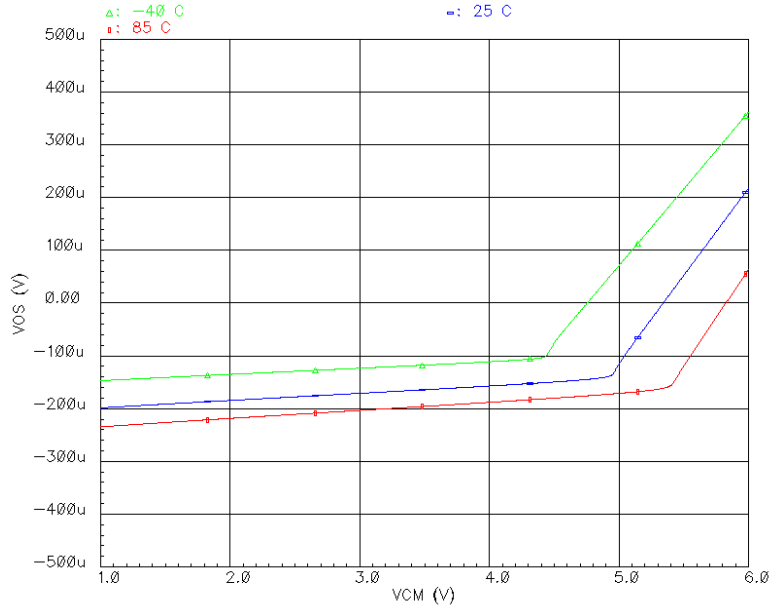

Bias Current VS. Vsupply

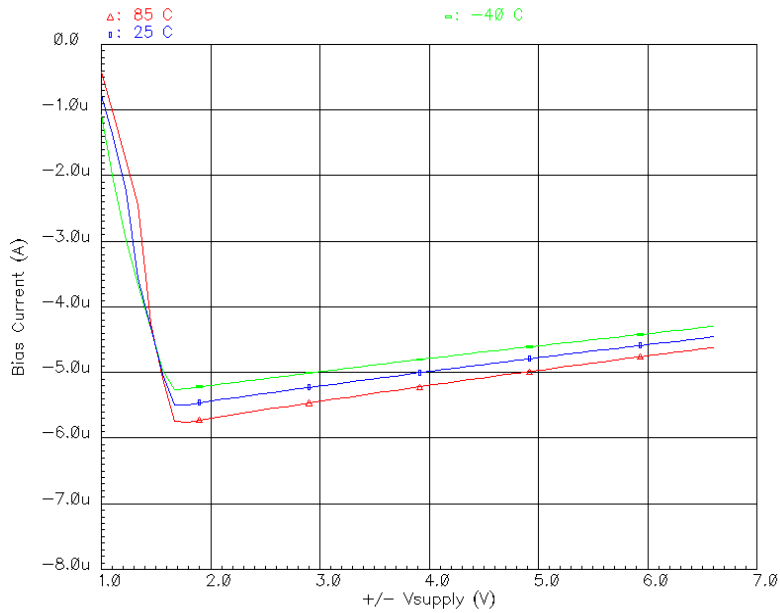

Typical Performance Characteristics At TA = 25°C, RF = RG = 510, gain = +2, RL = 100, Vs = 6V. Unless otherwise specified.

Offset Current VS. Vsupply

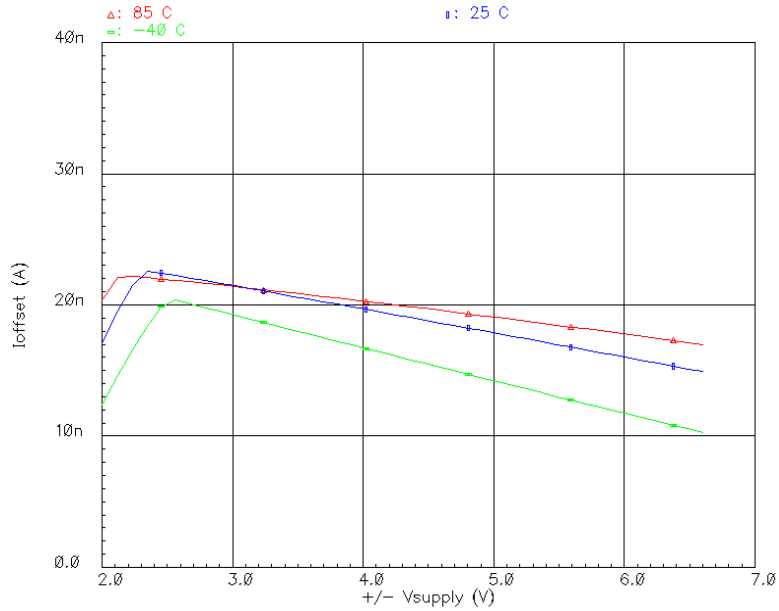

Harmonic Distortion VS. Load
F = 1MHZ Vout = 2Vpp

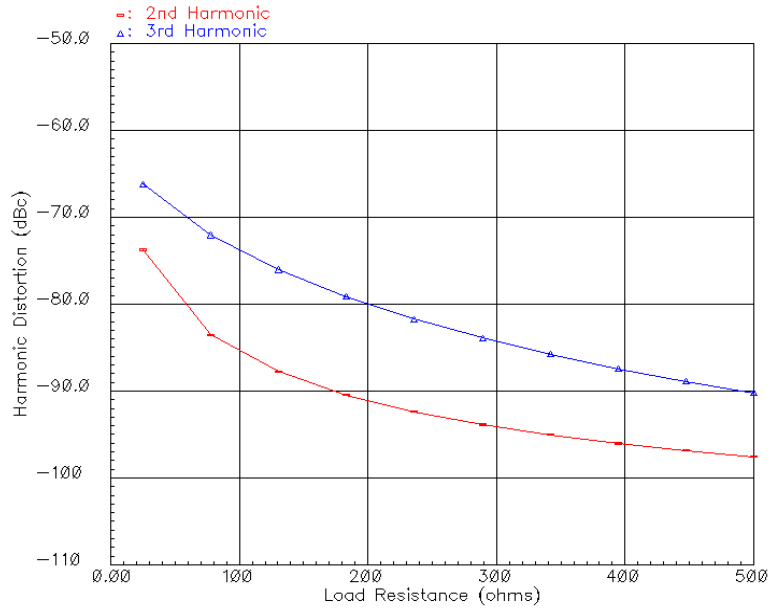

Typical Performance Characteristics At TA = 25°C, RF = RG = 510, gain = +2, RL = 100, Vs = 6V. Unless otherwise specified.

Harmonic Distortion VS. Load
 Vs = ±2.5V, F = 1MHz, Vout = 2Vpp

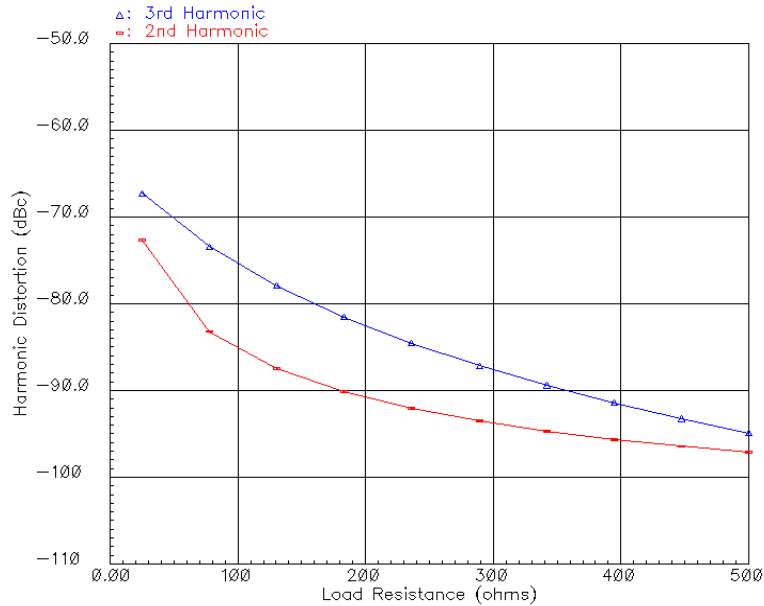

Harmonic Distortion VS. Output Voltage
 Vs = ±2.5V, F = 1MHz

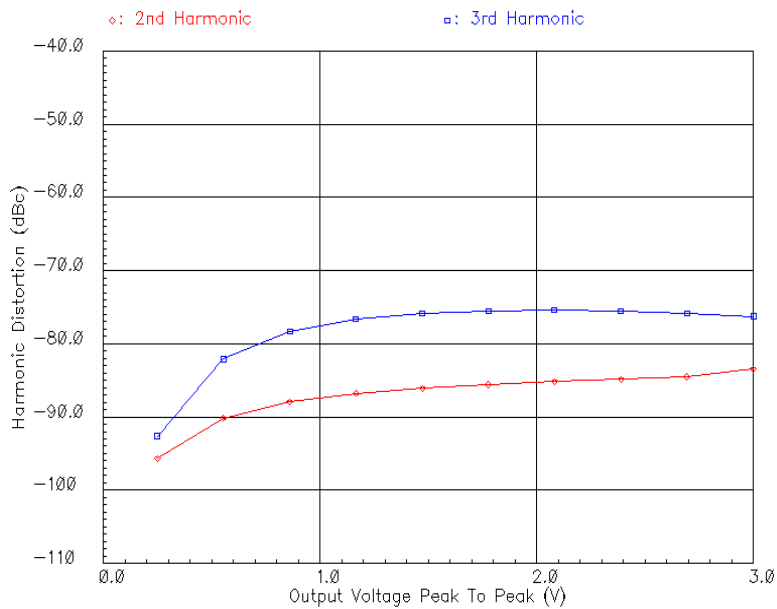

Typical Performance Characteristics At TA = 25°C, RF = RG = 510, gain = +2, RL = 100, Vs = 6V. Unless otherwise specified.

Harmonic Distortion VS. Output Voltage
F = 1MHz

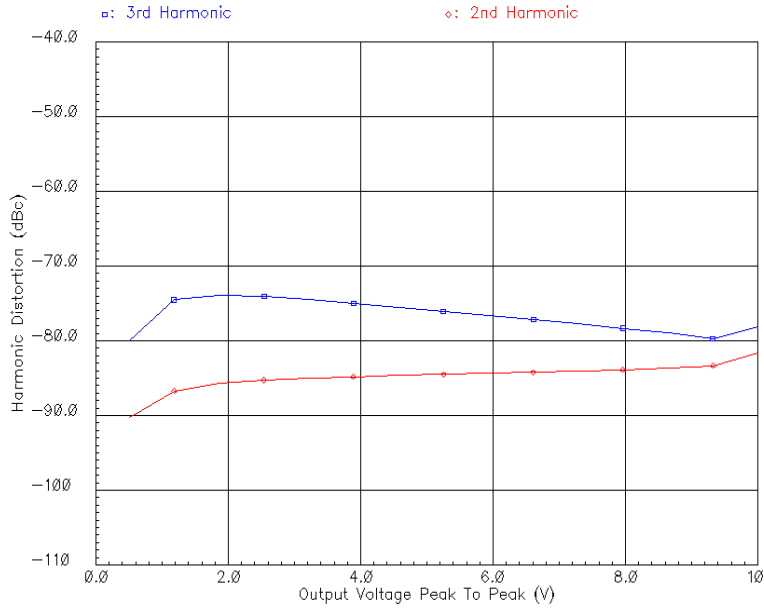

Harmonic Distortion VS. Output Voltage
Vs = ±2.5V, F = 1MHz, RL = 25Ω

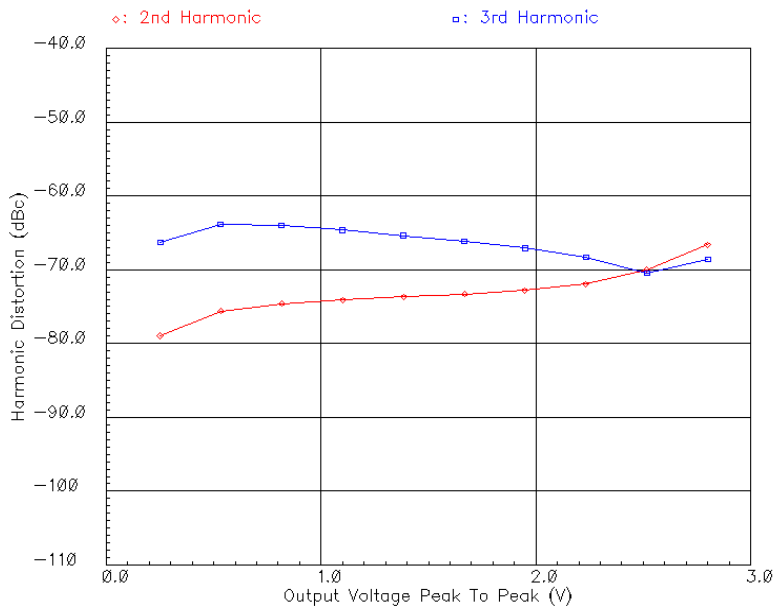

Typical Performance Characteristics At TA = 25°C, RF = RG = 510, gain = +2, RL = 100, Vs = 6V. Unless otherwise specified.

Harmonic Distortion VS. Output Voltage
F = 1MHz, RL = 25Ω

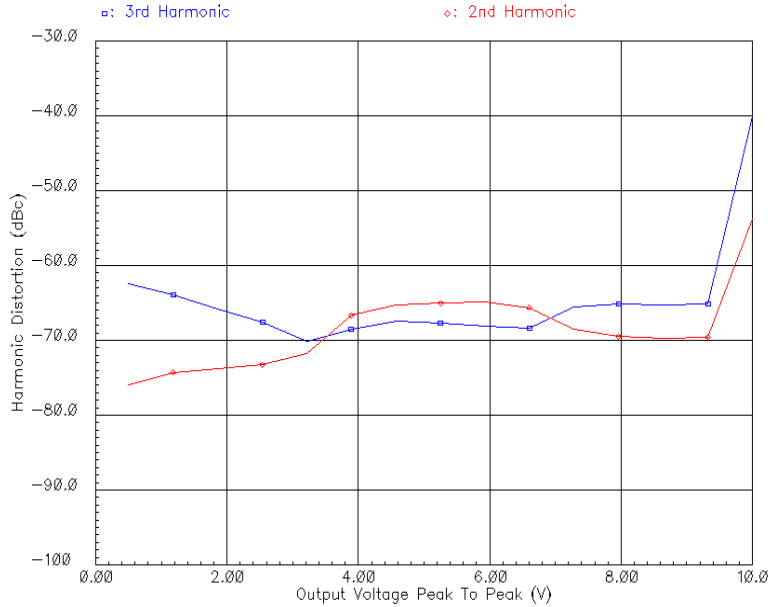

Harmonic Distortion VS. Output Voltage
F = 10MHz

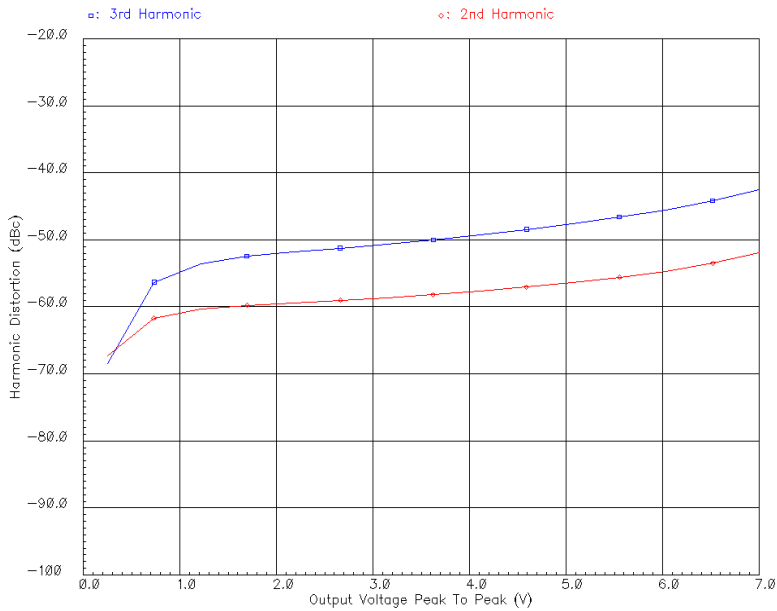

Typical Performance Characteristics At TA = 25°C, RF = RG = 510, gain = +2, RL = 100, Vs = 6V. Unless otherwise specified.

Harmonic Distortion VS. Output Voltage
F = 10MHz, RL = 25Ω

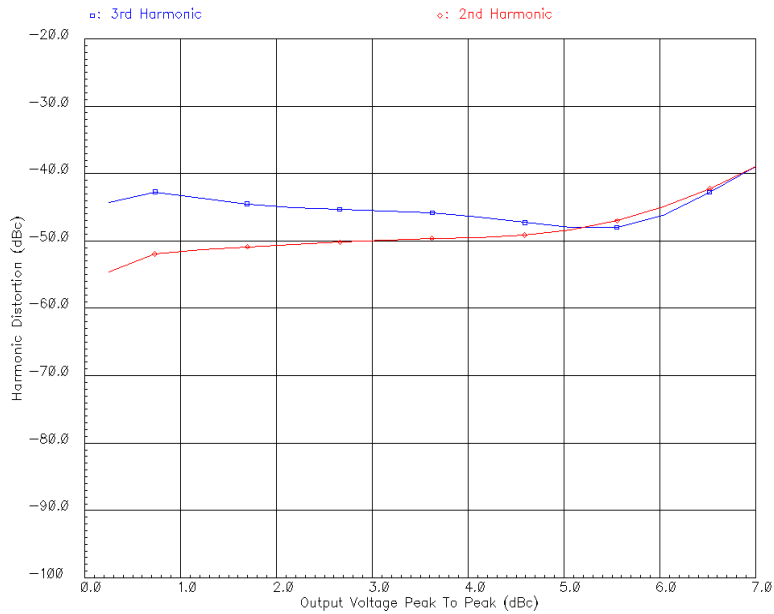

Harmonic Distortion VS. Frequency
Vout = 2Vpp

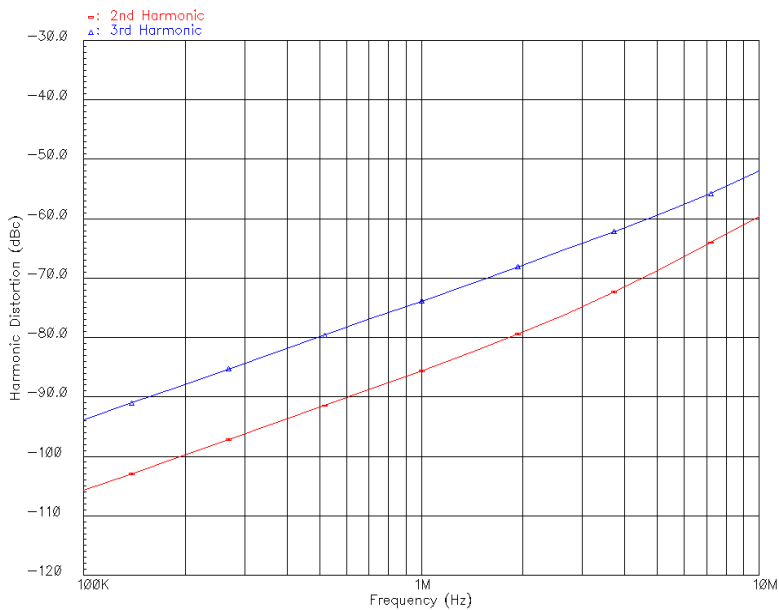

Typical Performance Characteristics At TA = 25°C, RF = RG = 510, gain = +2, RL = 100, Vs = 6V. Unless otherwise specified.

Harmonic Distortion VS. Output Voltage
Vs = ±2.5V, F = 10MHz

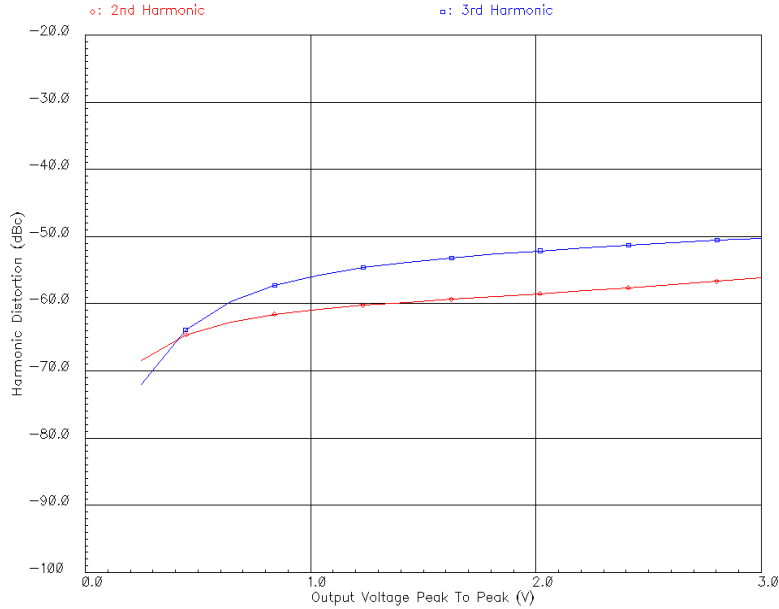

Harmonic Distortion VS. Frequency
Vout = 2Vpp, RL = 25Ω

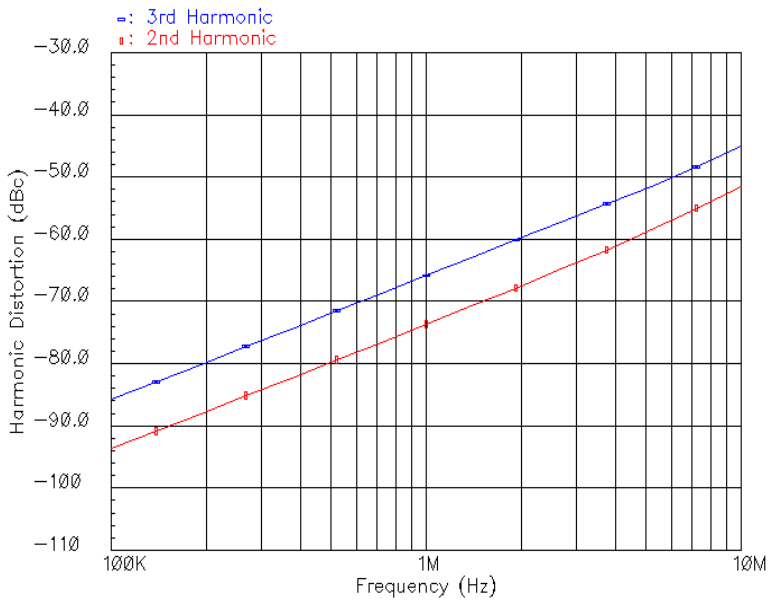

Typical Performance Characteristics At TA = 25°C, RF = RG = 510, gain = +2, RL = 100, Vs = 6V. Unless otherwise specified.

Harmonic Distortion VS. Output Voltage
 Vs = ±2.5V, F = 10MHz, RL = 25Ω

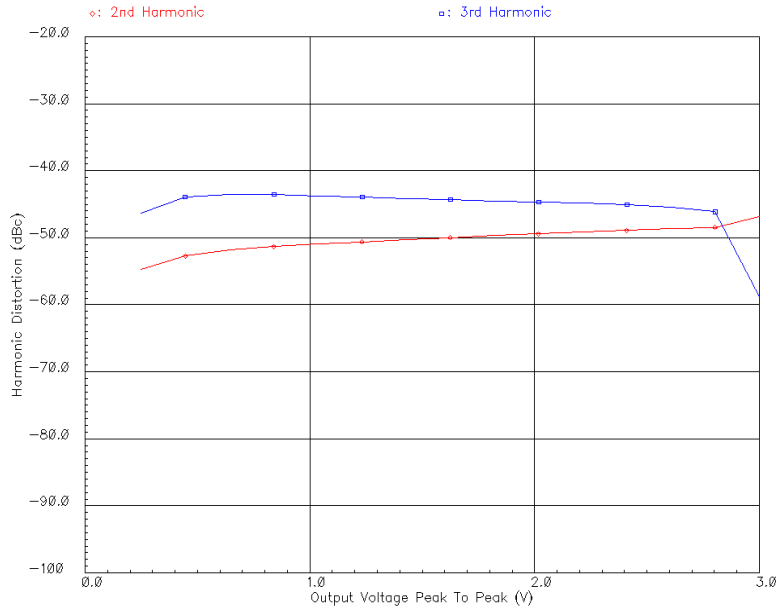

Harmonic Distortion VS. Frequency
 Vout = 2Vpp, Vs = ±2.5V

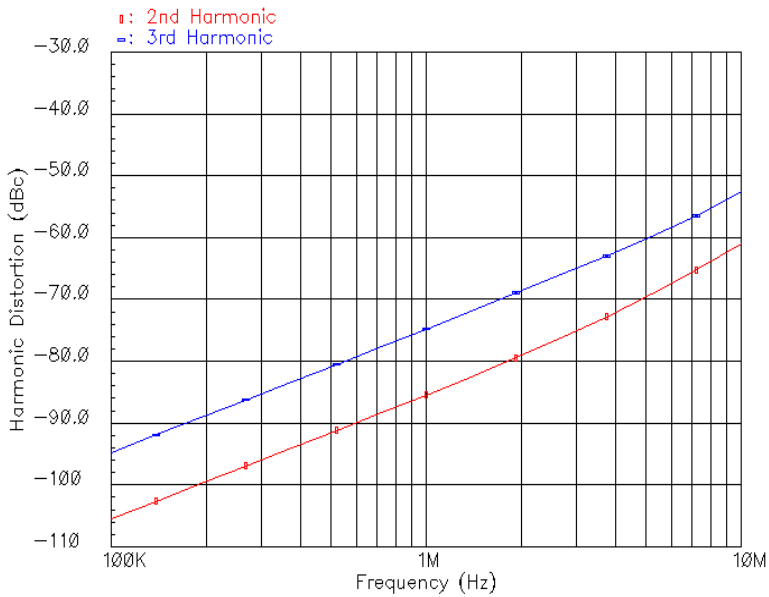

Typical Performance Characteristics At TA = 25°C, RF = RG = 510, gain = +2, RL = 100, Vs = 6V. Unless otherwise specified.

Harmonic Distortion VS. Frequency

Vout = 2Vpp, Vs = ±2.5V, RL = 25Ω

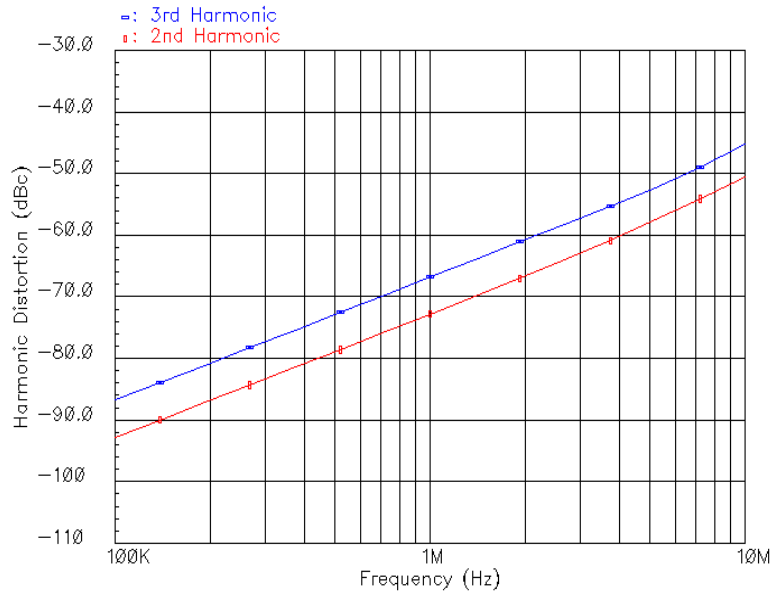

Frequency Response

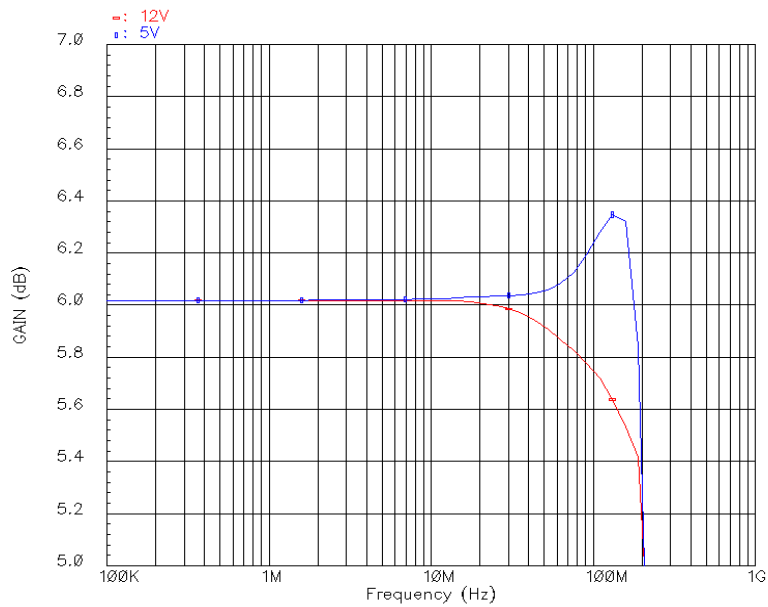

Typical Performance Characteristics At TA = 25°C, RF = RG = 510, gain = +2, RL = 100, Vs = 6V. Unless otherwise specified.

Pulse Response

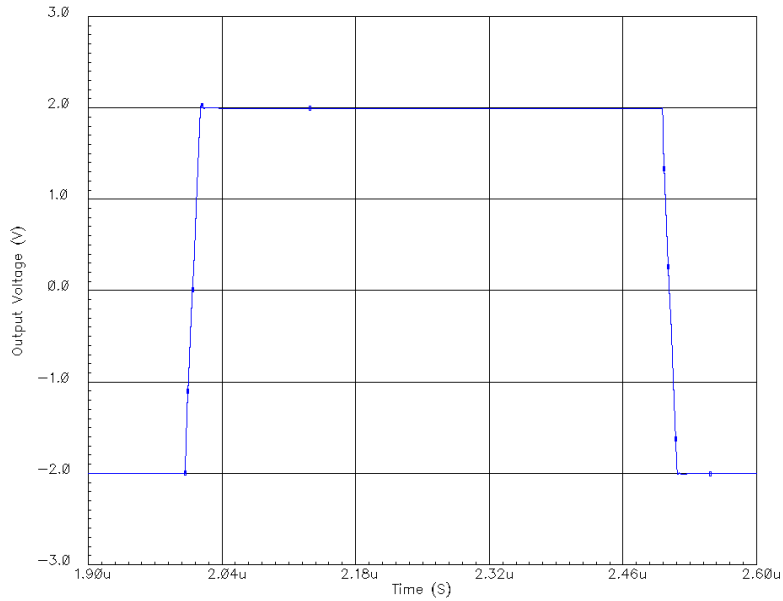

Frequency Response

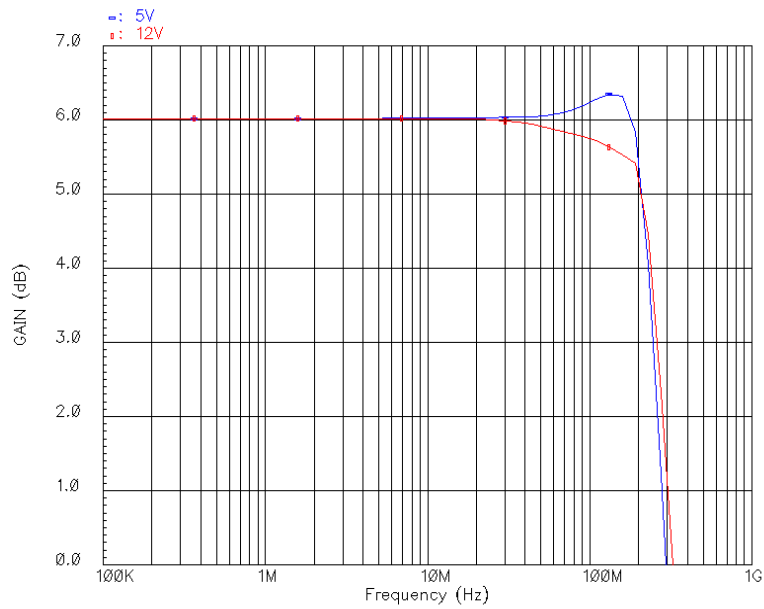

Typical Performance Characteristics At TA = 25°C, RF = RG = 510, gain = +2, RL = 100, Vs = 6V. Unless otherwise specified.

Pulse Response, Vs = ±2.5V

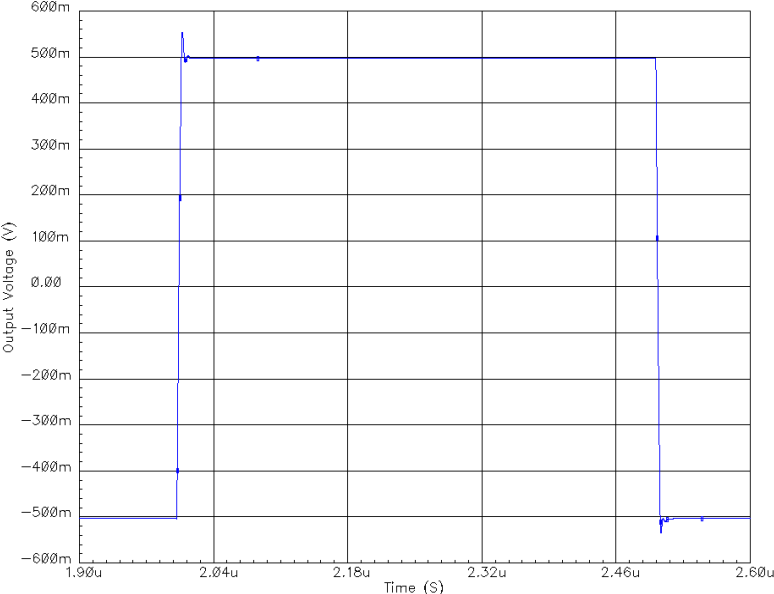

**Frequency Response
Gain = +5**

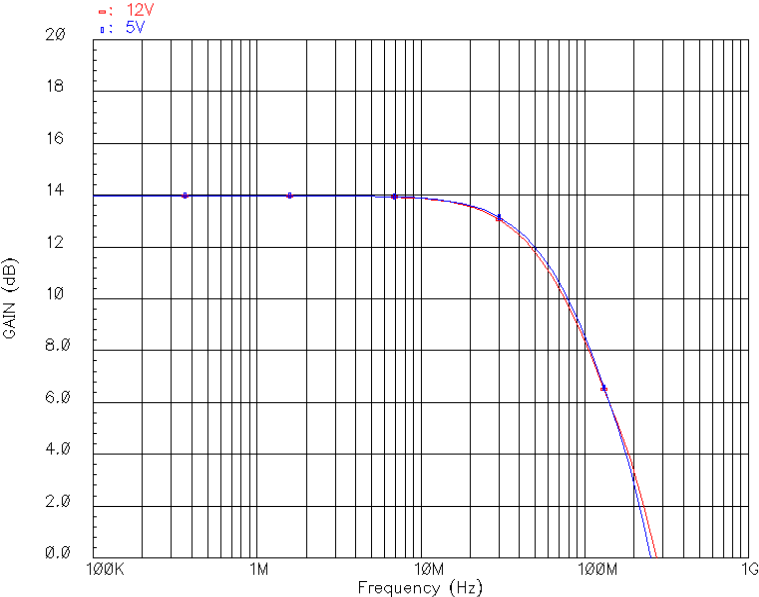

Typical Performance Characteristics At TA = 25°C, RF = RG = 510, gain = +2, RL = 100, Vs = 6V. Unless otherwise specified.

Frequency Response
Gain = +10

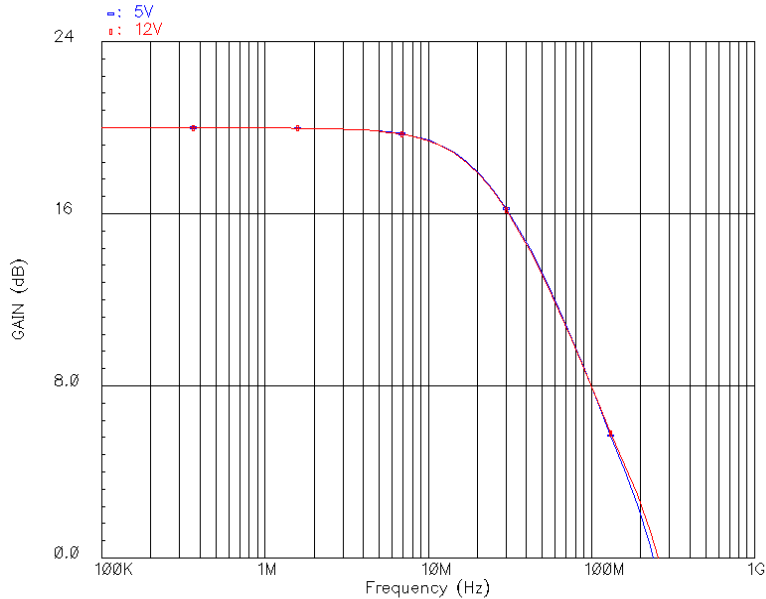

PSRR VS. Frequency

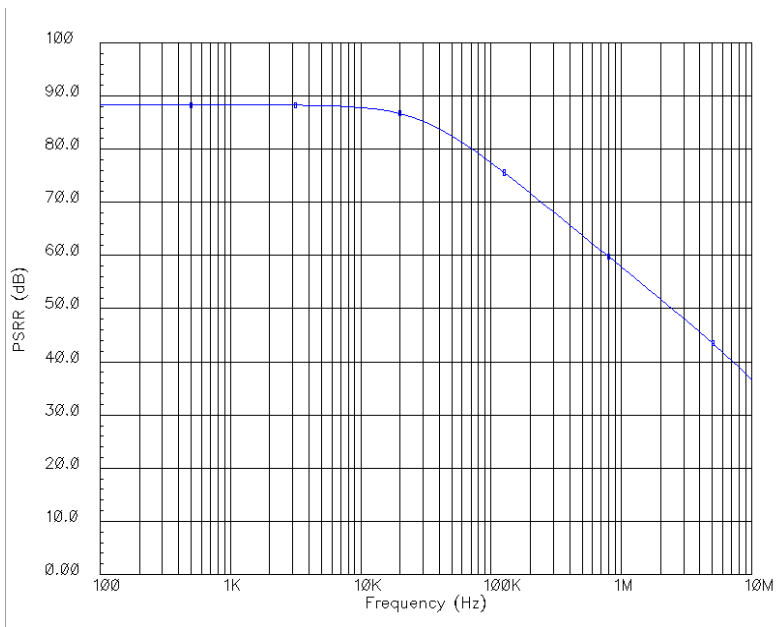

Typical Performance Characteristics At TA = 25°C, RF = RG = 510, gain = +2, RL = 100, Vs = 6V. Unless otherwise specified.

CMRR VS. Frequency

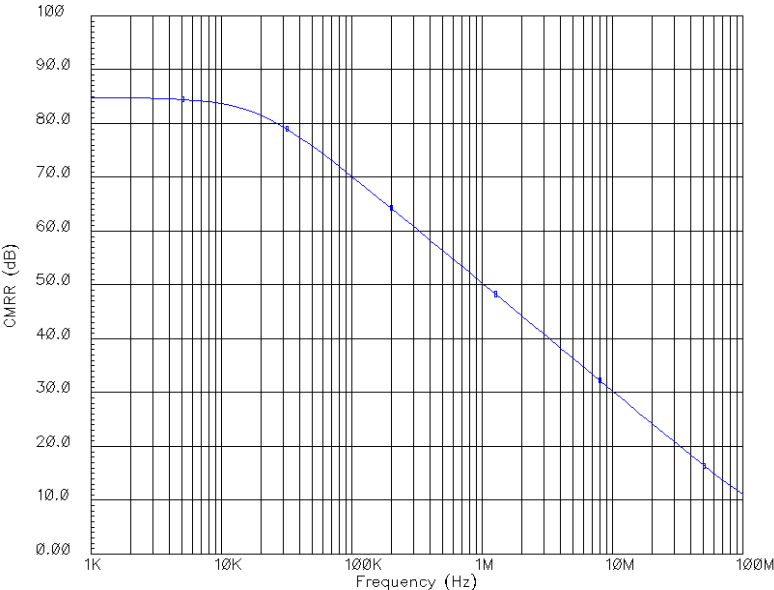

PSRR VS. Frequency
Vs = ±2.5V

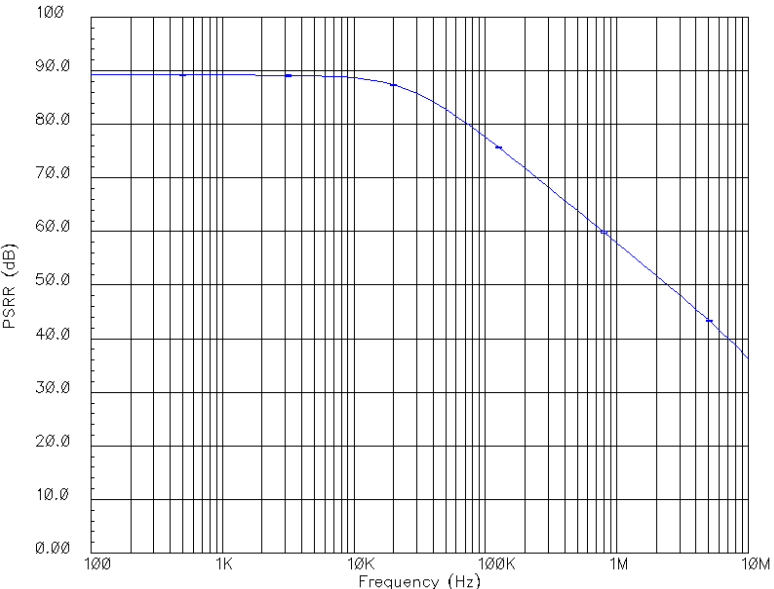

Typical Performance Characteristics At TA = 25°C, RF = RG = 510, gain = +2, RL = 100, Vs = 6V. Unless otherwise specified.

CMRR VS. Frequency
Vs = ±2.5V

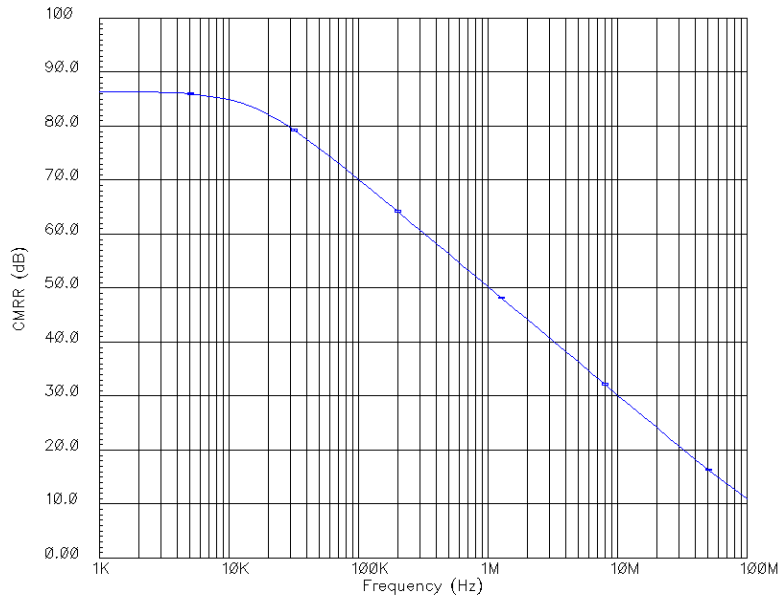

Noise Voltage VS. Frequency

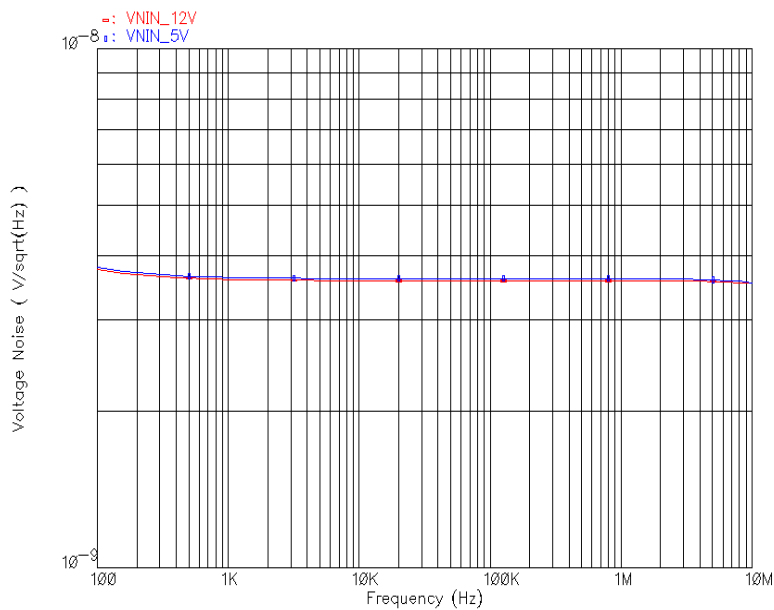

Typical Performance Characteristics At TA = 25°C, RF = RG = 510, gain = +2, RL = 100, Vs = 6V. Unless otherwise specified.

Current Noise VS. Frequency

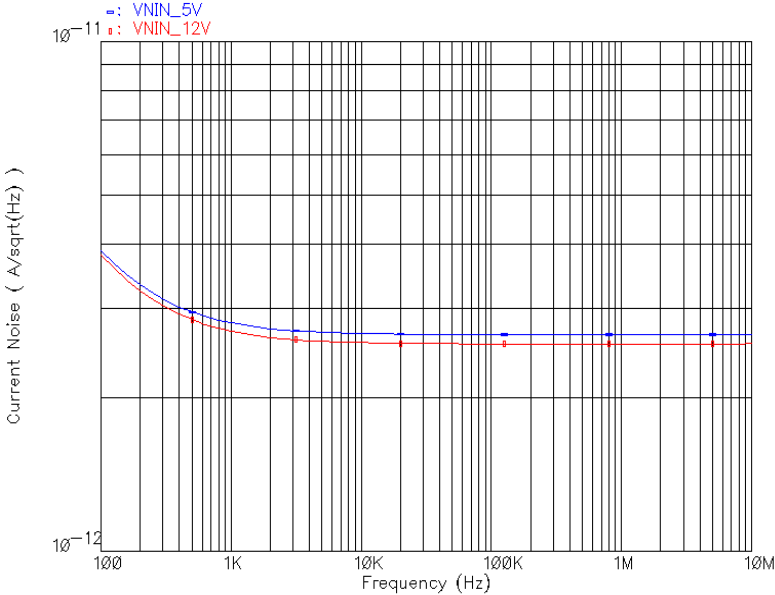

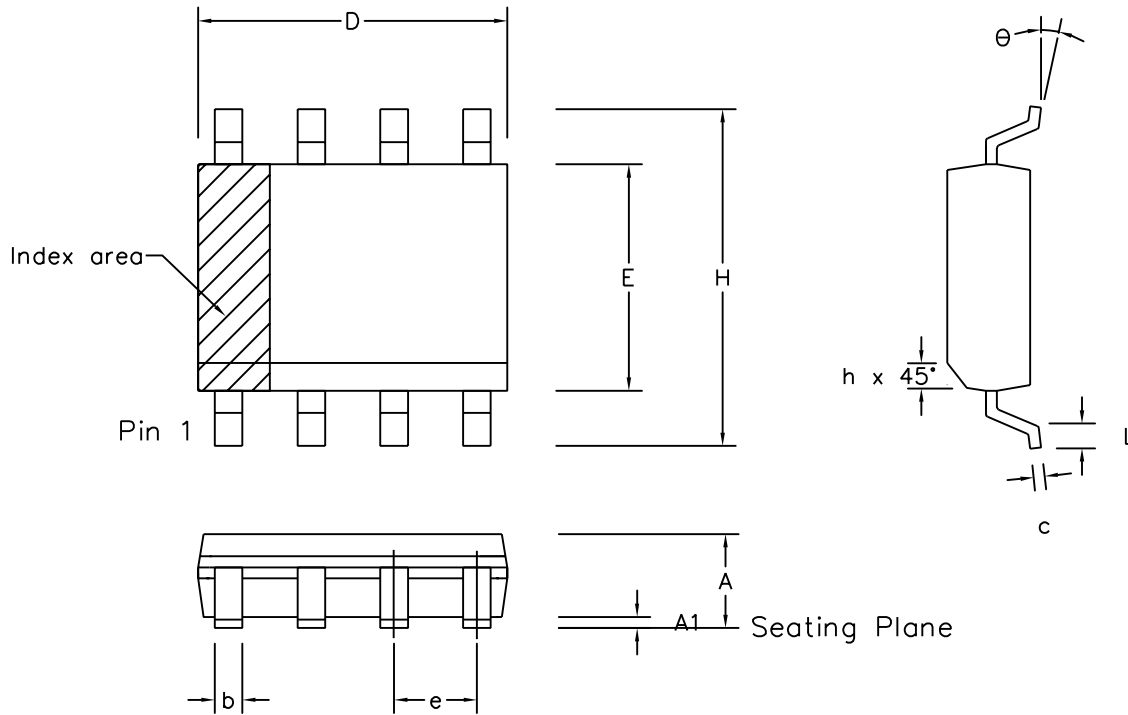

	Min mm	Max mm	Min inch	Max inch
A	1.35	1.75	0.053	0.069
A1	0.10	0.25	0.004	0.010
D	4.80	5.00	0.189	0.197
H	5.80	6.20	0.228	0.244
E	3.80	4.00	0.150	0.157
L	0.40	1.27	0.016	0.050
e	1.27 BSC		0.050 BSC	
b	0.33	0.51	0.013	0.020
c	0.19	0.25	0.008	0.010
O	0°	8°	0°	8°
h	0.25	0.50	0.010	0.020
Pin Features				
N	8		8	
Conforms to JEDEC MS-012AA Iss. C				

Notes:

1. The chamfer on the body is optional. If not present, a visual index feature, e.g. a dot, must be located within the cross-hatched area.
2. Controlling dimensions are in inches.
3. Dimension D do not include mould flash, protusion or gate burrs. These shall not exceed 0.006" per side.
4. Dimension $E1$ do not include inter-lead flash or protusion. These shall not exceed 0.010" per side.
5. Dimension b does not include dambar protusion / intrusion. Allowable dambar protusion shall be 0.004" total in excess of b dimension.

© Zarlink Semiconductor 2002 All rights reserved.							Package Code DC
ISSUE	1	2	3	4	5		Previous package codes
ACN	6745	201936	202595	203705	212424		MP / S
DATE	5Apr95	27Feb97	12Jun97	9Dec97	22Mar02		Package Outline for 8 lead SOIC (0.150" Body width)
APPRD.							GPD00010



**For more information about all Zarlink products
visit our Web Site at
www.zarlink.com**

Information relating to products and services furnished herein by Zarlink Semiconductor Inc. or its subsidiaries (collectively "Zarlink") is believed to be reliable. However, Zarlink assumes no liability for errors that may appear in this publication, or for liability otherwise arising from the application or use of any such information, product or service or for any infringement of patents or other intellectual property rights owned by third parties which may result from such application or use. Neither the supply of such information or purchase of product or service conveys any license, either express or implied, under patents or other intellectual property rights owned by Zarlink or licensed from third parties by Zarlink, whatsoever. Purchasers of products are also hereby notified that the use of product in certain ways or in combination with Zarlink, or non-Zarlink furnished goods or services may infringe patents or other intellectual property rights owned by Zarlink.

This publication is issued to provide information only and (unless agreed by Zarlink in writing) may not be used, applied or reproduced for any purpose nor form part of any order or contract nor to be regarded as a representation relating to the products or services concerned. The products, their specifications, services and other information appearing in this publication are subject to change by Zarlink without notice. No warranty or guarantee express or implied is made regarding the capability, performance or suitability of any product or service. Information concerning possible methods of use is provided as a guide only and does not constitute any guarantee that such methods of use will be satisfactory in a specific piece of equipment. It is the user's responsibility to fully determine the performance and suitability of any equipment using such information and to ensure that any publication or data used is up to date and has not been superseded. Manufacturing does not necessarily include testing of all functions or parameters. These products are not suitable for use in any medical products whose failure to perform may result in significant injury or death to the user. All products and materials are sold and services provided subject to Zarlink's conditions of sale which are available on request.

Purchase of Zarlink's I²C components conveys a licence under the Philips I²C Patent rights to use these components in and I²C System, provided that the system conforms to the I²C Standard Specification as defined by Philips.

Zarlink, ZL and the Zarlink Semiconductor logo are trademarks of Zarlink Semiconductor Inc.

Copyright Zarlink Semiconductor Inc. All Rights Reserved.

TECHNICAL DOCUMENTATION - NOT FOR RESALE
