

TOSHIBA Transistor Silicon NPN Epitaxial Planar Type

2SC5086

VHF~UHF Band Low Noise Amplifier Applications

Unit: mm

- Low noise figure, high gain.
- $NF = 1.1\text{dB}$, $|S_{21e}|^2 = 11\text{dB}$ ($f = 1\text{GHz}$)

Maximum Ratings ($T_a = 25^\circ\text{C}$)

Characteristics	Symbol	Rating	Unit
Collector-base voltage	V_{CBO}	20	V
Collector-emitter voltage	V_{CEO}	12	V
Emitter-base voltage	V_{EBO}	3	V
Base current	I_B	40	mA
Collector current	I_C	80	mA
Collector power dissipation	P_C	100	mW
Junction temperature	T_j	125	$^\circ\text{C}$
Storage temperature range	T_{stg}	-55~125	$^\circ\text{C}$

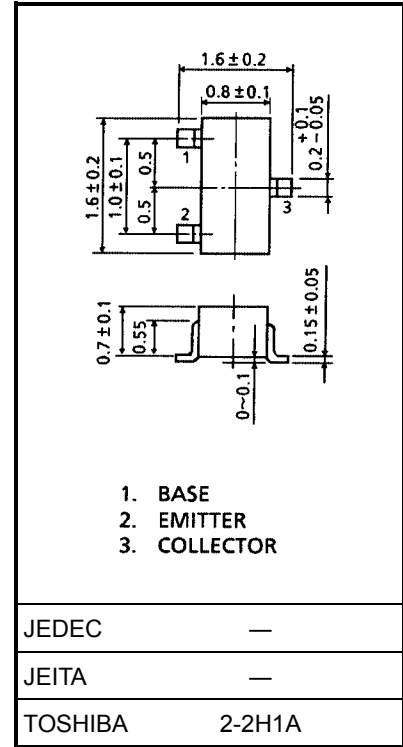

Microwave Characteristics ($T_a = 25^\circ\text{C}$)

Weight: 2.4 mg (typ.)

Characteristics	Symbol	Test Condition	Min	Typ.	Max	Unit
Transition frequency	f_T	$V_{CE} = 10\text{V}$, $I_C = 20\text{mA}$	5	7	—	GHz
Insertion gain	$ S_{21e} ^2 (1)$	$V_{CE} = 10\text{V}$, $I_C = 20\text{mA}$, $f = 500\text{MHz}$	—	16.5	—	dB
	$ S_{21e} ^2 (2)$	$V_{CE} = 10\text{V}$, $I_C = 20\text{mA}$, $f = 1\text{GHz}$	7.5	11	—	
Noise figure	NF (1)	$V_{CE} = 10\text{V}$, $I_C = 5\text{mA}$, $f = 500\text{MHz}$	—	1	—	dB
	NF (2)	$V_{CE} = 10\text{V}$, $I_C = 5\text{mA}$, $f = 1\text{GHz}$	—	1.1	2	

Electrical Characteristics ($T_a = 25^\circ\text{C}$)

Characteristics	Symbol	Test Condition	Min	Typ.	Max	Unit
Collector cut-off current	I_{CBO}	$V_{CB} = 10\text{V}$, $I_E = 0$	—	—	1	μA
Emitter cut-off current	I_{EBO}	$V_{EB} = 1\text{V}$, $I_C = 0$	—	—	1	μA
DC current gain	h_{FE} (Note 1)	$V_{CE} = 10\text{V}$, $I_C = 20\text{mA}$	80	—	240	
Output capacitance	C_{ob}	$V_{CB} = 10\text{V}$, $I_E = 0$, $f = 1\text{MHz}$ (Note 2)	—	1.0	—	pF
Reverse transfer capacitance	C_{re}		—	0.65	1.15	pF

Note 1: h_{FE} classification O: 80~160, Y: 120~240

Note 2: C_{re} is measured by 3 terminal method with capacitance bridge.

Marking

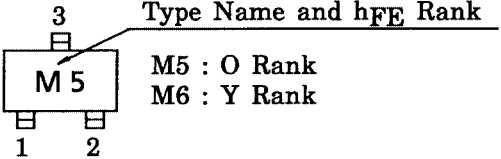

M5 : O Rank
M6 : Y Rank

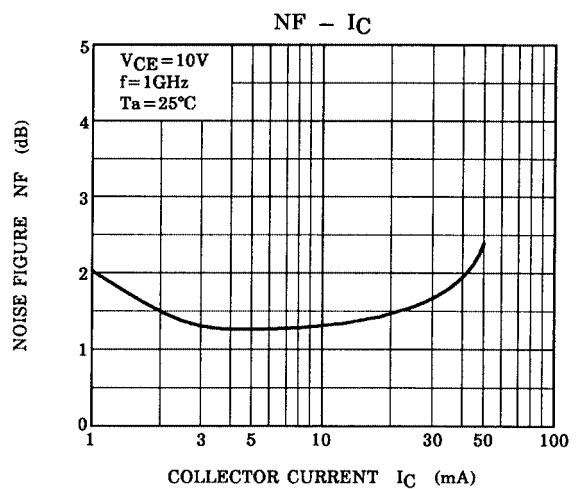
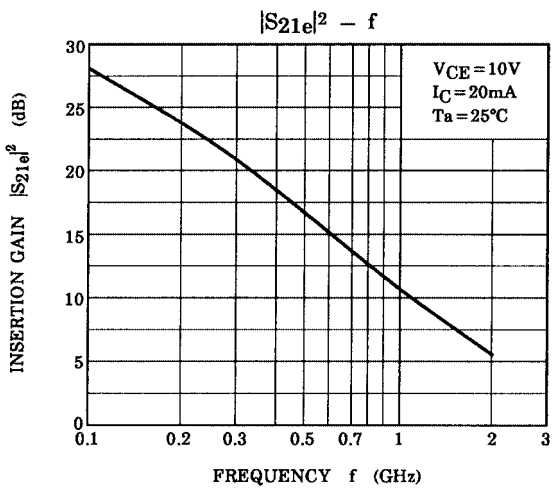
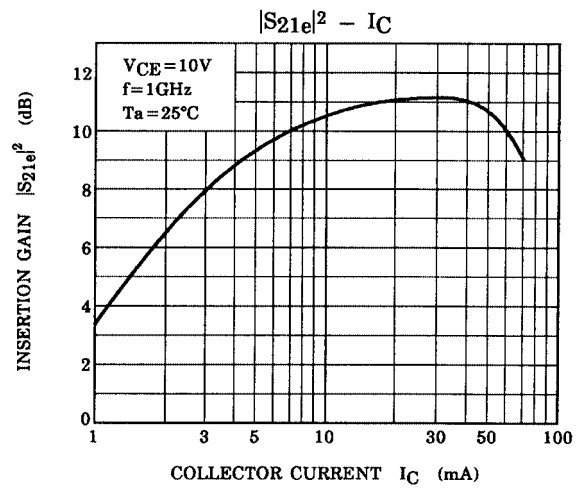
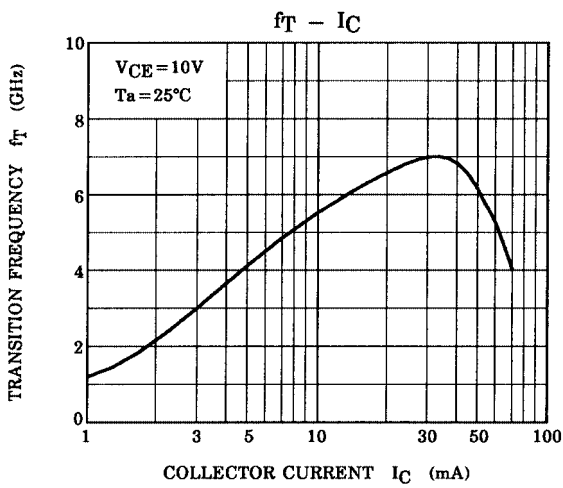
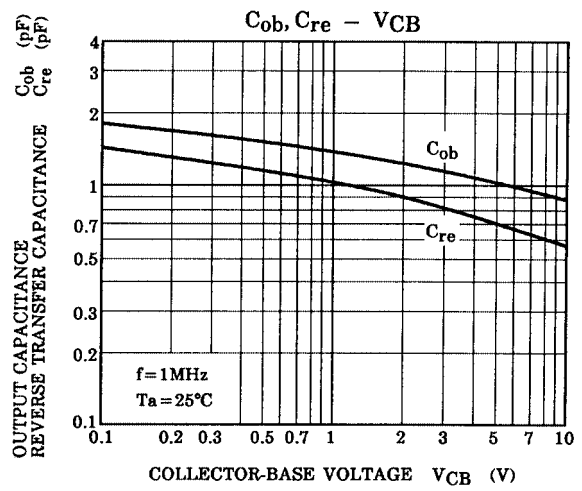
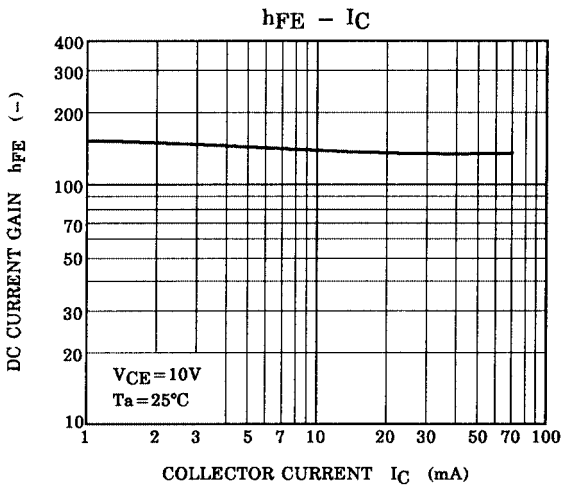

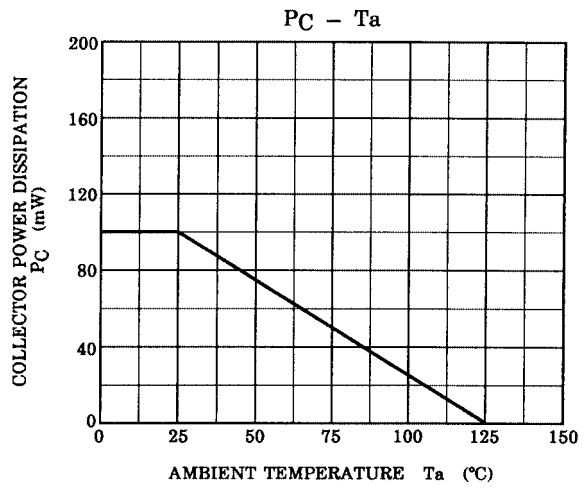
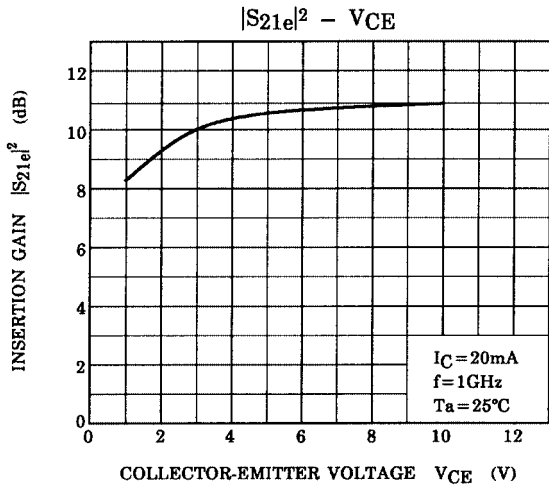

S-Parameter $Z_O = 50 \Omega, T_a = 25^\circ\text{C}$

$V_{CE} = 10 \text{ V}, I_C = 5 \text{ mA}$

Frequency (MHz)	S11		S21		S12		S22	
	Mag.	Ang.	Mag.	Ang.	Mag.	Ang.	Mag.	Ang.
200	0.715	-69.3	9.495	132.1	0.051	55.2	0.747	-29.0
400	0.542	-112.4	6.482	108.5	0.068	46.8	0.555	-35.1
600	0.476	-137.7	4.717	95.8	0.077	47.9	0.478	-36.2
800	0.447	-154.4	3.691	87.1	0.086	51.6	0.442	-37.1
1000	0.435	-166.8	3.049	79.9	0.096	55.9	0.424	-38.9
1200	0.433	-176.6	2.611	73.9	0.108	60.4	0.418	-41.8
1400	0.435	174.8	2.294	68.3	0.123	64.2	0.411	-45.0
1600	0.439	167.3	2.050	63.2	0.140	66.9	0.407	-49.0
1800	0.444	160.6	1.860	58.7	0.159	68.7	0.406	-53.6
2000	0.454	154.2	1.713	53.9	0.180	70.5	0.404	-57.8

$V_{CE} = 10 \text{ V}, I_C = 20 \text{ mA}$

Frequency (MHz)	S11		S21		S12		S22	
	Mag.	Ang.	Mag.	Ang.	Mag.	Ang.	Mag.	Ang.
200	0.465	-107.8	16.512	113.2	0.035	56.7	0.484	-40.9
400	0.375	-145.6	9.090	96.5	0.052	62.2	0.331	-37.8
600	0.351	-164.4	6.252	88.1	0.070	66.5	0.291	-34.1
800	0.343	-176.7	4.762	81.9	0.089	68.9	0.277	-33.3
1000	0.338	174.8	3.875	76.6	0.109	70.2	0.273	-34.0
1200	0.337	167.9	3.285	71.8	0.130	70.8	0.274	-36.2
1400	0.343	161.6	2.874	67.2	0.152	70.6	0.274	-39.3
1600	0.343	156.2	2.553	62.9	0.173	69.8	0.274	-43.4
1800	0.348	151.2	2.317	58.8	0.195	68.9	0.273	-47.8
2000	0.354	146.2	2.113	55.0	0.218	68.2	0.272	-52.1

S11e
 VCE=10V
 IC=5mA
 Ta=25°C
 (UNIT : Ω)

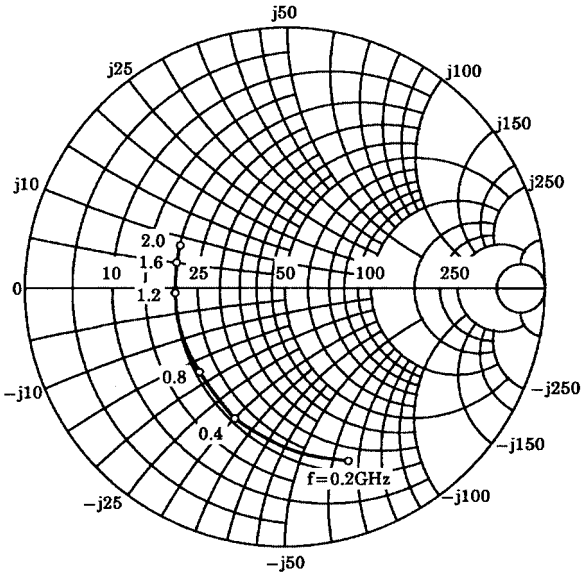

S21e
 VCE=10V
 IC=5mA
 Ta=25°C

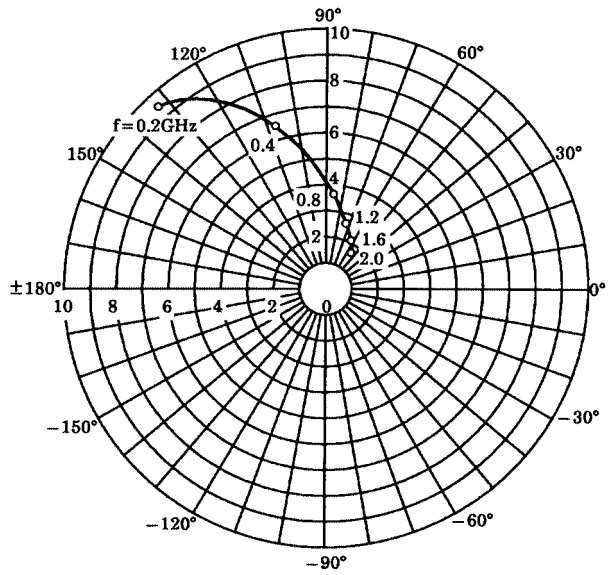

S12e
 VCE=10V
 IC=5mA
 Ta=25°C

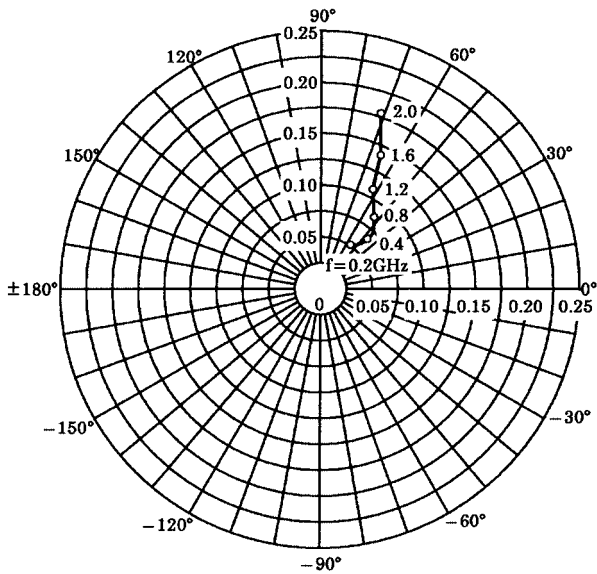

S22e
 VCE=10V
 IC=5mA
 Ta=25°C
 (UNIT : Ω)

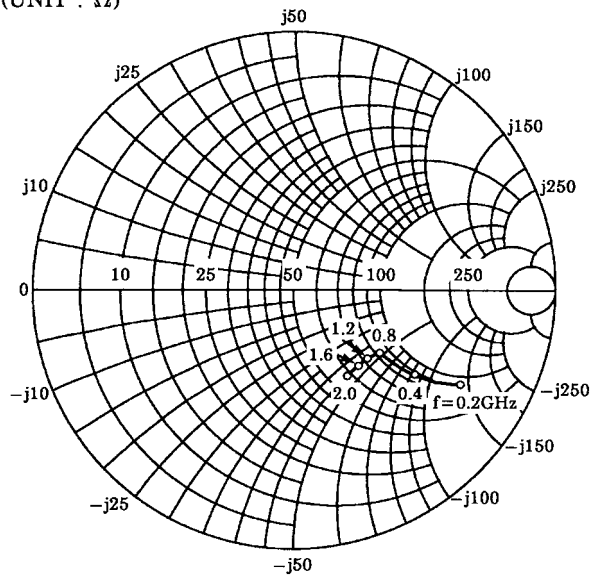

S_{11e}
 V_{CE} = 10V
 I_C = 20mA
 T_a = 25°C
 (UNIT : Ω)

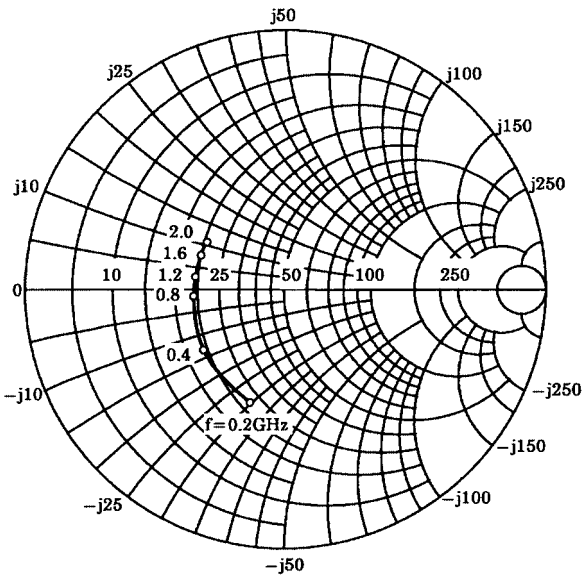

S_{21e}
 V_{CE} = 10V
 I_C = 20mA
 T_a = 25°C

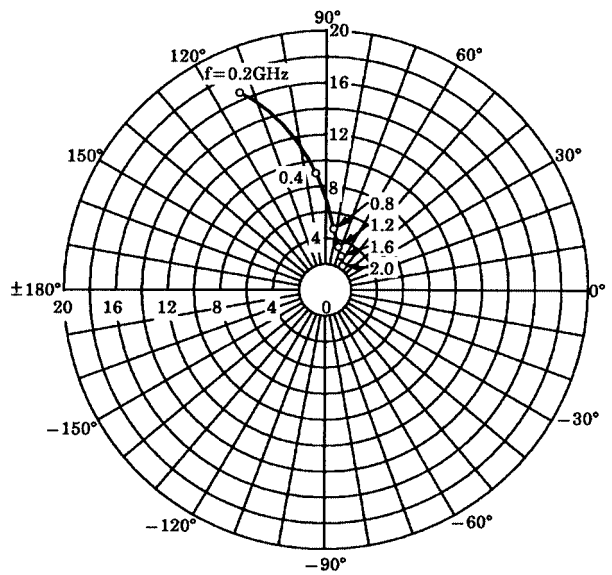

S_{12e}
 V_{CE} = 10V
 I_C = 20mA
 T_a = 25°C

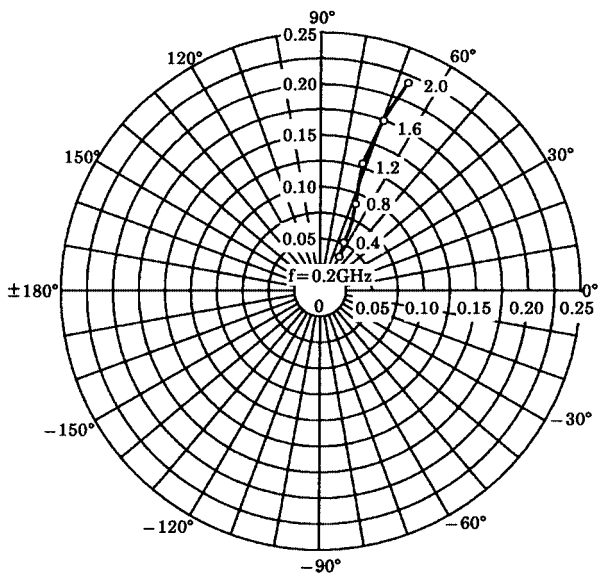

S_{22e}
 V_{CE} = 10V
 I_C = 20mA
 T_a = 25°C
 (UNIT : Ω)

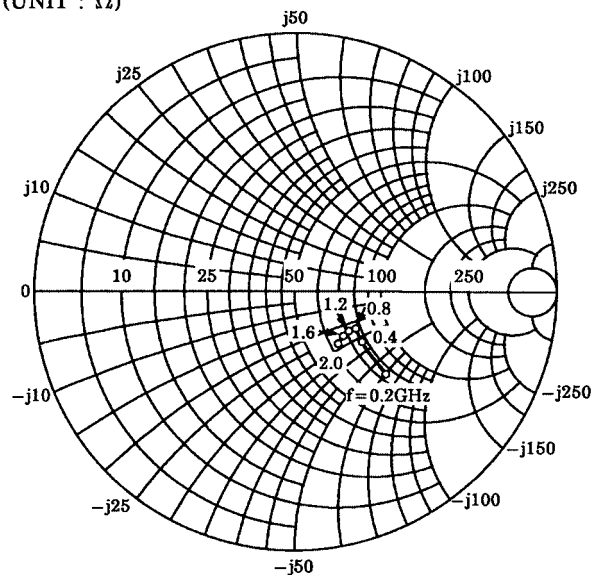

RESTRICTIONS ON PRODUCT USE

000707EAA

- TOSHIBA is continually working to improve the quality and reliability of its products. Nevertheless, semiconductor devices in general can malfunction or fail due to their inherent electrical sensitivity and vulnerability to physical stress. It is the responsibility of the buyer, when utilizing TOSHIBA products, to comply with the standards of safety in making a safe design for the entire system, and to avoid situations in which a malfunction or failure of such TOSHIBA products could cause loss of human life, bodily injury or damage to property.
In developing your designs, please ensure that TOSHIBA products are used within specified operating ranges as set forth in the most recent TOSHIBA products specifications. Also, please keep in mind the precautions and conditions set forth in the "Handling Guide for Semiconductor Devices," or "TOSHIBA Semiconductor Reliability Handbook" etc..
- The TOSHIBA products listed in this document are intended for usage in general electronics applications (computer, personal equipment, office equipment, measuring equipment, industrial robotics, domestic appliances, etc.). These TOSHIBA products are neither intended nor warranted for usage in equipment that requires extraordinarily high quality and/or reliability or a malfunction or failure of which may cause loss of human life or bodily injury ("Unintended Usage"). Unintended Usage include atomic energy control instruments, airplane or spaceship instruments, transportation instruments, traffic signal instruments, combustion control instruments, medical instruments, all types of safety devices, etc.. Unintended Usage of TOSHIBA products listed in this document shall be made at the customer's own risk.
- The information contained herein is presented only as a guide for the applications of our products. No responsibility is assumed by TOSHIBA CORPORATION for any infringements of intellectual property or other rights of the third parties which may result from its use. No license is granted by implication or otherwise under any intellectual property or other rights of TOSHIBA CORPORATION or others.
- The information contained herein is subject to change without notice.