

**Dual common source
NPT IGBT Power Module**

**$V_{CES} = 1200V$
 $I_C = 300A @ T_c = 80^\circ C$**

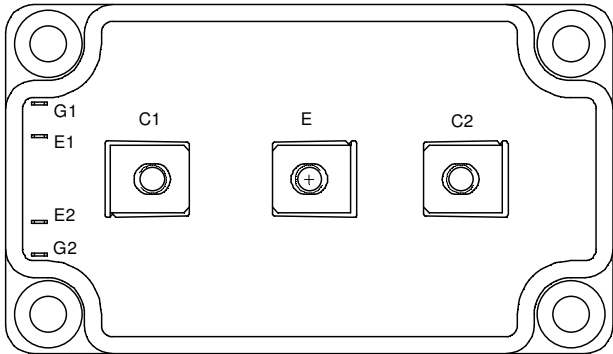
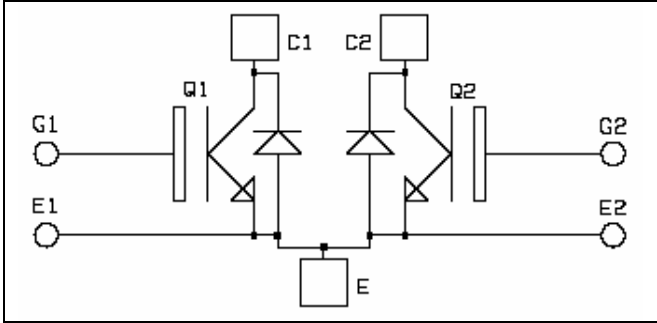

Application

- AC Switches
- Switched Mode Power Supplies
- Uninterruptible Power Supplies

Features

- Non Punch Through (NPT) FAST IGBT
 - Low voltage drop
 - Low tail current
 - Switching frequency up to 50 kHz
 - Soft recovery parallel diodes
 - Low diode VF
 - Low leakage current
 - Avalanche energy rated
 - RBSOA and SCSOA rated
- Kelvin emitter for easy drive
- Very low stray inductance
 - Symmetrical design
 - M5 power connectors
- High level of integration

Benefits

- Outstanding performance at high frequency operation
- Stable temperature behavior
- Very rugged
- Direct mounting to heatsink (isolated package)
- Low junction to case thermal resistance
- Easy paralleling due to positive TC of VCEsat
- Low profile

Absolute maximum ratings

Symbol	Parameter	Max ratings	Unit
V_{CES}	Collector - Emitter Breakdown Voltage	1200	V
I_C	Continuous Collector Current	$T_c = 25^\circ C$	400
		$T_c = 80^\circ C$	300
I_{CM}	Pulsed Collector Current	$T_c = 25^\circ C$	800
V_{GE}	Gate - Emitter Voltage	± 20	V
P_D	Maximum Power Dissipation	$T_c = 25^\circ C$	2080
RBSOA	Reverse Bias Safe Operating Area	$T_j = 150^\circ C$	600A @ 1200V

CAUTION: These Devices are sensitive to Electrostatic Discharge. Proper Handling Procedures Should Be Followed.

All ratings @ $T_j = 25^\circ\text{C}$ unless otherwise specified

Electrical Characteristics

Symbol	Characteristic	Test Conditions	Min	Typ	Max	Unit
BV_{CES}	Collector - Emitter Breakdown Voltage	$V_{GE} = 0V, I_C = 4mA$	1200			V
I_{CES}	Zero Gate Voltage Collector Current	$V_{GE} = 0V$ $V_{CE} = 1200V$	$T_j = 25^\circ\text{C}$	0.4	6	mA
			$T_j = 125^\circ\text{C}$	25		
$V_{CE(on)}$	Collector Emitter on Voltage	$V_{GE} = 15V$ $I_C = 300A$	$T_j = 25^\circ\text{C}$	3.3	3.9	V
			$T_j = 125^\circ\text{C}$	4		
$V_{GE(th)}$	Gate Threshold Voltage	$V_{GE} = V_{CE}, I_C = 12mA$	4.5		6.5	V
I_{GES}	Gate - Emitter Leakage Current	$V_{GE} = \pm 20V, V_{CE} = 0V$			± 1	μA

Dynamic Characteristics

Symbol	Characteristic	Test Conditions	Min	Typ	Max	Unit
C_{ies}	Input Capacitance	$V_{GE} = 0V$ $V_{CE} = 25V$ $f = 1MHz$		21		nF
C_{oes}	Output Capacitance			2.9		
C_{res}	Reverse Transfer Capacitance			1.52		
$T_{d(on)}$	Turn-on Delay Time	Inductive Switching (125°C) $V_{GE} = 15V$ $V_{Bus} = 600V$ $I_C = 300A$ $R_G = 2\Omega$		70		ns
T_r	Rise Time			50		
$T_{d(off)}$	Turn-off Delay Time			500		
T_f	Fall Time			30		
E_{on}	Turn-on Switching Energy				17	mJ
E_{off}	Turn-off Switching Energy				18	

Reverse diode ratings and characteristics

Symbol	Characteristic	Test Conditions	Min	Typ	Max	Unit
$I_{F(AV)}$	Maximum Average Forward Current	50% duty cycle $T_c = 85^\circ\text{C}$		250		A
V_F	Diode Forward Voltage	$I_F = 300A$		2.2	2.5	V
		$I_F = 400A$		2.4		
		$I_F = 400A$ $T_j = 150^\circ\text{C}$		2.2		
Q_{rr}	Reverse Recovery Charge	$I_F = 300A$	$T_j = 25^\circ\text{C}$	13		μC
			$T_j = 125^\circ\text{C}$	40		

Typical Performance Curve

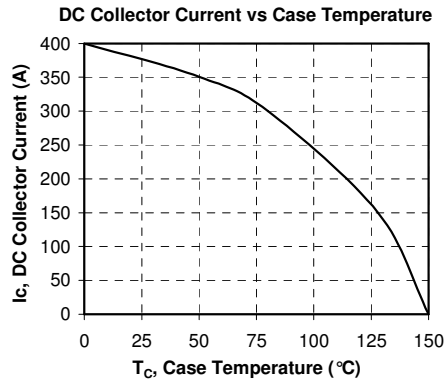
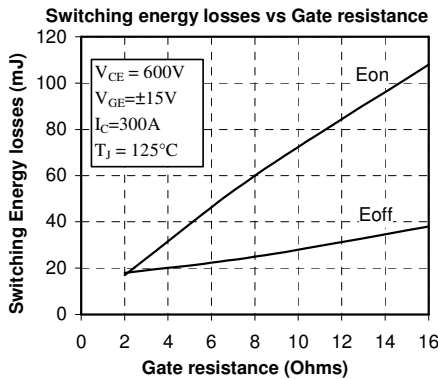
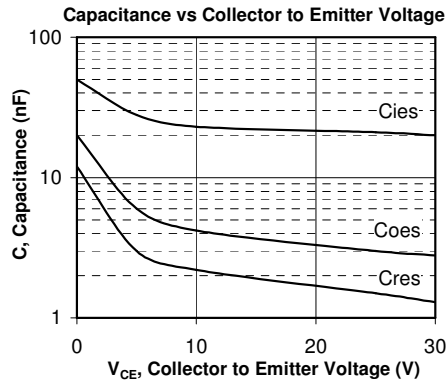
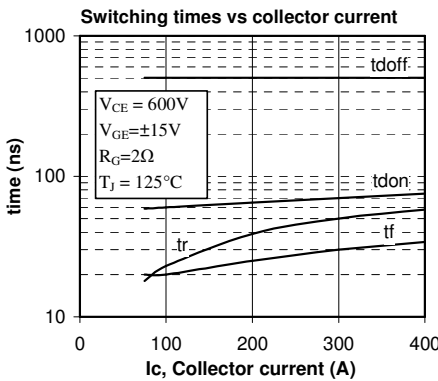
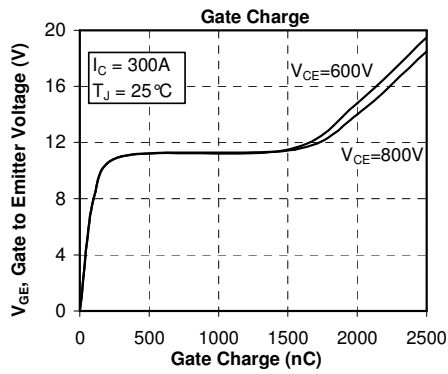
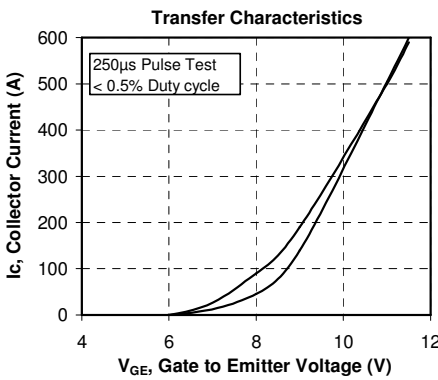
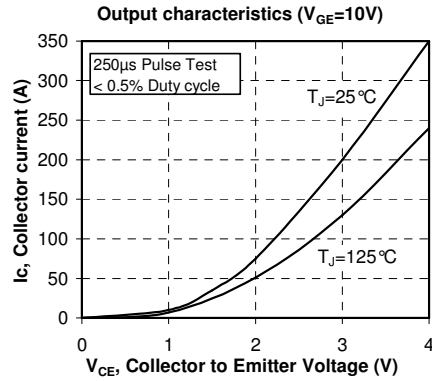
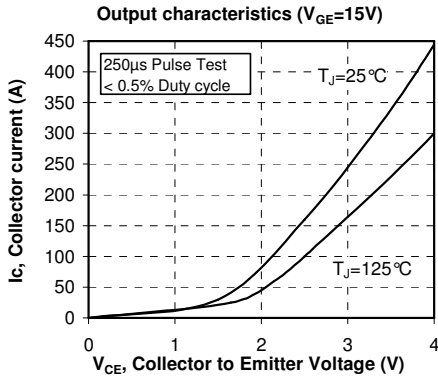

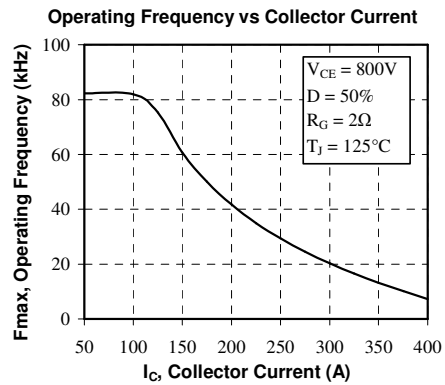
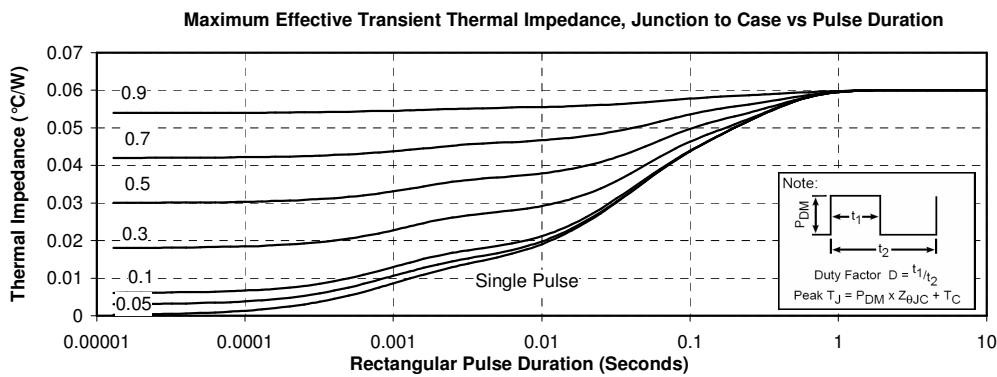
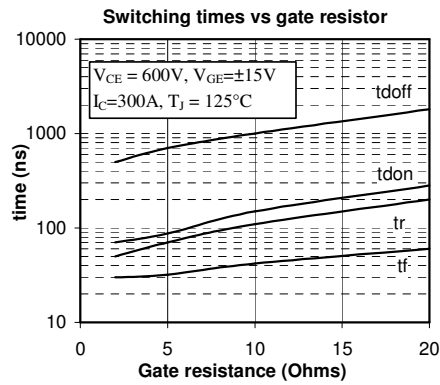
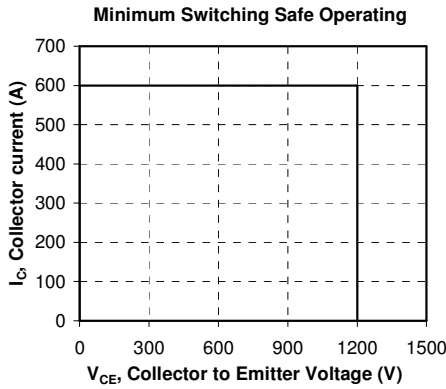

APT reserves the right to change, without notice, the specifications and information contained herein

APT's products are covered by one or more of U.S patents 4,895,810 5,045,903 5,089,434 5,182,234 5,019,522 5,262,336 6,503,786 5,256,583 4,748,103 5,283,202 5,231,474 5,434,095 5,528,058 and foreign patents. U.S and Foreign patents pending. All Rights Reserved.