



# 1 of 2:8 Differential Clock/Data Fanout Buffer

## Features

- Eight ECL/PECL differential outputs
- Two ECL/PECL differential inputs
- Hot-swappable/-insertable
- 50 ps output-to-output skew
- 150 ps device-to-device skew
- 500 ps propagation delay (typical)
- 1.5 GHz Operation (2.2 GHz max. toggle frequency)
- 1.2 ps RMS period jitter (typ.)
- PECL mode supply range:  $V_{CC} = 2.5V \pm 5\%$  to  $3.3V \pm 5\%$  with  $V_{EE} = 0V$
- ECL mode supply range:  $V_{EE} = -2.5V \pm 5\%$  to  $-3.3V \pm 5\%$  with  $V_{CC} = 0V$
- Industrial temperature range:  $-40^{\circ}C$  to  $85^{\circ}C$
- 28-pin PLCC package
- Temperature compensation like 100K ECL

## Functional Description

The CY2PP318 is a low-skew, low propagation delay 1-to-8 differential fanout buffer targeted to meet the requirements of high-performance clock and data distribution applications. The device is implemented on SiGe technology and has a fully differential internal architecture that is optimized to achieve low signal skews at operating frequencies of up to 1.5 GHz.

The device features two differential input paths that are multiplexed internally. This mux is controlled by the CLK\_SEL pin. The CY2PP318 may function not only as a differential clock buffer but also as a signal-level translator and fanout on ECL/PECL signal to eight ECL/PECL differential loads. An external bias pin, VBB, is provided for this purpose. In such an application, the VBB pin should be connected to either one of the CLKA# or CLKB# inputs and bypassed to ground via a 0.01- $\mu F$  capacitor.

Since the CY2PP318 introduces negligible jitter to the timing budget, it is the ideal choice for distributing high frequency, high precision clocks across back-planes and boards in communication systems. Furthermore, advanced circuit design schemes, such as internal temperature compensation, ensure that the CY2PP318 delivers consistent performance over various platforms.

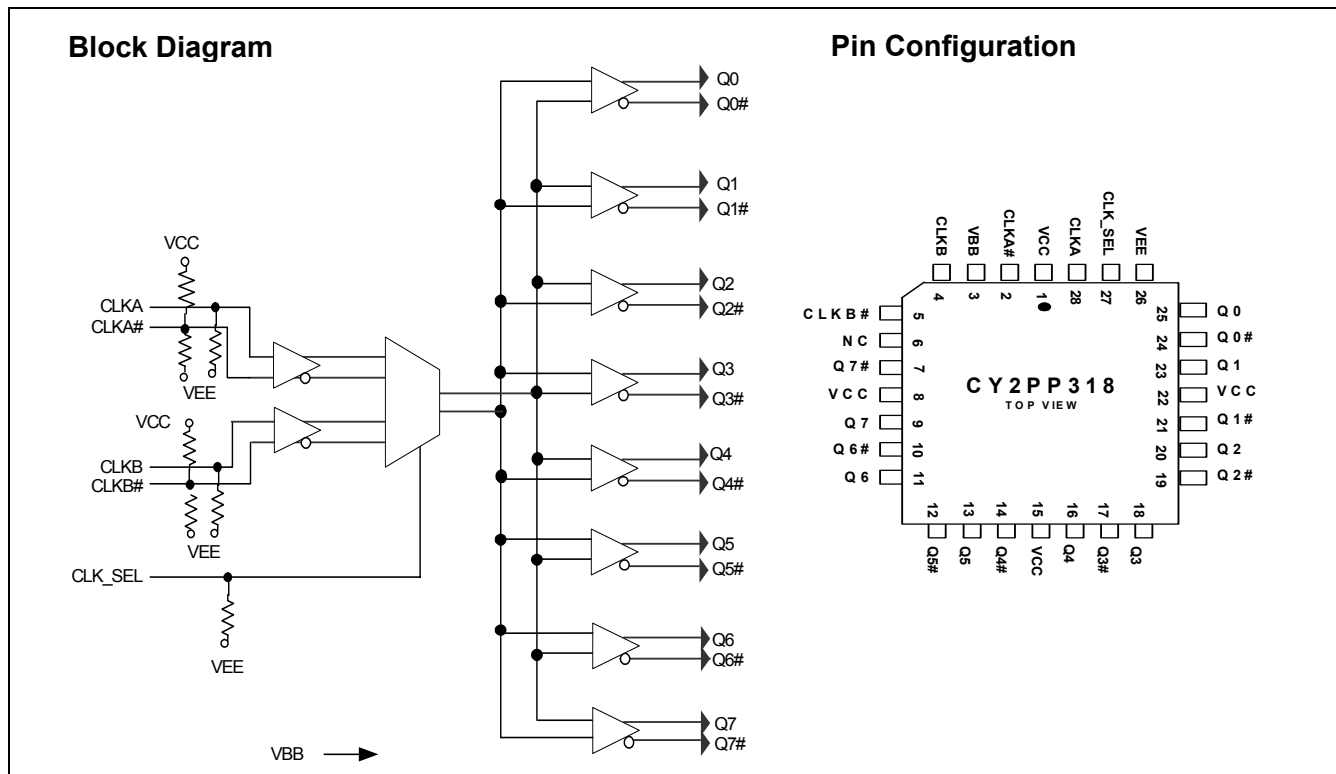

**Pin Definitions**<sup>[1, 2, 3]</sup>

Pin	Name	I/O	Type	Description
3	VBB	O	Bias	Reference Voltage Output
26	VEE	-PWR	Power	Negative Supply
1, 8, 15, 22	VCC	+PWR	Power	Positive Supply
28	CLKA	I, PD	ECL/PECL	ECL/PECL Differential Input Clocks
2	CLKA#	I, PD/PU	ECL/PECL	ECL/PECL Differential Input Clocks
4	CLKB	I, PD	ECL/PECL	ECL/PECL Differential Input Clocks
5	CLKB#	I, PD/PU	ECL/PECL	ECL/PECL Differential Input Clocks
27	CLK_SEL	I, PD	ECL/PECL	ECL/PECL Input Clock Select
6	NC			No Connect
25,23,20,18,16,13,11,9	Q(0:7)	O	ECL/PECL	ECL/PECL Differential Output Clocks
24,21,19,17,14,12,10,7	Q(0:7)#	O	ECL/PECL	ECL/PECL Differential Output Clocks

**Table 1.**

Control	Operation
CLK_SEL	
0	CLKA, CLKA# input pair is active (Default condition with no connection to pin) CLKA can be driven with ECL- or PECL-compatible signals with respective power configurations
1	CLKB, CLKB# input pair is active. CLKB can be driven with ECL- or PECL-compatible signals with respective power configurations

**Governing Agencies**

The following agencies provide specifications that apply to the CY2PP318. The agency name and relevant specification is listed below in *Table 2*.

**Table 2.**

Agency Name	Specification
JEDEC	JESD 020B (MSL) JESD 51 (Theta JA) JESD 8-2 (ECL) JESD 65-B (skew,jitter)
Mil-Spec	883E Method 1012.1 (Thermal Theta JC)

**Notes:**

- In the I/O column, the following notation is used: I for Input, O for Output, PD for Pull-Down, PU for Pull-Up, and PWR for Power
- In ECL mode (negative power supply mode),  $V_{EE}$  is either  $-3.3V$  or  $-2.5V$  and  $V_{CC}$  is connected to GND (0V). In PECL mode (positive power supply mode),  $V_{EE}$  is connected to GND (0V) and  $V_{CC}$  is either  $+3.3V$  or  $+2.5V$ . In both modes, the input and output levels are referenced to the most positive supply ( $V_{CC}$ ) and are between  $V_{CC}$  and  $V_{EE}$ .
- $V_{BB}$  is available for use for single-ended bias mode for  $|3.3V|$  supplies (not  $|2.5V|$ ).

**Absolute Maximum Ratings**

Parameter	Description	Condition	Min.	Max.	Unit
V <sub>CC</sub>	Positive Supply Voltage	Non-Functional	-0.3	4.6	V
V <sub>EE</sub>	Negative Supply Voltage	Non-Functional	-4.6	0.3	V
T <sub>S</sub>	Temperature, Storage	Non-Functional	-65	+150	°C
T <sub>J</sub>	Temperature, Junction	Non-Functional		150	°C
ESD <sub>h</sub>	ESD Protection	Human Body Model		2000	V
M <sub>SL</sub>	Moisture Sensitivity Level			3	N.A.
Gate Count	Total Number of Used Gates	Assembled Die		28	gates

**Multiple Supplies:** The Voltage on any input or I/O pin cannot exceed the power pin during power-up. Power supply sequencing is NOT required.

**Operating Conditions**

Parameter	Description	Condition	Min.	Max.	Unit
I <sub>BB</sub>	Output Reference Current	Relative to V <sub>BB</sub>		200	uA
LU <sub>I</sub>	Latch Up Immunity	Functional, typical		100	mA
T <sub>A</sub>	Temperature, Operating Ambient	Functional	-40	+85	°C
∅ <sub>Jc</sub>	Dissipation, Junction to Case	Functional		39 <sup>[4]</sup>	°C/W
∅ <sub>Ja</sub>	Dissipation, Junction to Ambient	Functional		60 <sup>[4]</sup>	°C/W
I <sub>EE</sub>	Maximum Quiescent Supply Current	V <sub>EE</sub> pin		100 <sup>[5]</sup>	mA
C <sub>IN</sub>	Input pin capacitance			3	pF
L <sub>IN</sub>	Pin Inductance			1	nH
V <sub>IN</sub>	Input Voltage	Relative to V <sub>CC</sub> <sup>[6]</sup>	-0.3	V <sub>CC</sub> + 0.3	V
V <sub>TT</sub>	Output Termination Voltage	Relative to V <sub>CC</sub> <sup>[6]</sup>		V <sub>CC</sub> - 2	V
V <sub>OUT</sub>	Output Voltage	Relative to V <sub>CC</sub> <sup>[6]</sup>	-0.3	V <sub>CC</sub> + 0.3	V
I <sub>IN</sub>	Input Current <sup>[7]</sup>	V <sub>IN</sub> = V <sub>IL</sub> or V <sub>IN</sub> = V <sub>IH</sub>		150	uA

**PECL DC Electrical Specifications**

Parameter	Description	Condition	Min.	Max.	Unit
V <sub>CC</sub>	Operating Voltage	2.5V ± 5%, V <sub>EE</sub> = 0.0V 3.3V ± 5%, V <sub>EE</sub> = 0.0V	2.375 3.135	2.625 3.465	V V
V <sub>CMR</sub>	Differential Cross Point Voltage <sup>[8]</sup>	Differential operation	1.2	V <sub>CC</sub>	V
V <sub>OH</sub>	Output High Voltage	I <sub>OH</sub> = -30 mA <sup>[9]</sup>	V <sub>CC</sub> - 1.25	V <sub>CC</sub> - 0.7	V
V <sub>OL</sub>	Output Low Voltage V <sub>CC</sub> = 3.3V ± 5% V <sub>CC</sub> = 2.5V ± 5%	I <sub>OL</sub> = -5 mA <sup>[9]</sup>	V <sub>CC</sub> - 1.995 V <sub>CC</sub> - 1.995	V <sub>CC</sub> - 1.5 V <sub>CC</sub> - 1.3	V V
V <sub>IH</sub>	Input Voltage, High	Single-ended operation	V <sub>CC</sub> - 1.165	V <sub>CC</sub> - 0.880 <sup>[10]</sup>	V
V <sub>IL</sub>	Input Voltage, Low	Single-ended operation	V <sub>CC</sub> - 1.945 <sup>[10]</sup>	V <sub>CC</sub> - 1.625	V
V <sub>BB</sub> <sup>[3]</sup>	Output Reference Voltage	Relative to V <sub>CC</sub> <sup>[6]</sup>	V <sub>CC</sub> - 1.620	V <sub>CC</sub> - 1.220	V

**Notes:**

- Theta JA EIA JEDEC 51 test board conditions (typical value); Theta JC 883E Method 1012.1
- Power Calculation: V<sub>CC</sub> \* I<sub>EE</sub> + 0.5 (I<sub>OH</sub> + I<sub>OL</sub>) (V<sub>OH</sub> - V<sub>OL</sub>) (number of differential outputs used); I<sub>EE</sub> does not include current going off chip.
- where V<sub>CC</sub> is 3.3V±5% or 2.5V±5%
- Inputs have internal pull-up/pull-down or biasing resistors which affect the input current.
- Refer to Figure 1
- Equivalent to a termination of 50Ω to V<sub>TT</sub>. I<sub>OHMIN</sub>=(V<sub>OHMIN</sub>-V<sub>TT</sub>)/50; I<sub>OHMAX</sub>=(V<sub>OHMAX</sub>-V<sub>TT</sub>)/50; I<sub>OLMIN</sub>=(V<sub>OLMIN</sub>-V<sub>TT</sub>)/50; I<sub>OLMAX</sub>=(V<sub>OLMAX</sub>-V<sub>TT</sub>)/50;
- V<sub>IL</sub> will operate down to V<sub>EE</sub>; V<sub>IH</sub> will operate up to V<sub>CC</sub>

**ECL DC Electrical Specifications**

Parameter	Description	Condition	Min.	Max.	Unit
V <sub>EE</sub>	Negative Power Supply	-2.5V ± 5%, V <sub>CC</sub> = 0.0V -3.3V ± 5%, V <sub>CC</sub> = 0.0V	-2.625 -3.465	-2.375 -3.135	V
V <sub>CMR</sub>	Differential cross point voltage <sup>[8]</sup>	Differential operation	V <sub>EE</sub> + 1.2	0V	V
V <sub>OH</sub>	Output High Voltage	I <sub>OH</sub> = -30 mA <sup>[9]</sup>	-1.25	-0.7	V
V <sub>OL</sub>	Output Low Voltage V <sub>EE</sub> = -3.3V ± 5% V <sub>EE</sub> = -2.5V ± 5%	I <sub>OL</sub> = -5 mA <sup>[9]</sup>	-1.995 -1.995	-1.5 -1.3	V
V <sub>IH</sub>	Input Voltage, High	Single-ended operation	-1.165	-0.880 <sup>[10]</sup>	V
V <sub>IL</sub>	Input Voltage, Low	Single-ended operation	-1.945 <sup>[10]</sup>	-1.625	V
V <sub>BB</sub> <sup>[3]</sup>	Output Reference Voltage		-1.620	-1.220	V

**AC Electrical Specifications**

Parameter	Description	Condition	Min.	Max.	Unit
V <sub>PP</sub>	Differential Input Voltage <sup>[8]</sup>	Differential operation	0.1	1.3	V
F <sub>CLK</sub>	Input Frequency	50% duty cycle Standard load		1.5	GHz
T <sub>PD</sub>	Propagation Delay CLKA or CLKB to Output pair	660 MHz <sup>[11]</sup>	400	680	ps
V <sub>o</sub>	Output Voltage (peak-to-peak; see Figure 2)	< 1 GHz	0.375	-	V
V <sub>CMRO</sub>	Output Common Voltage Range (typ.)		V <sub>CC</sub> - 1.425		V
tsk <sub>(0)</sub>	Output-to-output Skew	660 MHz <sup>[11]</sup> , See Figure 3	-	50	ps
tsk <sub>(PP)</sub>	Part-to-Part Output Skew	660 MHz <sup>[11]</sup>	-	150	ps
T <sub>PER</sub>	Output Period Jitter (rms) <sup>[12]</sup>	660 MHz <sup>[11]</sup>	-	1.6	ps
tsk <sub>(P)</sub>	Output Pulse Skew <sup>[13]</sup>	660 MHz <sup>[11]</sup> , See Figure 3	-	35	ps
T <sub>R</sub> , T <sub>F</sub>	Output Rise/Fall Time (see Figure 2)	660 MHz 50% duty cycle Differential 20% to 80%	0.08	0.3	ns

**Notes:**

11. 50% duty cycle; standard load; differential operation

12. For 3.3V supplies. Jitter measured differentially using an Agilent 8133A Pulse Generator with an 8500A LeCroy Wavemaster Oscilloscope using at least 10,000 data points

13. Output pulse skew is the absolute difference of the propagation delay times: | t<sub>PLH</sub> - t<sub>PHL</sub> |

Timing Definitions

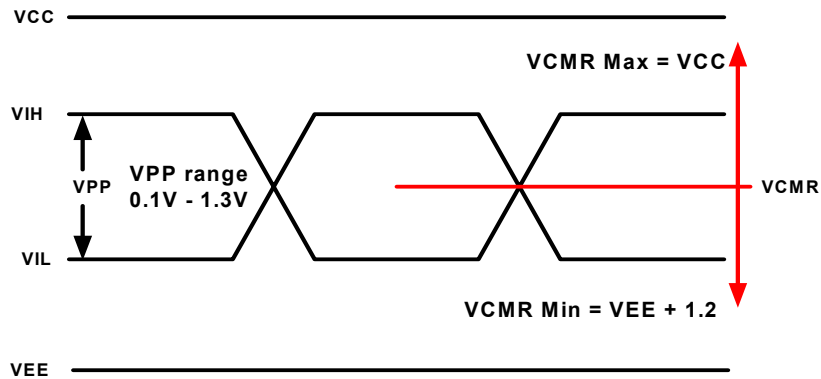

Figure 1. PECL/ECL Input Waveform Definitions

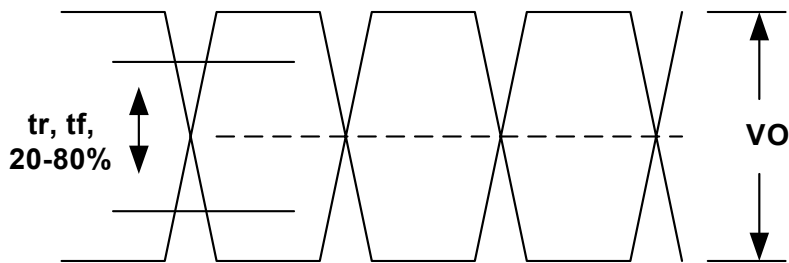

Figure 2. ECL/LVPECL Output

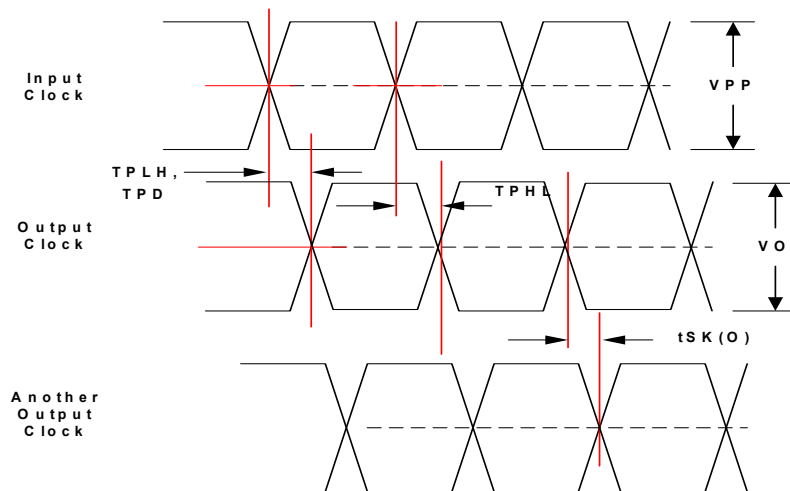
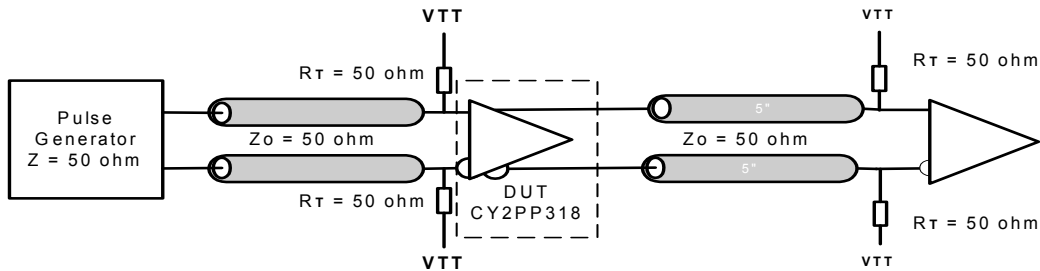

Figure 3. Propagation Delay ( $T_{PD}$ ), output pulse skew ( $|t_{PLH} - t_{PHL}|$ ), and output-to-output skew ( $t_{SK(O)}$ ) for both CLKA or CLKB to Output Pair, PECL/ECL to PECL/ECL

### Test Configuration

Standard test load using a differential pulse generator and differential measurement instrument.



**Figure 4. CY2PP318 AC Test Reference**

### Applications Information

#### Termination Examples

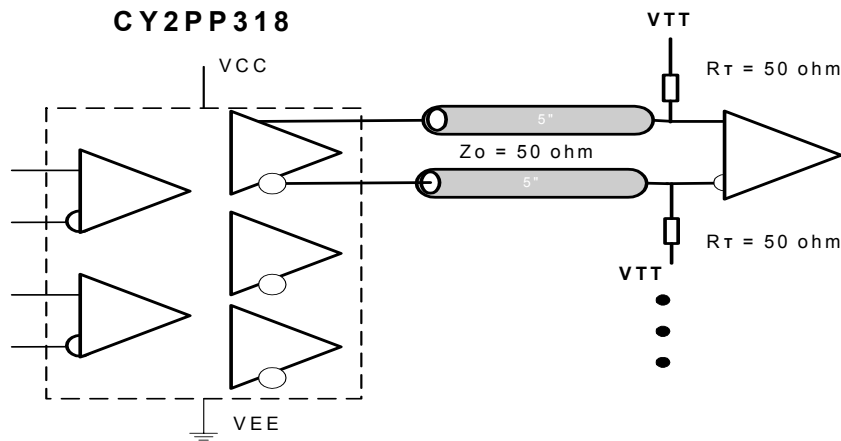

**Figure 5. Standard LVPECL – PECL Output Termination**

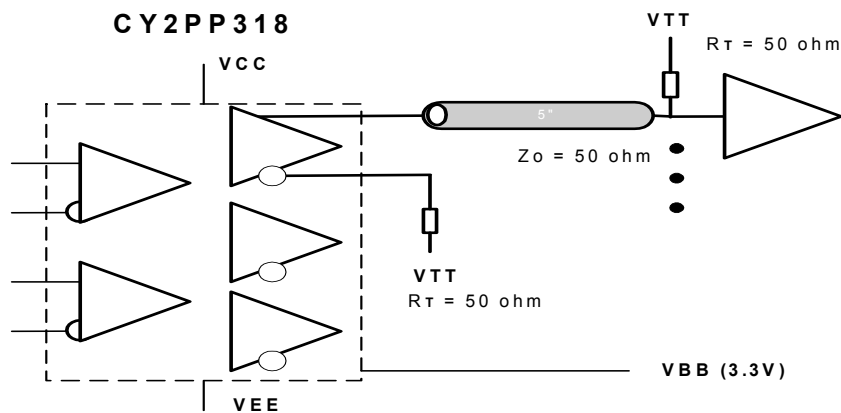

**Figure 6. Driving a PECL/ECL Single-ended Input**

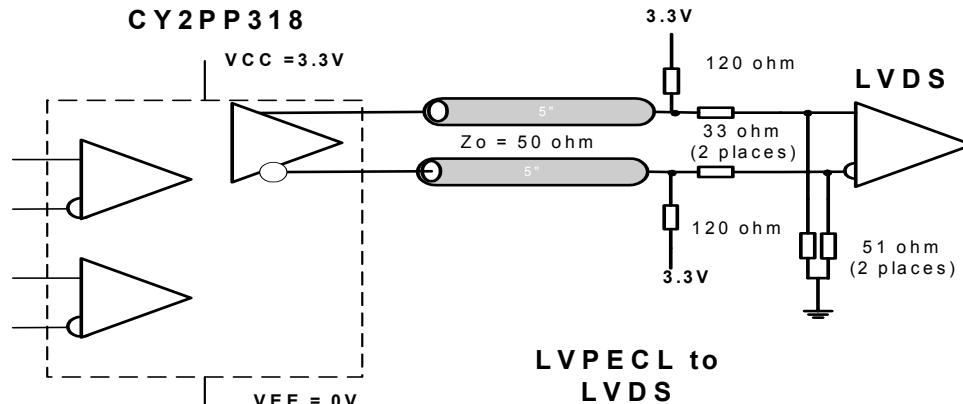

Figure 7. Low-voltage Positive Emitter-coupled Logic (LVPECL) to a Low-voltage Differential Signaling (LVDS) Interface

### Ordering Information

Part Number	Package Type	Product Flow
CY2PP318JI	28-pin PLCC	Industrial, -40° to 85°C
CY2PP318JIT	28-pin PLCC – Tape and Reel	Industrial, -40° to 85°C

### Package Drawing and Dimensions

#### 28-lead Plastic Leaded Chip Carrier J64

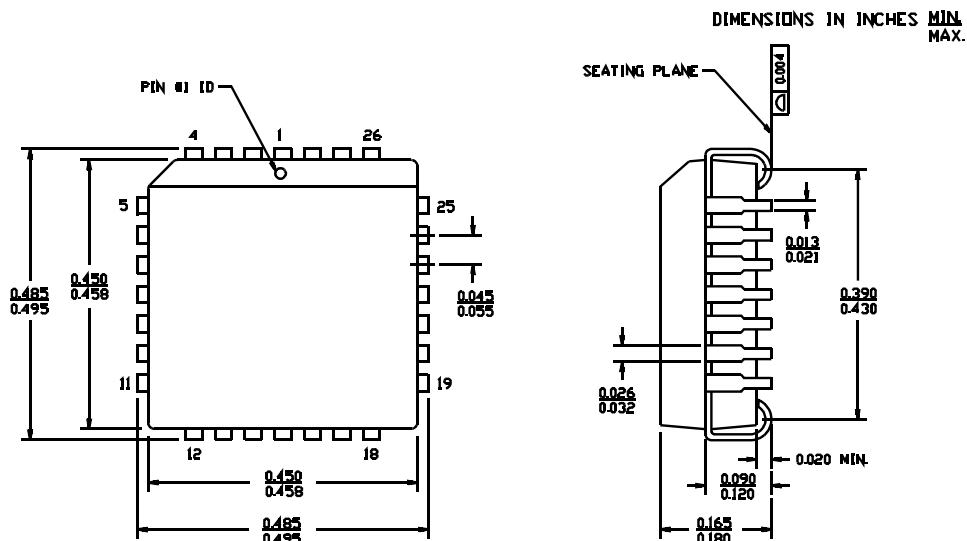

51-85001-\*A

FastEdge is a trademark of Cypress Semiconductor. All product and company names mentioned in this document are the trademarks of their respective holders.



Document History Page

Document Title: CY2PP318 FastEdge™ Series 1 of 2:8 Differential Clock/Data Fanout Buffer				
Document Number: 38-07501				
REV.	ECN NO.	Issue Date	Orig. of Change	Description of Change
**	122041	02/13/03	RGL	New Data Sheet
*A	125923	06/11/03	RGL	Shifted the pin location Changed the title (ComLink to FastEdge) Corrected Specs that does not match EROS/IROS
*B	204240	See ECN	RGL	Change pin 1 from VCC to VCCO
*C	222602	See ECN	RGL	Changed the ECL and PECL mode ranges in the features section Specified tsk max value to 150ps Replaced I <sub>CC</sub> calculation with power calculation in the footnote. Reformatted datasheet Revised jitter spec as period jitter (rms) Max operating frequency 1.5 GHz
*D	229352	See ECN	RGL	Added JEDEC Spec for MSL
*E	247624	See ECN	RGL/GGK	Changed V <sub>OH</sub> and V <sub>OL</sub> to match with the Char Data