

1X4 RJ45 CONNECTOR MODULE WITH INTEGRATED 10/100 BASE-TX MAGNETICS

P/N: LU4T516

Feature



- RJ-45 connector integrated with X'FMR /Impedance resistor/High voltage capacitor.
- Size same as RJ-45 connector to save PCB Board space.
- Reduce EMI radiation, Improve EMI performance.
- Design for 100 BASE transmission over UTP-5 cable.
- Operating temperature range: 0°C to +70°C.
- Storage temperature range: -25°C to +125°C.

Electrical Specifications @ 25°C

Part Number	Turns Ratio (±5%)		OCL (uH Min) @ 100 KHz/0.1V with 8mA DC Bias	C _{w/w} (pF Max)	L.L (uH Max)	Rise Time 10-90%(nSTyp)	Insertion Loss (dB Max) 0.3-100MHz	HI-POT (Vrms)
	TX	RX						
LU4T516	1CT:1	1CT:1CT	350	28	0.4	2.5	-1.15	1500

Continue

Part Number	Return Loss (dB Min)					Cross talk (dB Min)			CMR (dB Min)		
	30MHz	40MHz	50MHz	60MHz	80MHz	0.3-30MHz	30-60MHz	60-100MHz	1-30MHz	30-60MHz	60-125MHz
LU4T516	-16	-14	-13.5	-13	-10	-40	-35	-30	-30	-25	-20

Schematic

Block Circuit x 4 set in LU4T516

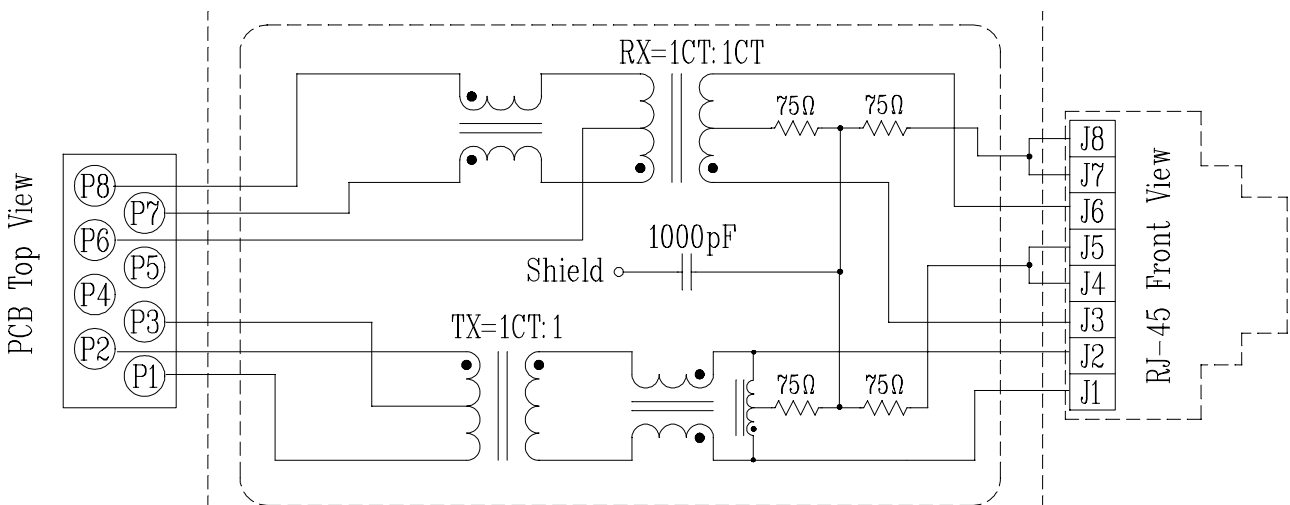

1X4 RJ45 CONNECTOR MODULE WITH INTEGRATED 10/100 BASE-TX MAGNETICS

P/N: LU4T516

Mechanical

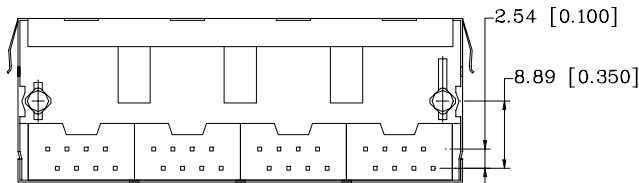
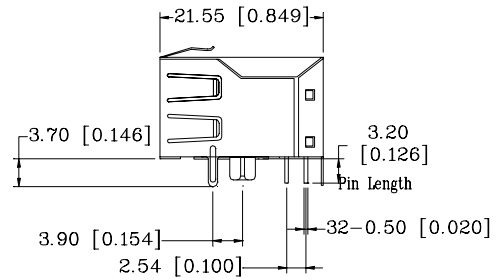
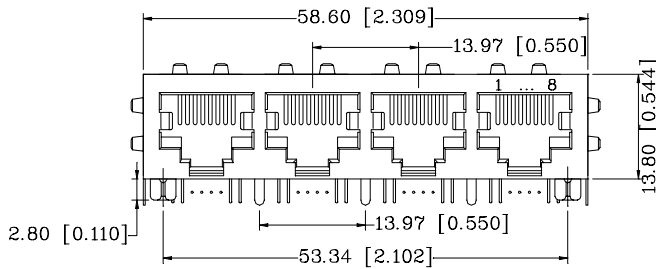
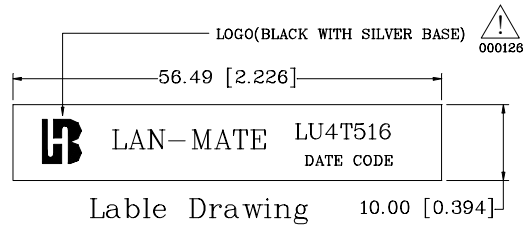
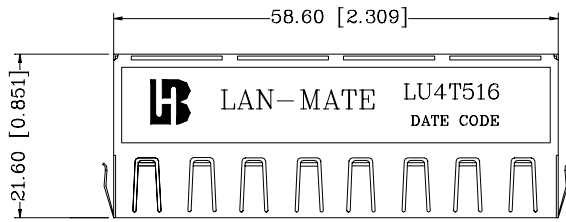

Units: mm [Inches]

Tolerances: xx.x0±0.25 [0.010]

0.xx±0.05 [0.002]

- 1. Plastic Material : PBT 15% Glass Filled(UL 94V-0), Black Housing
- 2. Metal Shield : Brass C2680-H, 20u Nickel Plated, t=0.25mm
- 3. Spring Wire : 0.45mm Dia. Phosphor bronze with 6u gold plated
- 4. Solder Pin : 0.4x0.4mm, Phosphor bronze with solder Plated
- 5. Durability : 300 Mating cycles Min.

PCB Layout Mounting Hole(Top View)

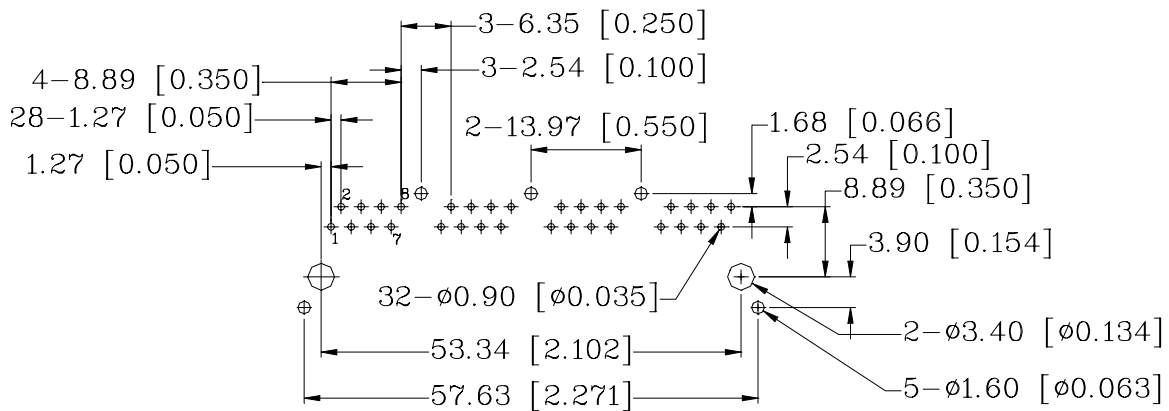

Units: mm [Inches] Tolerances: xx.x0±0.25 [0.010]

0.xx±0.05 [0.002]