



Large-Current Power Inductor
MPLCG Series
 [RoHS Compliant]



Model	Inductance (μ H) at 100kHz	DC resistance RDC(m Ω)max.	I_{rms} ^{※1} (Ref.)	Rated Current(A) I_{sat} ^{※2} (Ref.)
MPLCG0530LR22	0.22 \pm 20%	3.7	14.1	10.2
MPLCG0530LR33	0.33 \pm 20%	7.3	10.3	8.9
MPLCG0530L1R0	1.0 \pm 20%	14.6	7.4	5.6
MPLCG0530L1R5	1.5 \pm 20%	21.7	5.9	5.6
MPLCG0530L2R2	2.2 \pm 20%	36.4	4.5	5.0
MPLCG0630L1R0	1.0 \pm 20%	9.0	11.9	11.3
MPLCG0630L1R5	1.5 \pm 20%	15.0	9.9	8.3
MPLCG0630L2R2	2.2 \pm 20%	19.0	8.2	7.8
MPLCG0630L3R3	3.3 \pm 20%	30.0	6.5	6.3
MPLCG0630L4R7	4.7 \pm 20%	41.0	5.5	5.4

※1 T=40K rise at rated current. ※2 Inductance drop 20% at rated current.
 ●Operating temperature range: -20~+120°C (Include self temperature rise)

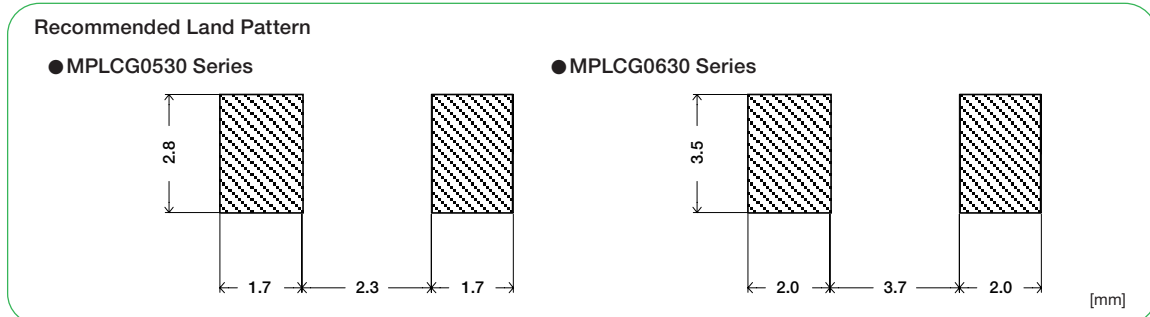
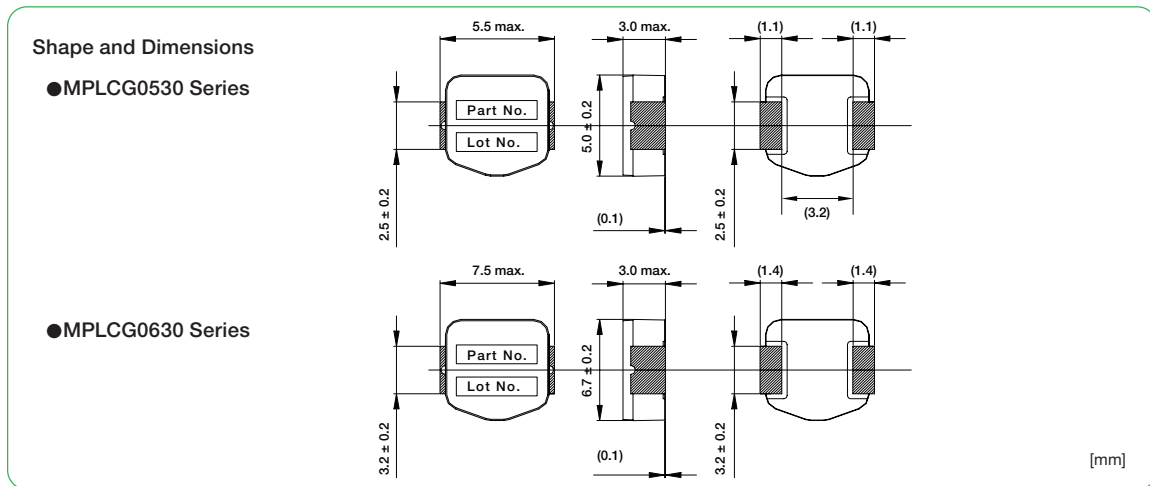

●All specifications in this catalog and production status of products are subject to change without notice. Prior to the purchase, please contact NEC TOKIN for updated product data.
 ●Please request for a specification sheet for detailed product data prior to the purchase.
 ●Before using the product in this catalog, please read "Precautions" and other safety precautions listed in the printed version catalog.

DC-Superposed Characteristics

MPLCG0530Series[LR22,LR33]

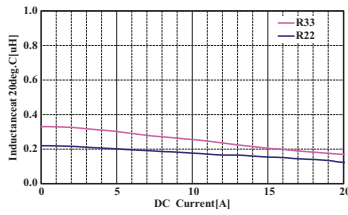

MPLCG0530Series[L1R0,L1R5,L2R2]

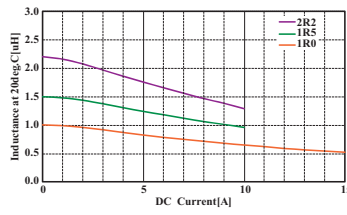

MPLCG0630Series

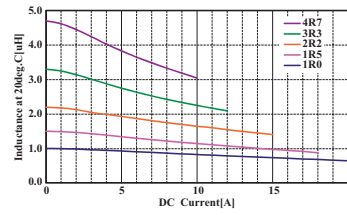

Dimensions of indented square hole plastic tape

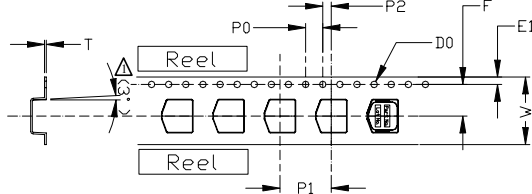

Reel dimensions

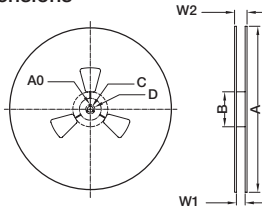

MPLCG0530 Series (3500pcs./reel)

[mm]							
W	F	E1	P1	P2	P0	φD0	T
±0.3	±0.1	±0.1	±0.1	±0.1	±0.1	±0.05	±0.05
12.0	5.5	1.75	8.0	2.0	4.0	1.55	0.4

MPLCG0630 Series (2000pcs./reel)

[mm]							
W	F	E1	P1	P2	P0	φD0	T
±0.3	±0.1	±0.1	±0.1	±0.1	±0.1	±0.05	±0.05
16.0	7.5	1.75	12.0	2.0	4.0	1.55	0.4

MPLCG0530 Series

[mm]							
A	B	C	D	A0	r	W1	W2
±5.0	±10	±1.0	±0.8	±0.5		±1.5	±2.0
φ380	φ95	φ13.5	φ21.0	2.0	R1.0	14.5	18.5

MPLCG0630 Series

[mm]							
A	B	C	D	A0	r	W1	W2
±5.0	±10	±1.0	±0.8	±0.5		±1.0	±1.5
φ380	φ95	φ13.5	φ21.0	2.0	R1.0	18.0	21.6

NEC / TOKIN NEC TOKIN Corporation

2nd Sales Unit

Chiyoda First Bldg., 8-1, Nishi-Kanda 3-chome, Chiyoda-ku, Tokyo 101-8362, Japan

1st Overseas Sales Dept.

Phone: +81-3-3515-9222 Fax: +81-3-3515-9223

2nd Overseas Sales Dept.

Phone: +81-3-3515-9224 Fax: +81-3-3515-9223

NEC TOKIN Korea Co., Ltd.

518, Korea City AIR-Terminal B/D, 159-6, Samsung-dong, Kangnam-gu, Seoul 135-728, Korea
Phone: +82-2-551-3651 Fax: +82-2-551-3650

NEC TOKIN America Inc.

(Headquarters & Western Area Sales)
2460 North First Street, Suite 220, San Jose, California 95131, U.S.A.
Phone: +1-408-324-1790 Fax: +1-408-324-1497

Chicago Branch (Northeast Sales Office)

1600 Golf Road, Corporate Center, Suite 1228, Rolling Meadows, Illinois 60008, U.S.A.
Phone: +1-847-981-5047 Fax: +1-847-981-5051

Austin Branch (Southeast Sales Office)

11782 Jollyville Road, Suite 208, Austin, Texas 78759, U.S.A.
Phone: +1-512-219-4040 Fax: +1-512-219-4007

NEC TOKIN Hong Kong Ltd.

Unit Nos. 1513-1517, Level 15, Tower II, Grand Central Plaza, 138 Shatin Rural Committee Road, Shatin, New Territories, Hong Kong
Phone: +852-2730-0028 Fax: +852-2375-2508

For inquiry, Please call Sales Promotion Department (Japan)

Phone: +81-3-3515-9220 Fax: +81-3-3515-9221

NEC TOKIN Shanghai Co., Ltd.

Room 301-302, Metro Plaza, No.555 Loushanguan Road, Changning District, Shanghai, China 200051
Phone: +86-21-6228-0606 Fax: +86-21-6228-6862

NEC TOKIN Singapore Pte Ltd.

150 Changi Road, #04-02 Guthrie Building, Singapore 419973
Phone: +65-6345-3181 Fax: +65-6345-6016

NEC TOKIN Taiwan Co., Ltd.

Room 411, 4F, No.9, Lane 3, Minsheng W.Road, Taipei 104, Taiwan
Phone: +886-2-2521-3998 Fax: +886-2-2521-3993

NEC TOKIN Europe GmbH

Hellersbergstrasse 14, D-41460 Neuss, Germany
Phone: +49-2131-1866-0 Fax: +49-2131-1866-18

France Branch

9, Rue Paul Dautier, 78142 Velizy-Villacoublay, France
Phone: +33-1-39-452011 Fax: +33-1-39-451209

©2012 NEC TOKIN Corporation

Technical support

NEC TOKIN EMC Division Sales and Marketing Department
phone: +81-3-3515-9260 Fax: +81-3-3515-9278

Precautions



- The names of the products and the specifications in this catalog are subject to change without notice for the sake of improvement. The manufacturer also reserves the right to discontinue any of these products. At the time of delivery, please ask for specification sheets to check the contents in order to use the products properly and safely.
- Descriptions in this catalog regarding product characteristics and quality are based solely on discrete components. When using these components, be sure to check the specifications with the component in question mounted on the products.
- The manufacturer's warranty will not cover any disadvantage or damage caused by improper use of the products that deviates from the characteristics, specifications, or conditions for use described in this catalog.
- The products in this catalog are intended for use in ordinary electronic products. If any of these products are to be used in special applications requiring extremely high reliability, such as in aviation equipment and nuclear power controllers where product defects might pose a safety risk, please consult your NEC TOKIN sales representatives.
- Though the manufacturer has taken all possible precautions to ensure the quality and reliability of its products, improper use of products may result in bodily injury, fire, or similar accident. If you have any questions regarding the use of the products in question, please consult your NEC TOKIN sales representatives.
- Please be advised that the manufacturer accepts no responsibility for any infringement by users of the manufacturer's products on third party patents or industrial copyrights. The manufacturer is responsible only when such infringements are attributable to the structural design of the product and its manufacturing process.
- Export Control
For customers outside Japan
NEC TOKIN products should not be used or sold for use in the development, production, stockpiling or utilization of any conventional weapons or mass-destructive weapons (nuclear weapons, chemical or biological weapons, or missiles), or any other weapons.
- For customers in Japan
For products which are controlled items subject to the "Foreign Exchange and Foreign Trade Law" of Japan, the export license specified by the law is required for export.
- This catalog is current as of May 2012.

<http://www.nec-tokin.com>

9631MLGVOL03E1205E0
Printed in Japan



- All specifications in this catalog and production status of products are subject to change without notice. Prior to the purchase, please contact NEC TOKIN for updated product data.
- Please request for a specification sheet for detailed product data prior to the purchase.
- Before using the product in this catalog, please read "Precautions" and other safety precautions listed in the printed version catalog.