

Ambient Light Sensor ICs

Digital 16bit Serial Output Type Ambient Light Sensor IC



BH1730FVC

No.11046EAT13

●Descriptions

BH1730FVC is a digital Ambient Light Sensor IC for I²C bus interface. This IC is the most suitable to obtain the ambient light data for adjusting LCD backlight power of TV, mobile phone. It is possible to detect very wide range light intensity. (0.008 - 65535 lx).

●Features

- 1) I²C bus Interface (f / s Mode Support, Slave address "0101001".)
- 2) There are two outputs that peaks of a spectrum response are in visible light (Type0) and in infrared light (Type1).
- 3) Illuminance to Digital Converter
- 4) Very wide range and High resolution. (0.008 - 65535 lx)
- 5) Low Current by power down function
- 6) 50Hz / 60Hz light noise reject-function
- 7) Correspond to 1.8V logic input interface
- 8) Light source dependency is little by calculating with Type0 and Type1.
(ex. Incandescent Lamp. Fluorescent Lamp. Halogen Lamp. White LED. Sun Light)
- 9) Interrupt function is available.
- 10) Adjustable measurement result for influence of optical window
(It is possible to detect min. 0.001 lx, max. 100000 lx by using this function.)
- 11) Small measurement variation (+/- 15%)
- 12) Built in power on reset circuit.

●Applications

LCD TV, Mobile phone, NOTE PC, Portable game machine, Digital camera, Digital video camera, PDA, LCD display

●Absolute Maximum Ratings

Parameter	Symbol	Limits	Units
Supply Voltage	V _{CCmax}	4.5	V
INT, SDA, DVI, SCL, Terminal Voltage	V _{INTmax} , V _{SDAmax} , V _{DVImax} , V _{SCLmax}	7	V
Operating Temperature	T _{opr}	-40~70	°C
Storage Temperature	T _{stg}	-40~100	°C
SDA, INT Sink Current	I _{max}	7	mA
Power Dissipation	P _d	260*	mW

* 70mm × 70mm × 1.6mm glass epoxy board. Derating is done at 3.47mW/°C for operating above Ta=25°C.

●Operating Conditions

Parameter	Symbol	Min.	Typ.	Max.	Units
VCC Voltage	V _{CC}	2.4	3.0	3.6	V
I ² C Reference Voltage	V _{DVI}	1.65	-	V _{CC}	V

●Electrical Characteristics (Vcc = 3.0V, Vdvi = 3.0V, Ta = 25°C, unless otherwise noted)

Parameter	Symbol	Limits			Units	Conditions
		Min.	Typ.	Max.		
Supply Current	lcc1	—	150	200	μA	Ev = 100 lx ※1 CONTROL register(00h) = "03h" and the other registers are default.
Powerdown Current	lcc2	—	0.85	1.5	μA	No input Light All registers are default.
Peak Wave Length in Type0	λp0	—	600	—	nm	Visible light response
Peak Wave Length in Type1	λp1	—	840	—	nm	Infrared light response
ADC count value in Type0	D1k_0	1020	1200	1380	count	EV = 1000 lx ※1 TIMING register(01h) = "DAh" GAIN register(07h) = "00h"
ADC count value in Type1	D1k_1	153	180	207	count	EV = 1000 lx ※1 TIMING register(01h) = "DAh" GAIN register(07h) = "00h"
Dark (0 lx) Sensor out in Type0	S0_0	0	0	2	count	No input Light TIMING register(01h) = "DAh" GAIN register(07h) = "00h"
Dark (0 lx) Sensor out in Type1	S0_1	0	0	2	count	No input Light TIMING register(01h) = "DAh" GAIN register(07h) = "00h"
Gain X1 resolution in Type0	rG1	—	0.83	—	lx/count	TIMING register(01h) = "DAh" ※1
Gain X2 resolution in Type0	rG2	—	0.42	—	lx/count	TIMING register(01h) = "DAh" ※1
Gain X64 resolution in Type0	rG64	—	0.014	—	lx/count	TIMING register(01h) = "DAh" ※1
Gain X128 resolution in Type0	rG128	—	0.007	—	lx/count	TIMING register(01h) = "DAh" ※1
Measurement Time	tmt1	—	100	150	ms	TIMING register(01h) = "DAh"
Incandescent / Fluorescent ratio by calculating with Type0 and Type1	rIF	—	1	—	times	EV = 1000 lx
INT Output 'L' Voltage	VINT	0	—	0.4	V	IINT = 3 mA
DVI Input 'L' Voltage	VDVL	—	—	0.4	V	
SCL, SDA Input 'H' Voltage 1	VIH1	0.7*DVI	—	—	V	DVI ≥ 1.8V
SCL, SDA Input 'H' Voltage 2	VIH2	1.26	—	—	V	1.65V ≤ DVI < 1.8V
SCL, SDA Input 'L' Voltage 1	VIL1	—	—	0.3*DVI	V	DVI ≥ 1.8V
SCL, SDA Input 'L' Voltage 2	VIL2	—	—	DVI-1.26	V	1.65V ≤ DVI < 1.8V
SCL, SDA, INT Input 'H' Current	IIH	—	—	10	μA	
SCL, SDA, INT Input 'L' Current	IIL	—	—	10	μA	
I ² C SCL Clock Frequency	fSCL	—	—	400	kHz	
I ² C Bus Free Time	tBUF	1.3	—	—	μs	
I ² C Hold Time (repeated) START Condition	tHDSTA	0.6	—	—	μs	
I ² C Set up time for a Repeated START Condition	tSUSTA	0.6	—	—	μs	
I ² C Set up time for STOP Condition	tSUSTO	0.6	—	—	μs	
I ² C Data Hold Time	tHDDAT	0	—	0.9	μs	
I ² C Data Setup Time	tSUDAT	100	—	—	ns	
I ² C 'L' Period of the SCL Clock	tLOW	1.3	—	—	μs	
I ² C 'H' Period of the SCL Clock	tHIGH	0.6	—	—	μs	
I ² C SDA Output 'L' Voltage	VOL	0	—	0.4	V	IOL = 3 mA

※1 White LED is used as optical source.

●Reference Data

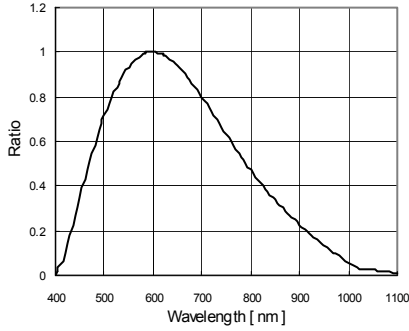

Fig.1 Spectral Response of Type0 (visible light peak)

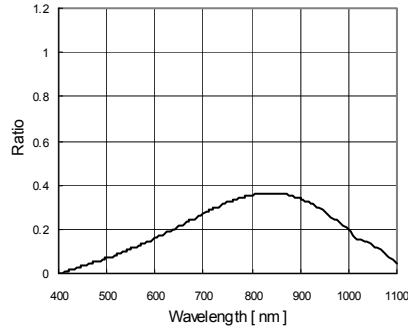

Fig.2 Spectral Response of Type1 (infrared light peak)

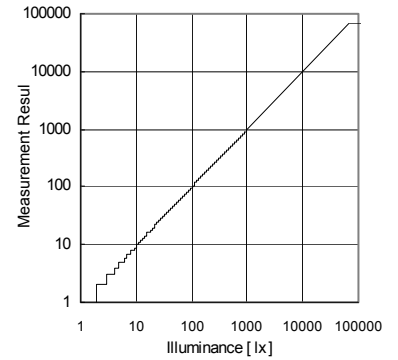

Fig.3 Illuminance -Measurement Result of Type0, Gain 1X, ITIME=DAh

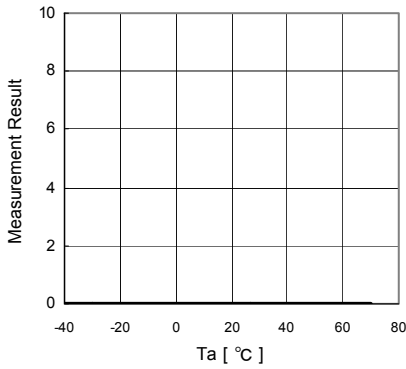

Fig.4 Dark Response of Type0

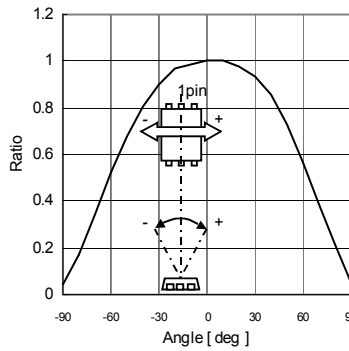

Fig.5 Directional Characteristics 1

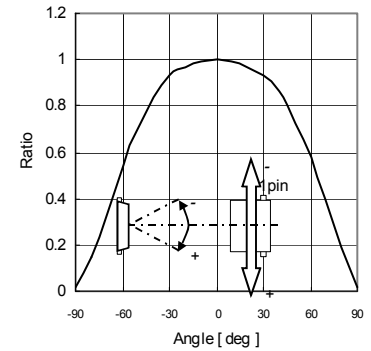

Fig.6 Directional Characteristics 2

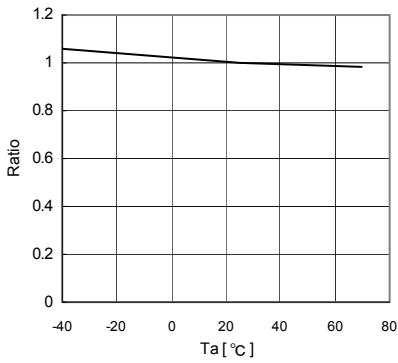

Fig.7 ADC count value in Type0 Temperature Dependency

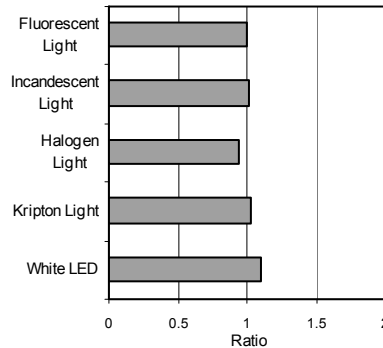

Fig.8 Light Source Dependency in calculation from Type0 and Type1. (Fluorescent Light is set to '1')

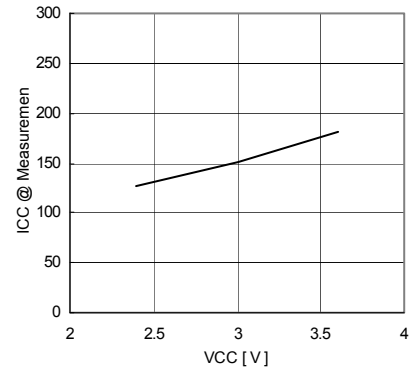

Fig.9 VCC - ICC (During measurement)

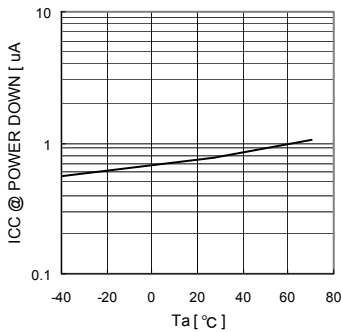

Fig.10 Power down ICC@0Lx Temperature Dependency

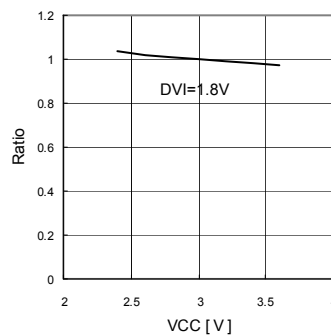

Fig.11 Measurement Result VCC Dependency

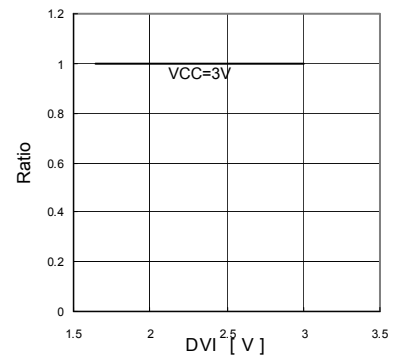
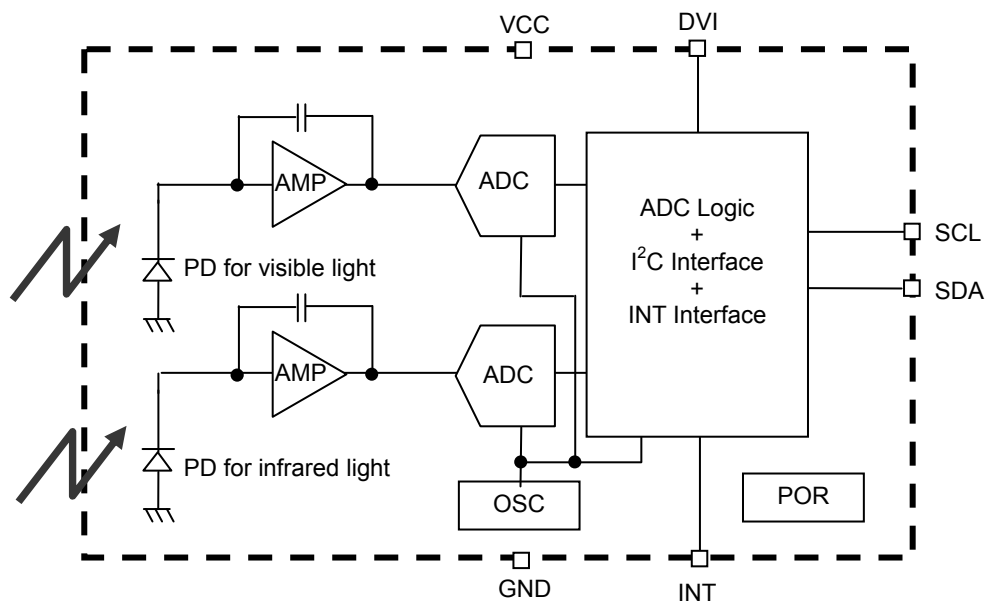

Fig.12 Measurement Result DVI Dependency

●Block Diagram



●Block Diagram Descriptions

- PD
Photo diodes (PD) with peaks in visible light and in infrared light.
- AMP
Integration OPAMP for converting from PD current to voltage.
- ADC
AD converter for obtainment digital 16bit data.
- ADC Logic + I²C Interface + INT Interface
Ambient light calculation logic and I²C Bus Interface and Interrupt function Interface.
- OSC
Internal oscillator (typ. 360kHz). It is clock for internal logic.
- POR
Power on reset. All register is reset after VCC is supplied. Please refer P14 (Caution of power on reset function).

● I²C Bus Access and Write / Read format

1) I²C Bus interface timing chart

Write measurement command and Read measurement result are done by I²C Bus interface. Please refer the formally specification of I²C Bus interface, and follow the formally timing chart.

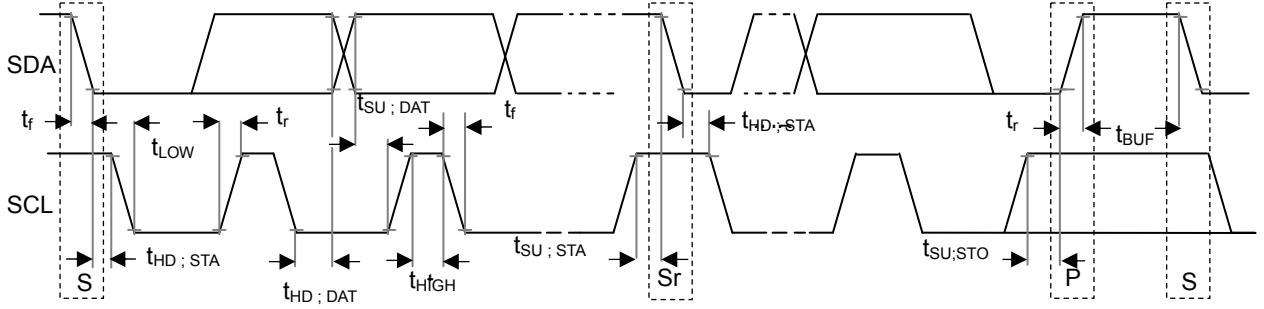

2) Main write Format

1. Case of "Write to Command Register"

ST	Slave Address 0101001	W 0	ACK	Data to Command Register 1XXXXXXX	ACK	SP
----	--------------------------	--------	-----	--------------------------------------	-----	----

2. Case of "Write to Data Register"

ST	Slave Address 0101001	W 0	ACK	Data specified at register address field 0XXXXXXX	ACK
----	--------------------------	--------	-----	--	-----

Data specified at register address field +1	ACK	...	ACK	Data specified at register address field +N	ACK	SP
---	-----	-----	-----	---	-----	----

※ The register address that set in Command register is used.

3. Case of "write to data register after write to Command Register"

ST	Slave Address 0101001	W 0	ACK	Data to Command Register 1XXXXXXX	ACK
----	--------------------------	--------	-----	--------------------------------------	-----

Data specified at register address field	ACK	...	ACK	Data specified at register address field +N	ACK	SP
--	-----	-----	-----	---	-----	----

3) Main read Format

ST	Slave Address 0101001	R 1	ACK	Data specified at register address field	ACK
----	--------------------------	--------	-----	--	-----

Data specified at register address field +1	ACK	...	ACK	Data specified at register address field +N	NACK	SP
---	-----	-----	-----	---	------	----

※ The register address that set in Command register is used.



※ BH1730FVC operates as I²C bus slave device.
 ※ Please refer formality I²C bus specification of NXP semiconductor

BH1730FVC continues to write or read data with address increments until master issues stop condition.
 Read cycle is 00h - 01h - 02h - 03h - 04h - 05h - 06h - 07h - 12h - 14h - 15h - 16h - 17h - 00h

● Measurement Procedure

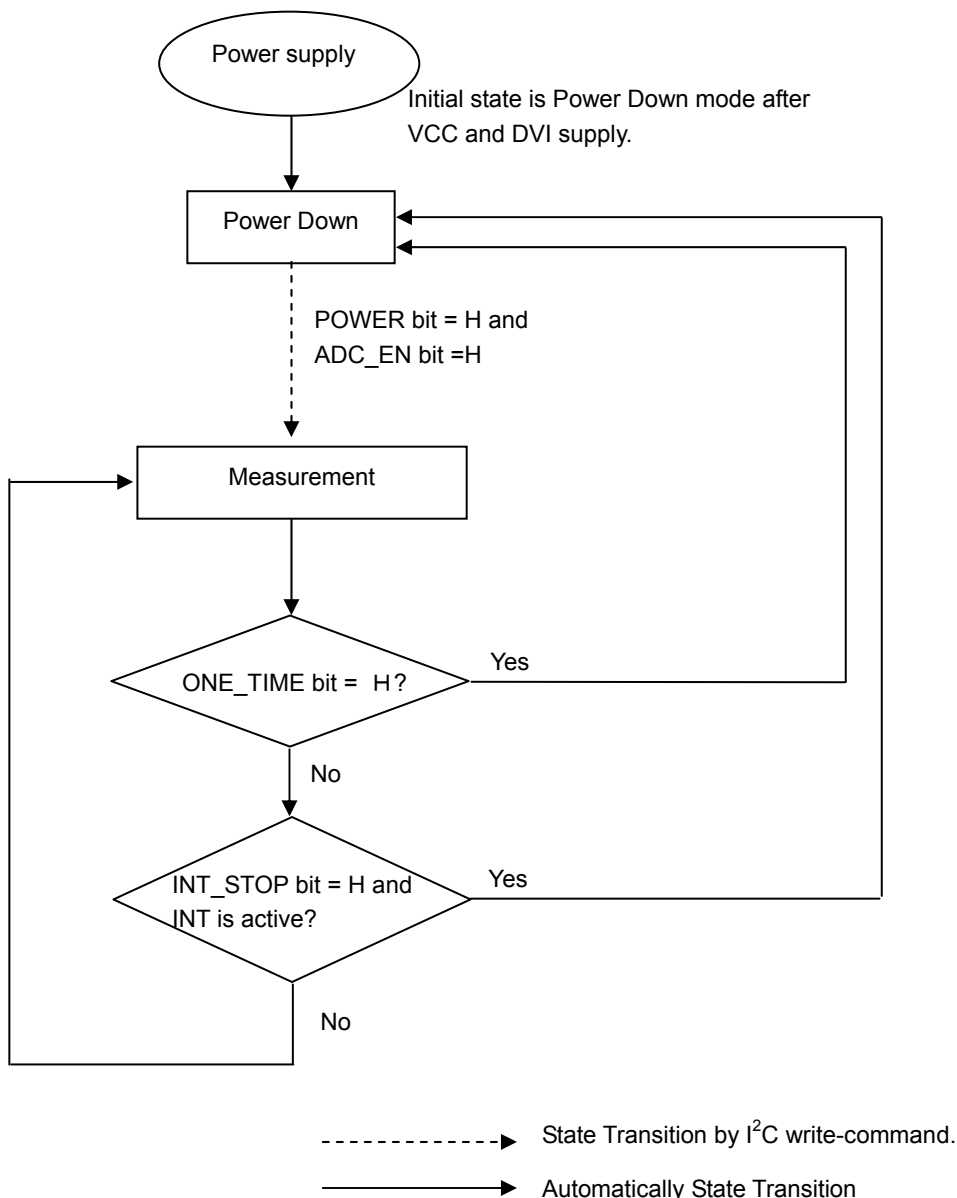

● Explanation of Asynchronous reset and Software reset command.

- 1) Asynchronous reset
 All registers are reset and BH1730FVC becomes power down during DVI = 'L'. Initial reset is not necessary, because power on reset function is included in this product.
- 2) Software reset command
 All registers are reset and BH1730FVC becomes power down by Software reset command.

●Command set

Address	Type	Register name	Register function
--	W	COMMAND	Specifies register address or set special command
00h	RW	CONTROL	Operation mode control
01h	RW	TIMING	Light integration time control
02h	RW	INTERRUPT	Interrupt function control
03h	RW	THLLOW	Low byte of low interrupt threshold setting
04h	RW	THLHIGH	High byte of low interrupt threshold setting
05h	RW	THHLOW	Low byte of high interrupt threshold setting
06h	RW	THHHIGH	High byte of high interrupt threshold setting
07h	RW	GAIN	Gain control
12h	R	ID	Part number and Revision ID
14h	R	DATA0LOW	ADC Type0 low byte data register
15h	R	DATA0HIGH	ADC Type0 high byte data register
16h	R	DATA1LOW	ADC Type1 low byte data register
17h	R	DATA1HIGH	ADC Type1 high byte data register

○COMMAND

7	6	5	4	3	2	1	0
CMD	TRANSACTION		ADDRESS / Special command				

default value 00h

Field	Bit	Type	Description
CMD	7	W	Write 1
TRANSACTION	6 : 5	W	00 : COMMAND<4:0> is ADDRESS field. 01 : Reserved. 10 : Reserved. 11 : COMMAND<4:0> is Special command field.
ADDRESS	4 : 0	W	Specify register address. Don't specify invalid register address.
Special command			00001 : Interrupt output reset. 00010 : Stop manual integration mode. 00011 : Start manual integration mode. 00100 : Software reset Don't input other commands.

OCONTROL (00h)

7	6	5	4	3	2	1	0
RES		ADC_ INTR	ADC_ VALID	ONE_ TIME	DATA_ SEL	ADC_ EN	POWER

default value 00h

Field	Bit	Type	Description
RES	7: 6	RW	Write 00
ADC_INTR	5	R	0 : Interrupt is inactive. 1 : Interrupt is active.
ADC_VALID	4	R	0 : ADC data is not updated after last reading. 1 : ADC data is updated after last reading.
ONE_TIME	3	RW	0 : ADC measurement is continuous. 1 : ADC measurement is one time. ADC changes to power down automatically.
DATA_SEL	2	RW	0 : ADC measurement Type0 and Type1. 1 : ADC measurement Type0 only.
ADC_EN	1	RW	0 : ADC measurement is not started. 1 : ADC measurement is started.
POWER	0	RW	0 : ADC power down. 1 : ADC power on.

OTIMING (01h)

7	6	5	4	3	2	1	0
ITIME							

default value DAh

Field	Bit	Type	Description
ITIME	7 : 0	RW	ADC Light Integration time control. 00000000 : Use manual integration mode. 11111111 : 1 cycle. 2.7ms. 11111110 : 2 cycle. 5.4ms. 11101101 : 19 cycle. 51.3ms. 11011010 : 38 cycle. 102.6ms. 10110110 : 74 cycle. 199.8ms. 01101100 : 148 cycle. 399.6ms. 00000001 : 255 cycle. 688.5ms. Cycle is defined 256-ITIME<7:0>. Integration time is typically cycle*2.7ms. ADC needs additional 2ms for internal calculation.

OINTERRUPT (02h)

7	6	5	4	3	2	1	0
RES	INT_STOP	RES	INT_EN	PERSIST			

default value 00h

Field	Bit	Type	Description
RES	7	RW	Write 0.
INT_STOP	6	RW	0 : ADC measurement is continuous. 1 : ADC measurement is stopped and ADC becomes power down state when interrupt becomes active.
RES	5	RW	Write 0.
INT_EN	4	RW	0 : Interrupt function is invalid. 1 : Interrupt function is valid.
PERSIST	3 : 0	RW	Interrupt persistence function. 0000 : Interrupt becomes active at each measurement end. 0001 : Interrupt status is updated at each measurement end. 0010 : Interrupt status is updated if two consecutive threshold judgments are the same. When set 0011 or more, interrupt status is updated if threshold judgments are the same over consecutive set times.

OTH_LOW (03h,04h)

7	6	5	4	3	2	1	0
Lower threshold data							

default value 00h

Register	Address	Bit	Type	Description
TH lower LSBs	03h	7 : 0	RW	Lower byte
TH lower MSBs	04h	7 : 0	RW	Upper byte

OTH_UP (05h,06h)

7	6	5	4	3	2	1	0
Upper threshold data							

default value FFh

Register	Address	Bit	Type	Description
TH upper LSBs	05h	7 : 0	RW	Lower byte
TH upper MSBs	06h	7 : 0	RW	Upper byte

OGAIN (07h)

7	6	5	4	3	2	1	0
RES				GAIN			

default value 00h

Field	Bit	Type	Description
RES	7 : 3	RW	Write 00000.
GAIN	2 : 0	RW	Change ADC resolution. X00 : X1 gain mode X01 : X2 gain mode X10 : X64 gain mode X11 : X128 gain mode

OPART_ID (12h)

7	6	5	4	3	2	1	0
Part Number				Revision ID			

default value 7Xh

Field	Bit	Type	Description
Part number	7 : 4	R	0111
Revision ID	3 : 0	R	XXXX

ODATA0 (14h,15h)

7	6	5	4	3	2	1	0
ADC Type0 data							

default value 00h

Register	Address	Bit	Type	Description
DATA0 LSBs	14h	7 : 0	R	Lower byte
DATA0 MSBs	15h	7 : 0	R	Upper byte

ODATA1 (16h,17h)

7	6	5	4	3	2	1	0
ADC Type1 data							

default value 00h

Register	Address	Bit	Type	Description
DATA1 LSBs	16h	7 : 0	R	Lower byte
DATA1 MSBs	17h	7 : 0	R	Upper byte

● Measurement sequence example from "Write to start measurement" to "Read measurement result"



from Master to Slave



from Slave to Master

① Send "Continuous measurement mode" instruction

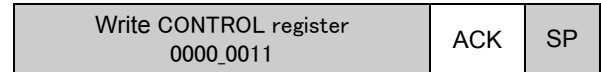

② Wait to complete 1st measurement. TIMING=DAh (typ. 100ms, max.150ms) and GAIN=00h (X1 Gain) at default.

③ Read measurement result.

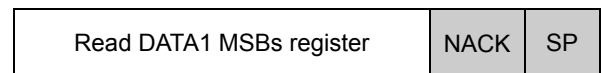
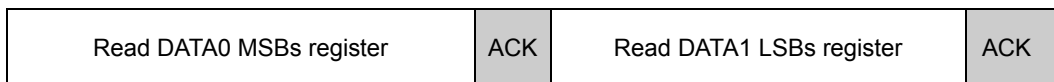
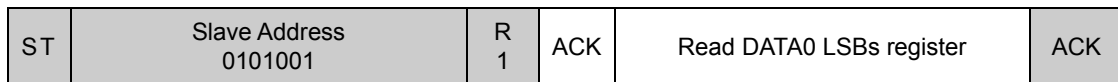
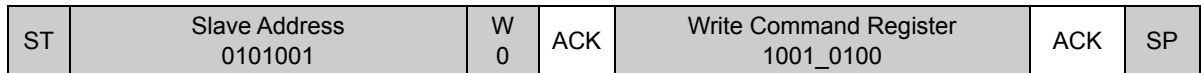

● Application circuit example

If you don't use INT Pin, please connect to GND or open.

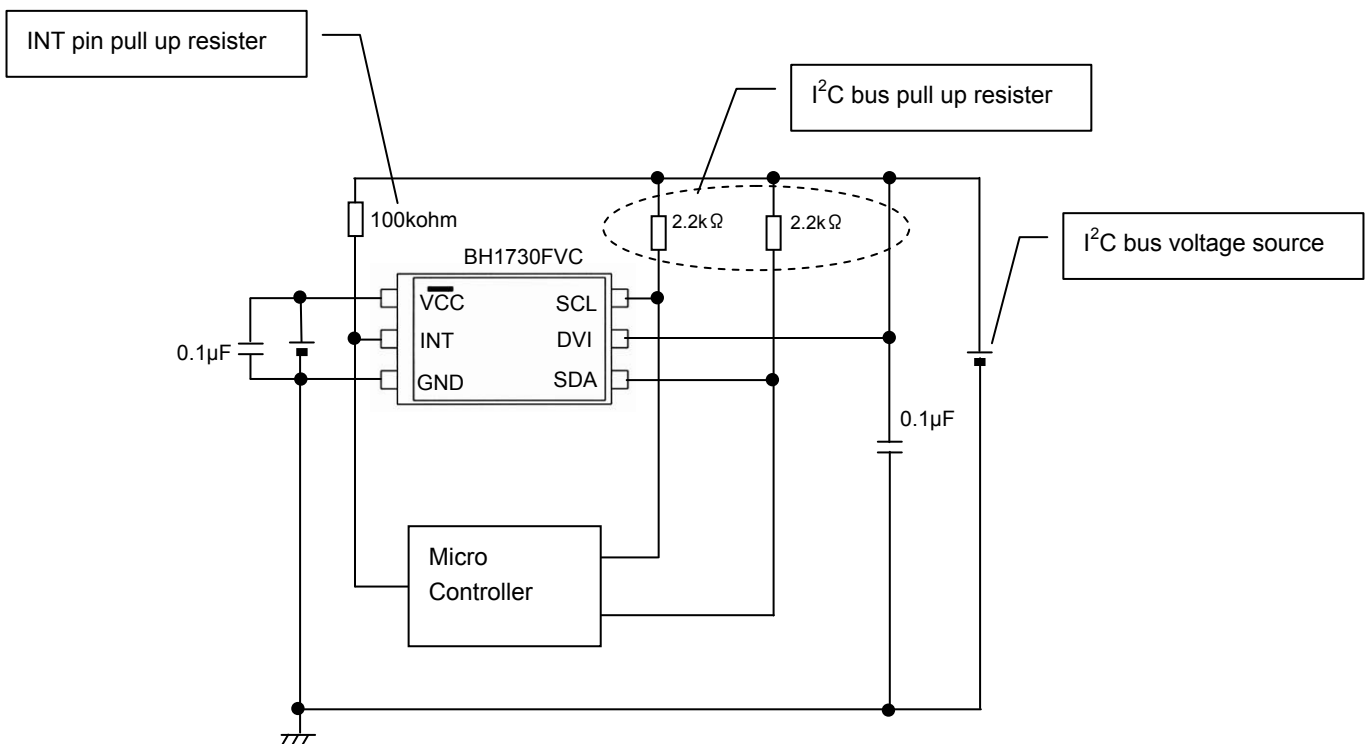

●Lux calculation from DATA0 and DATA1

BH1730FVC has two outputs, DATA0 (14h, 15h) for detecting visible light and infrared light, and DATA1 (16h, 17h) for detecting infrared light. Lux value can be calculated by using these two outputs. The calculation formula depends on the characteristic of optical window. The example of the calculation is shown as follows.

Ex) No optical window or optical window that has flat transmittance from visible light to infrared light.

```
if (DATA1/DATA0<0.26)      Lx = ( 1.290*DATA0 - 2.733*DATA1 ) / Gain * 100ms / ITIME
else if (DATA1/DATA0<0.55) Lx = ( 0.795*DATA0 - 0.859*DATA1 ) / Gain * 100ms / ITIME
else if (DATA1/DATA0<1.09) Lx = ( 0.510*DATA0 - 0.345*DATA1 ) / Gain * 100ms / ITIME
else if (DATA1/DATA0<2.13) Lx = ( 0.276*DATA0 - 0.130*DATA1 ) / Gain * 100ms / ITIME
else                        Lx=0
```

● Interrupt function

Interrupt function compares measurement result to preset interrupt threshold level. BH1730FVC uses two threshold level (upper and lower). If measurement result is outside of two threshold, INT pin outputs 'L'. Interrupt threshold is defined at Interrupt threshold registers (03h - 06h).

Interrupt function is able to control by Interrupt opcode. Interrupt persistence is defined at Interrupt opcode lower 4 bits. INT pin is Nch open drain terminal so this terminal should be pull-up to some kind of voltage source by an external resistor. Maximum sink current rating of this terminal is 7mA.

INT terminal is high impedance when VCC is supplied.

INT terminal becomes inactive by setting "Interrupt output reset" special command. VCC current (approximately 30uA at VCC=3.0V) is consumed during INT terminal is 'L'. So it is recommended to reset INT terminal at once when interrupt is detected.

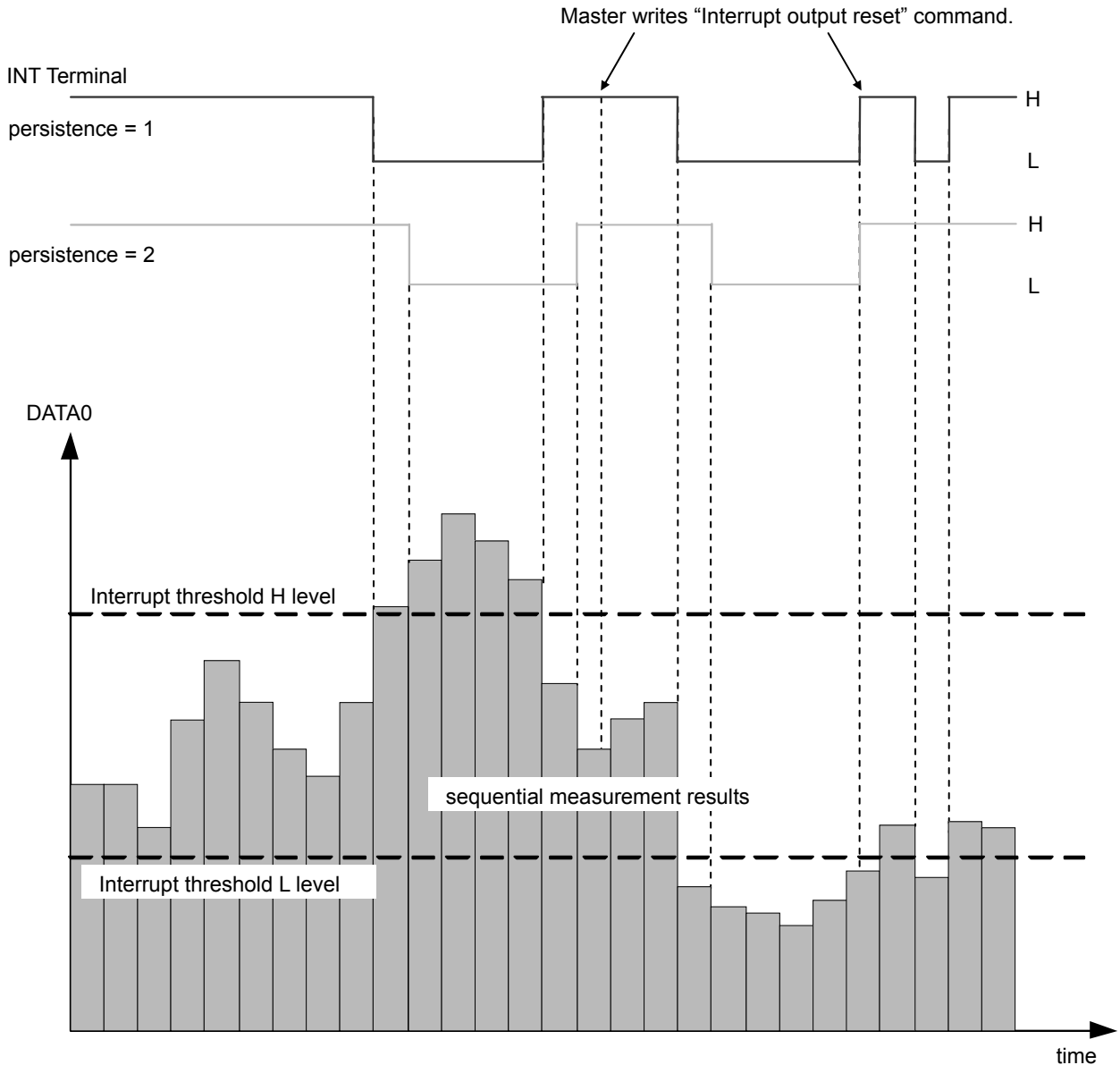

●Caution of power on reset function

BH1730FVC has power on reset (POR) function. POR is to reset all register and flip flop when VCC Power supplies. There is some cautions about power on and down sequence seeing in below.

- ① Power on time : t_1
More than 2ms is need to active BH1730FVC after VCC supplies more than 2.0V from VCC is less than 0.4V.
- ② Power off time : t_2
More than 1ms ($V_{CC} < 0.4V$) is need to active BH1730FVC.

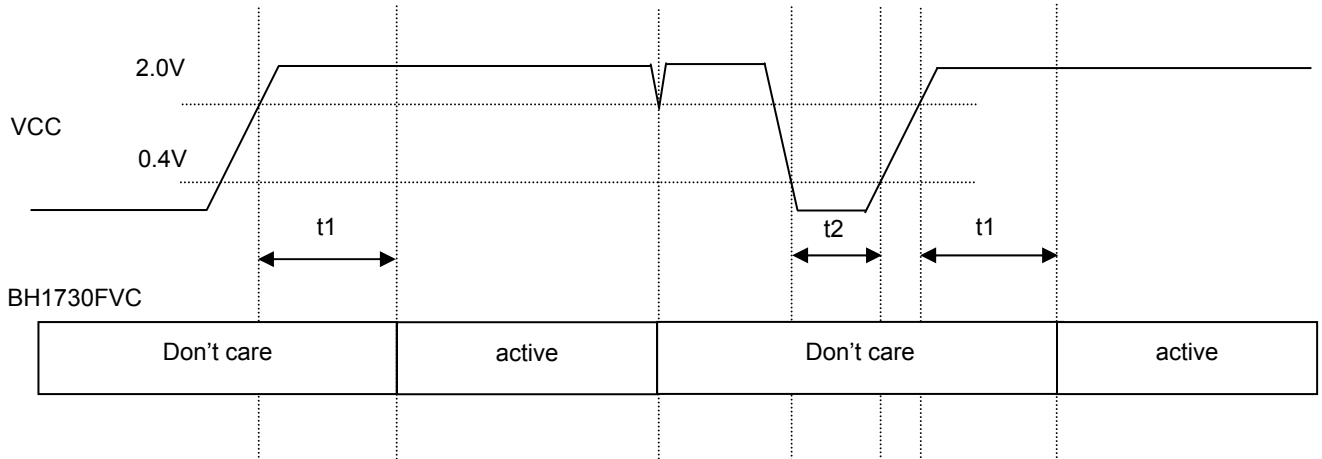

**"active state" is that BH1730FVC works and accept I²C bus access correctly.

●ALS sensitivity adjustment function

BH1730FVC is possible to change ALS sensitivity. And it is possible to cancel the optical window influence (difference with / without optical window) by using this function. Adjustment is done by changing measurement time. For example, when transmission rate of optical window is 50% (measurement result becomes 0.5 times if optical window is set), influence of optical window is ignored by changing sensor sensitivity from default to 2 times.

Sensitivity can be adjusted by ITIME (01h<7:0>). The measurement time is proportional to “256- ITIME”. For example, sensitivity is twice when “256- ITIME” is twice, and the measurement time is twice, too.

The range of adjusting TIMING is below.

	Min.	Typ.	Max.
Sensitivity	Default*0.026	Default	Default*6.711
range of TIMING (binary)	1111_1111	1101_1010	0000_0001
range of TIMING (decimal)	255	218	1
Measurement time	2.7ms	102.6ms	688.5ms

It is possible to detect 0.001 lx by using this function at GAIN = x128.

The below formula is to calculate illuminant per 1 count.

$$\text{Illuminant per 1 count in Type0 at GAIN} = x1(\text{lx / count}) = 1 / 1.2 * (256 - 218) / (256 - X)$$

218 : Default value of ITIME (decimal)
X : ITIME value (decimal)

$$\text{Illuminant per 1 count in Type0 at GAIN} = x128(\text{lx / count}) = 1 / 1.2 * (256 - 218) / (256 - X) / 128$$

218 : Default value of ITIME (decimal)
X : ITIME value (decimal)
128 : Gain value

Illuminant per 1 count in Type0 at GAIN = x1 is as following within adjustable range of ITIME.

ITIME value	Illuminant per 1count(lx / count)
1111_1111	31.67
1101_1010	0.833
0000_0001	0.124

Illuminant per 1 count in Type0 at GAIN = x128 is as following within adjustable range of ITIME.

ITIME value	Illuminant per 1count(lx / count)
1111_1111	0.247
1101_1010	0.007
0000_0001	0.001

Please take care that about 100,000lx or more cannot be measured even if decreasing the sensitivity.

●Terminal Description

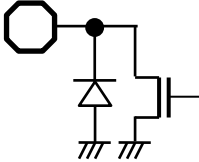
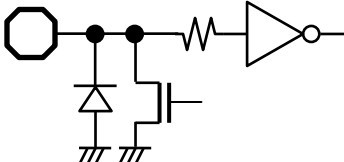
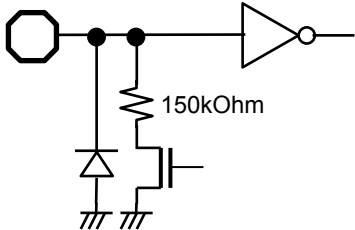
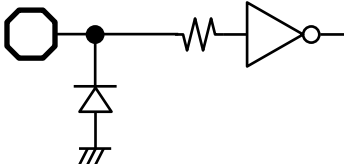
PIN No.	Terminal Name	Equivalent Circuit	Function
1	VCC		Power supply terminal
2	INT		INT Pin output terminal. If you don't use INT Pin, please connect to GND or open.
3	GND		GND terminal
4	SDA		I ² C bus Interface SDA terminal
5	DVI		SDA, SCL reference voltage terminal and asynchronous reset terminal for internal registers. Initial reset is not necessary, because power on reset function is included in this product. DVI terminal is pulled down by 150kOhm while DVI is set 'L'
6	SCL		I ² C bus Interface SCL terminal

※These values are design-value, not guaranteed.

●Package Outlines

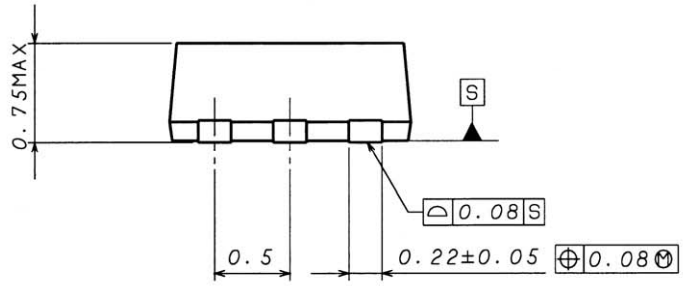
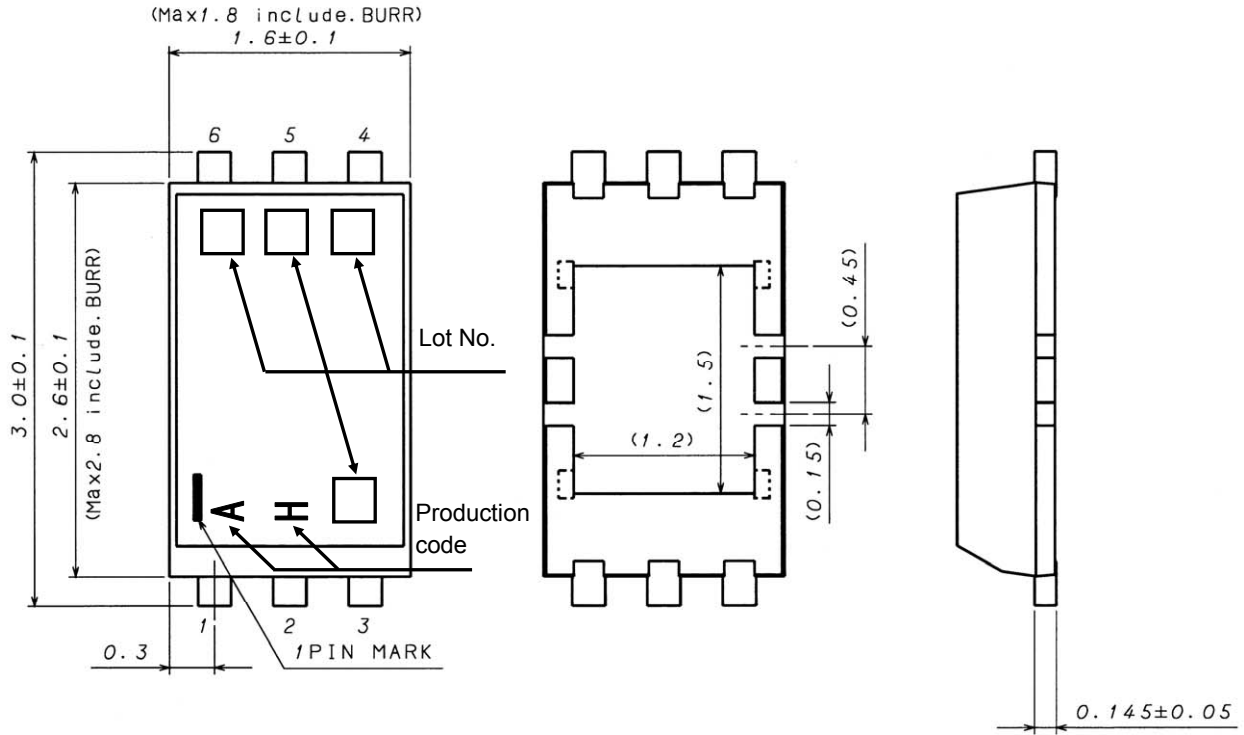

WSOF6 (Unit : mm)

●About an optical design on the device

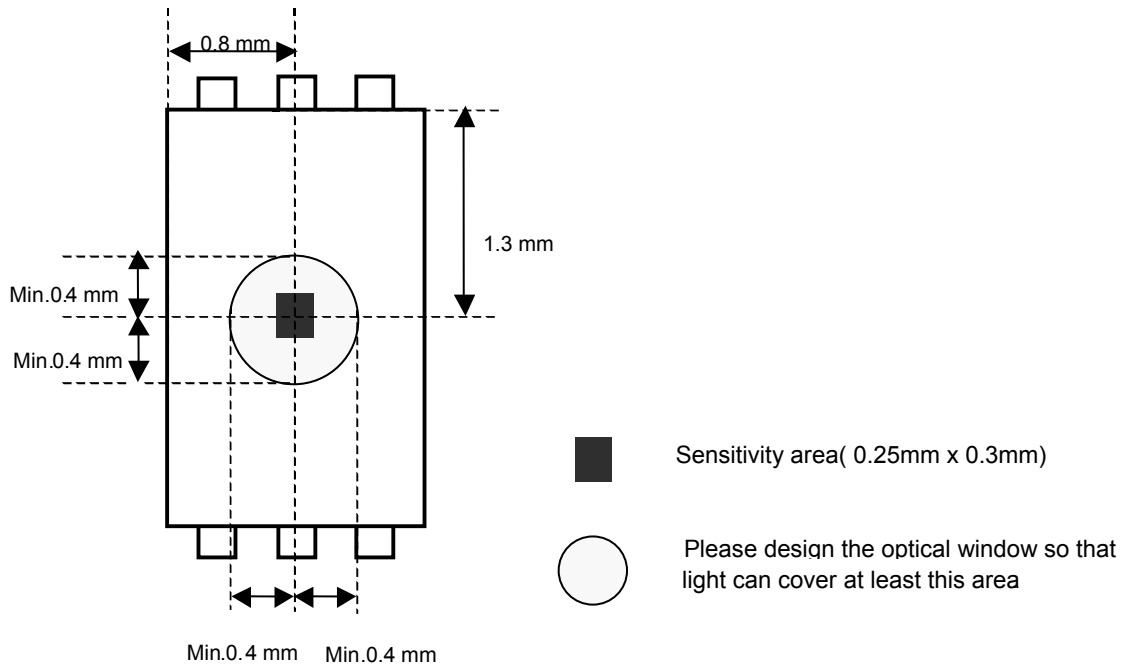

●The method of distinguishing 1pin.

There is some method of distinguishing 1pin.

- ① Distinguishing by 1Pin marking
- ② Distinguishing by die pattern
- ③ Distinguishing by taper part of 1-3pin side

②(by die pattern) is the easiest method to distinguish by naked eye.

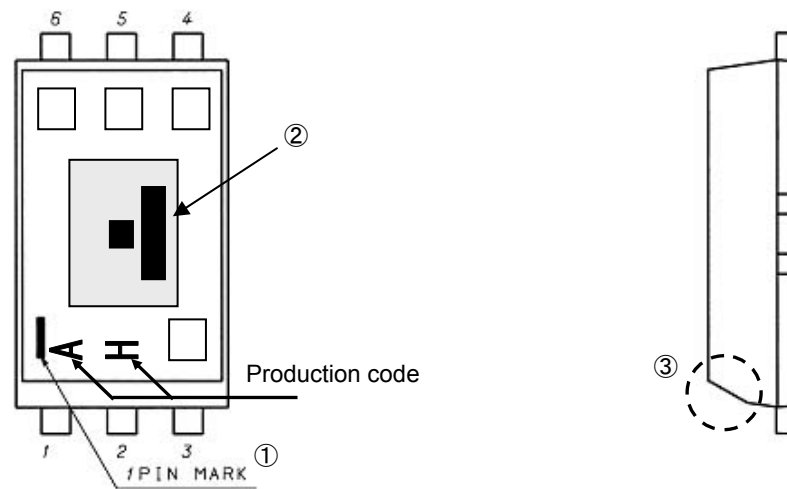

●Notes for use

- 1) Absolute Maximum Ratings
An excess in the absolute maximum ratings, such as supply voltage (V_{ccmax}), temperature range of operating conditions (T_{opr}), etc., can break down devices, thus making impossible to identify breaking mode such as a short circuit or an open circuit. If any special mode exceeding the absolute maximum ratings is assumed, consideration should be given to take physical safety measures including the use of fuses, etc.
- 2) GND voltage
Make setting of the potential of the GND terminal so that it will be maintained at the minimum in any operating state. Furthermore, check to be sure no terminals are at a potential lower than the GND voltage including an actual electric transient.
- 3) Short circuit between terminals and erroneous mounting
In order to mount ICs on a set PCB, pay thorough attention to the direction and offset of the ICs. Erroneous mounting can break down the ICs. Furthermore, if a short circuit occurs due to foreign matters entering between terminals or between the terminal and the power supply or the GND terminal, the ICs can break down.
- 4) Operation in strong electromagnetic field
Be noted that using ICs in the strong electromagnetic field can malfunction them.
- 5) Inspection with set PCB
On the inspection with the set PCB, if a capacitor is connected to a low-impedance IC terminal, the IC can suffer stress. Therefore, be sure to discharge from the set PCB by each process. Furthermore, in order to mount or dismount the set PCB to/from the jig for the inspection process, be sure to turn OFF the power supply and then mount the set PCB to the jig. After the completion of the inspection, be sure to turn OFF the power supply and then dismount it from the jig. In addition, for protection against static electricity, establish a ground for the assembly process and pay thorough attention to the transportation and the storage of the set PCB.
- 6) Input terminals
In terms of the construction of IC, parasitic elements are inevitably formed in relation to potential. The operation of the parasitic element can cause interference with circuit operation, thus resulting in a malfunction and then breakdown of the input terminal. Therefore, pay thorough attention not to handle the input terminals; such as to apply to the input terminals a voltage lower than the GND respectively, so that any parasitic element will operate. Furthermore, do not apply a voltage to the input terminals when no power supply voltage is applied to the IC. In addition, even if the power supply voltage is applied, apply to the input terminals a voltage lower than the power supply voltage or within the guaranteed value of electrical characteristics.
- 7) Thermal design
Perform thermal design in which there are adequate margins by taking into account the power dissipation (P_d) in actual states of use.
- 8) Treatment of package
Dusts or scratch on the photo detector may affect the optical characteristics. Please handle it with care.
- 9) Rush current
When power is first supplied to the CMOS IC, it is possible that the internal logic may be unstable and rush current may flow instantaneously. Therefore, give special consideration to power coupling capacitance, power wiring, width of GND wiring, and routing of connections.
- 10) The exposed central pad on the back side of the package
There is an exposed central pad on the back side of the package. But please do it non connection. (Don't solder, and don't do electrical connection) Please mount by Footprint dimensions described in the Jisso Information for WSO6I. This pad is GND level, therefore there is a possibility that LSI malfunctions and heavy-current is generated.

●Ordering part number

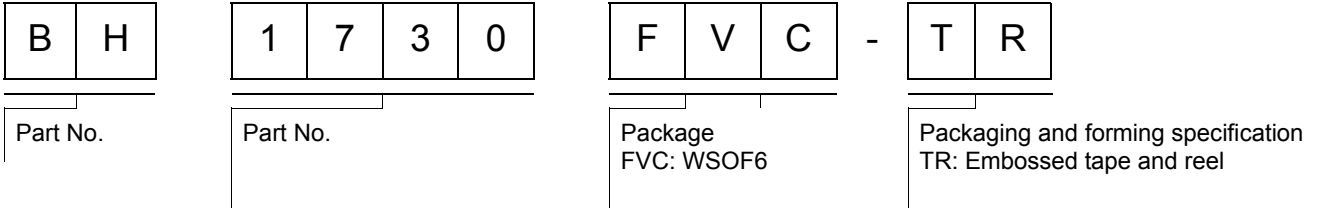

WSOF6

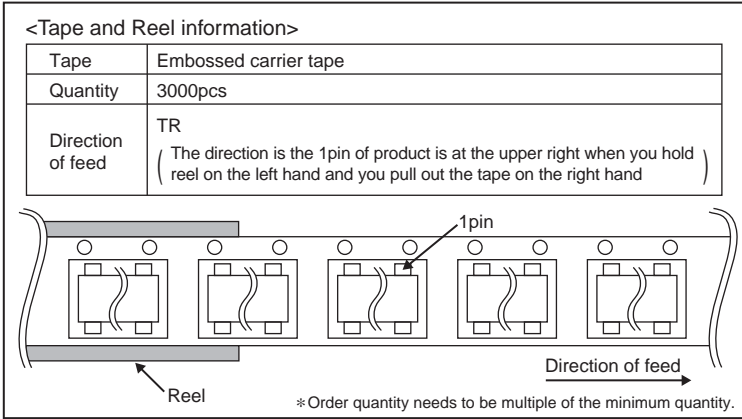
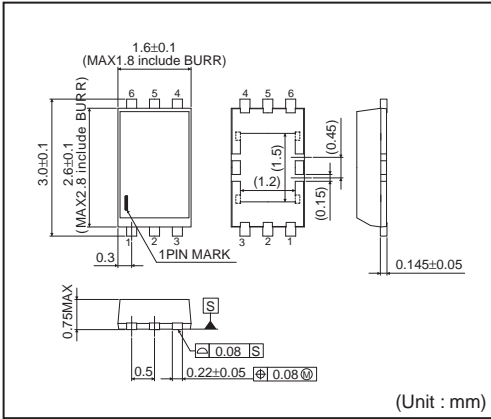

Notes

No copying or reproduction of this document, in part or in whole, is permitted without the consent of ROHM Co.,Ltd.

The content specified herein is subject to change for improvement without notice.

The content specified herein is for the purpose of introducing ROHM's products (hereinafter "Products"). If you wish to use any such Product, please be sure to refer to the specifications, which can be obtained from ROHM upon request.

Examples of application circuits, circuit constants and any other information contained herein illustrate the standard usage and operations of the Products. The peripheral conditions must be taken into account when designing circuits for mass production.

Great care was taken in ensuring the accuracy of the information specified in this document. However, should you incur any damage arising from any inaccuracy or misprint of such information, ROHM shall bear no responsibility for such damage.

The technical information specified herein is intended only to show the typical functions of and examples of application circuits for the Products. ROHM does not grant you, explicitly or implicitly, any license to use or exercise intellectual property or other rights held by ROHM and other parties. ROHM shall bear no responsibility whatsoever for any dispute arising from the use of such technical information.

The Products specified in this document are intended to be used with general-use electronic equipment or devices (such as audio visual equipment, office-automation equipment, communication devices, electronic appliances and amusement devices).

The Products specified in this document are not designed to be radiation tolerant.

While ROHM always makes efforts to enhance the quality and reliability of its Products, a Product may fail or malfunction for a variety of reasons.

Please be sure to implement in your equipment using the Products safety measures to guard against the possibility of physical injury, fire or any other damage caused in the event of the failure of any Product, such as derating, redundancy, fire control and fail-safe designs. ROHM shall bear no responsibility whatsoever for your use of any Product outside of the prescribed scope or not in accordance with the instruction manual.

The Products are not designed or manufactured to be used with any equipment, device or system which requires an extremely high level of reliability the failure or malfunction of which may result in a direct threat to human life or create a risk of human injury (such as a medical instrument, transportation equipment, aerospace machinery, nuclear-reactor controller, fuel-controller or other safety device). ROHM shall bear no responsibility in any way for use of any of the Products for the above special purposes. If a Product is intended to be used for any such special purpose, please contact a ROHM sales representative before purchasing.

If you intend to export or ship overseas any Product or technology specified herein that may be controlled under the Foreign Exchange and the Foreign Trade Law, you will be required to obtain a license or permit under the Law.



Thank you for your accessing to ROHM product informations.
More detail product informations and catalogs are available, please contact us.

ROHM Customer Support System

<http://www.rohm.com/contact/>

