



DUAL MICROPOWER PRECISION RAIL-TO-RAIL CMOS OPERATIONAL AMPLIFIER

GENERAL DESCRIPTION

The ALD2711 is a dual monolithic CMOS micropower precision high slew rate operational amplifier intended for a broad range of analog applications using $\pm 1V$ to $\pm 6V$ dual power supply systems, as well as +2V to +12V battery operated systems. All device characteristics are specified for +5V single supply or $\pm 2.5V$ dual supply systems. Typical supply current is 200 μA at 5V supply voltage. It is manufactured with Advanced Linear Devices' enhanced ACMOS silicon gate CMOS process.

The device has an input stage that operates to +300mV above and -300mV below the supply voltages with no adverse effects and/or phase reversals.

The ALD2711 has been developed specifically for the +5V single supply or $\pm 1V$ to $\pm 6V$ dual supply user. Several important characteristics of the device make application easier to implement at those voltages. First, each operational amplifier can operate with rail to rail input and output voltages. This means the signal input voltage and output voltage can be at the positive and negative supply voltages. This feature allows numerous analog serial stages and flexibility in input signal bias levels. Secondly, each device was designed to accommodate mixed applications where digital and analog circuits may operate off the same power supply or battery. Thirdly, the output stage can typically drive up to 50pF capacitive and 10K Ω resistive loads.

These features, combined with extremely low input currents, high open loop voltage gain, high useful bandwidth, and slew rate make the ALD2711 a versatile, micropower operational amplifier.

The ALD2711 with on-chip offset voltage trimming allows the device to be used without nulling in most applications. The unique characteristics of the ALD2711 are modeled in an available macromodel.

FEATURES

- Designed and characterized for 5V operation
- Linear mode operation with input voltages 300mV beyond supply rails
- Output voltages to within 2mV of power supply rails when driving a high impedance load
- Unity gain stable
- Extremely low input bias currents -- 0.01pA
- Dual power supply $\pm 1.0V$ to $\pm 6.0V$
- Single power supply +2V to +12V
- High voltage gain
- Output short circuit protected
- Unity gain bandwidth of 0.7MHz
- Slew rate of 0.7V/ μs
- Low power dissipation
- Symmetrical complementary output drive

APPLICATIONS

- Voltage follower/buffer/amplifier
- Charge integrator
- Photodiode amplifier
- Data acquisition systems
- High performance portable instruments
- Signal conditioning circuits
- Sensor and transducer amplifiers
- Low leakage amplifiers
- Active filters
- Sample/Hold amplifier
- Picoammeter
- Current to voltage converter

ORDERING INFORMATION

| Operating Temperature Range | | |
|-----------------------------|--|---------------------------------|
| -55°C to +125°C | 0°C to +70°C | 0°C to +70°C |
| 8-Pin CERDIP Package | 8-Pin Small Outline Package (SOIC) | 8-Pin Plastic Dip Package |
| ALD 2711A DA | ALD 2711A SA | ALD 2711A PA |
| ALD 2711B DA | ALD 2711B SA | ALD 2711B PA |
| ALD 2711 DA | ALD 2711 SA | ALD 2711 PA |

* Contact factory for industrial temperature range.

PIN CONFIGURATION

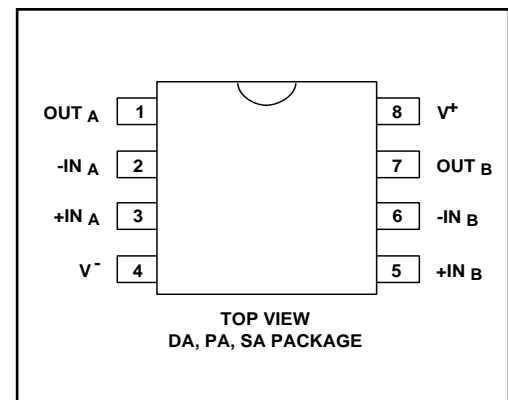

ABSOLUTE MAXIMUM RATINGS

Supply voltage, V+ _____ 13.2V
 Differential input voltage range _____ -0.3V to V+ +0.3V
 Power dissipation _____ 600 mW
 Operating temperature range PA,SA package _____ 0°C to +70°C
 DA package _____ -55°C to +125°C
 Storage temperature range _____ -65°C to +150°C
 Lead temperature, 10 seconds _____ +260°C

OPERATING ELECTRICAL CHARACTERISTICS T_A = 25°C V_S = ±2.5V unless otherwise specified

| Parameter | Symbol | 2711A | | | 2711B | | | 2711 | | | Unit | Test Conditions |
|------------------------------|---------------------|--------------|------------------|-------------|--------------|------------------|-------------|--------------|------------------|-------------|--|--|
| | | Min | Typ | Max | Min | Typ | Max | Min | Typ | Max | | |
| Supply Voltage | V _S | ±1.0 | | ±6.3 | ±1.0 | | ±6.3 | ±1.0 | | ±6.0 | V | Dual Supply Single Supply |
| | V+ | 2.0 | | 12.6 | 2.0 | | 12.6 | 2.0 | | 12.6 | V | |
| Input Offset Voltage | V _{OS} | | 0.25 | 0.6 1.0 | | 0.5 | 1.0 1.5 | | 0.8 | 1.5 2.0 | mV mV | R _S ≤ 100KΩ 0°C ≤ T _A ≤ +70°C |
| Input Offset Current | I _{OS} | | 0.01 | 10 280 | | 0.01 | 10 280 | | 0.01 | 10 280 | pA pA | T _A = 25°C 0°C ≤ T _A ≤ +70°C |
| Input Bias Current | I _B | | 0.01 | 10 280 | | 0.01 | 10 280 | | 0.01 | 10 280 | pA pA | T _A = 25°C 0°C ≤ T _A ≤ +70°C |
| Input Voltage Range | V _{IR} | -0.3 -2.8 | | 5.3 2.8 | -0.3 -2.8 | | 5.3 2.8 | -0.3 -2.8 | | 5.3 2.8 | V V | V ⁺ = +5V V _S = ±2.5V |
| Input Resistance | R _{IN} | | 10 ¹³ | | | 10 ¹³ | | | 10 ¹³ | | Ω | |
| Input Offset Voltage Drift | TCV _{OS} | | 5 | | | 5 | | | 7 | | μV/°C | R _S ≤ 100KΩ |
| Power Supply Rejection Ratio | PSRR | 63 | 90 | | 63 | 90 | | 60 | 90 | | dB dB | R _S ≤ 100KΩ 0°C ≤ T _A ≤ +70°C |
| | | 63 | 90 | | 63 | 90 | | 60 | 90 | | | |
| Common Mode Rejection Ratio | CMRR | 63 | 90 | | 63 | 90 | | 60 | 90 | | dB dB | R _S ≤ 100KΩ 0°C ≤ T _A ≤ +70°C |
| | | 63 | 90 | | 63 | 90 | | 60 | 90 | | | |
| Large Signal Voltage Gain | A _V | 15 | 100 | | 15 | 100 | | 10 | 100 | | V/mV V/mV V/mV | R _L = 100KΩ R _L ≥ 1MΩ R _L = 100KΩ 0°C ≤ T _A ≤ +70°C |
| | | | 300 | | | 300 | | | | | | |
| | | 10 | | | 10 | | | 7 | | | | |
| Output Voltage Range | V _O low | | 0.001 | 0.01 | | 0.001 | 0.01 | | 0.001 | 0.01 | V V V | R _L = 1MΩ V ⁺ = +5V 0°C ≤ T _A ≤ +70°C |
| | V _O high | 4.99 | 4.999 | | 4.99 | 4.999 | | 4.99 | 4.999 | | | |
| | V _O low | | -2.48 | -2.40 | | -2.48 | -2.40 | | -2.48 | -2.40 | | |
| | V _O high | 2.40 | 2.48 | | 2.40 | 2.48 | | 2.40 | 2.48 | | R _L = 100KΩ 0°C ≤ T _A ≤ +70°C | |
| Output Short Circuit Current | I _{SC} | | 1 | | | 1 | | | 1 | | mA | |
| Supply Current | I _S | | 200 | 450 | | 200 | 450 | | 200 | 450 | μA | V _{IN} = 0V No Load |
| Power Dissipation | P _D | | 1.0 0.25 | 2.25 0.6 | | 1.0 0.25 | 2.25 0.6 | | 1.0 0.25 | 2.25 0.6 | mW | V _S = ±2.5V Both V _S = ±1.0V amplifiers |

OPERATING ELECTRICAL CHARACTERISTICS (cont'd)

$T_A = 25^\circ\text{C}$ $V_S = \pm 2.5\text{V}$ unless otherwise specified

| Parameter | Symbol | 2711A | | | 2711B | | | 2711 | | | Unit | Test Conditions |
|--------------------|----------|-------|------|-----|-------|------|-----|------|------|-----|------------------|--|
| | | Min | Typ | Max | Min | Typ | Max | Min | Typ | Max | | |
| Input Capacitance | C_{IN} | | 1 | | | 1 | | | 1 | | pF | |
| Bandwidth | B_W | | 700 | | | 700 | | | 700 | | KHz | |
| Slew Rate | S_R | | 0.7 | | | 0.7 | | | 0.7 | | V/ μs | $A_V = +1$ $R_L = 100\text{K}\Omega$ |
| Rise time | t_r | | 0.2 | | | 0.2 | | | 0.2 | | μs | $R_L = 100\text{K}\Omega$ |
| Overshoot Factor | | | 20 | | | 20 | | | 20 | | % | $R_L = 100\text{K}\Omega$ $C_L = 50\text{pF}$ |
| Settling Time | t_s | | 10.0 | | | 10.0 | | | 10.0 | | μs | 0.1% $A_V = 100$ $R_L = 100\text{K}\Omega$ $C_L = 50\text{pF}$ |
| Channel Separation | C_S | | 140 | | | 140 | | | 140 | | dB | $A_V = 100$ |

$T_A = 25^\circ\text{C}$ $V_S = \pm 5.0\text{V}$ unless otherwise specified

| Parameter | Symbol | 2711A | | | 2711B | | | 2711 | | | Unit | Test Conditions |
|------------------------------|---|-------|---------------|-------|-------|---------------|-------|------|---------------|-------|------------------|-----------------------------------|
| | | Min | Typ | Max | Min | Typ | Max | Min | Typ | Max | | |
| Power Supply Rejection Ratio | PSRR | | 100 | | | 100 | | | 100 | | dB | $R_S \leq 100\text{K}\Omega$ |
| Common Mode Rejection Ratio | CMRR | | 100 | | | 100 | | | 100 | | dB | $R_S \leq 100\text{K}\Omega$ |
| Large Signal Voltage Gain | A_V | | 300 | | | 300 | | | 300 | | V/mV | $R_L = 100\text{K}\Omega$ |
| Output Voltage Range | $V_{O\text{ low}}$ $V_{O\text{ high}}$ | 4.90 | -4.98 4.98 | -4.90 | 4.90 | -4.98 4.98 | -4.90 | 4.90 | -4.98 4.98 | -4.90 | V V | $R_L = 100\text{K}\Omega$ |
| Bandwidth | B_W | | 1.0 | | | 1.0 | | | 1.0 | | MHz | |
| Slew Rate | S_R | | 1.0 | | | 1.0 | | | 1.0 | | V/ μs | $A_V = +1$ $C_L = 50\text{pF}$ |

$V_S = \pm 2.5\text{V}$ $-55^\circ\text{C} \leq T_A \leq +125^\circ\text{C}$ unless otherwise specified

| Parameter | Symbol | 2711A DA | | | 2711B DA | | | 2711 DA | | | Unit | Test Conditions |
|------------------------------|---|----------|---------------|-------|----------|---------------|-------|---------|---------------|-------|--------|------------------------------|
| | | Min | Typ | Max | Min | Typ | Max | Min | Typ | Max | | |
| Input Offset Voltage | V_{OS} | | | 1.5 | | | 2.0 | | | 2.5 | mV | $R_S \leq 100\text{K}\Omega$ |
| Input Offset Current | I_{OS} | | | 4 | | | 4 | | | 4 | nA | |
| Input Bias Current | I_B | | | 4 | | | 4 | | | 4 | nA | |
| Power Supply Rejection Ratio | PSRR | 60 | 85 | | 60 | 85 | | 60 | 85 | | dB | $R_S \leq 100\text{K}\Omega$ |
| Common Mode Rejection Ratio | CMRR | 60 | 83 | | 60 | 83 | | 60 | 83 | | dB | $R_S \leq 100\text{K}\Omega$ |
| Large Signal Voltage Gain | A_V | 10 | 50 | | 10 | 50 | | 10 | 50 | | V/mV | $R_L \leq 100\text{K}\Omega$ |
| Output Voltage Range | $V_{O\text{ low}}$ $V_{O\text{ high}}$ | 2.35 | -2.47 2.45 | -2.40 | 2.35 | -2.47 2.45 | -2.40 | 2.35 | -2.47 2.45 | -2.40 | V V | $R_L \leq 100\text{K}\Omega$ |

Design & Operating Notes:

1. The ALD2711 CMOS operational amplifier uses a 3 gain stage architecture and an improved frequency compensation scheme to achieve large voltage gain, high output driving capability, and better frequency stability. In a conventional CMOS operational amplifier design, compensation is achieved with a pole splitting capacitor together with a nulling resistor. This method is, however, very bias dependent and thus cannot accommodate the large range of supply voltage operation as is required from a stand alone CMOS operational amplifier. The ALD2711 is internally compensated for unity gain stability using a novel scheme that does not use a nulling resistor. This scheme produces a clean single pole roll off in the gain characteristics while providing for more than 70 degrees of phase margin at the unity gain frequency.
2. The ALD2711 has complementary p-channel and n-channel input differential stages connected in parallel to accomplish rail to rail input common mode voltage range. This means that with the ranges of common mode input voltage close to the power supplies, one of the two differential stages is switched off internally. To maintain compatibility with other operational amplifiers, this switching point has been selected to be about 1.5V below the positive supply voltage. Since offset voltage trimming on the ALD2711 is made when the input voltage is symmetrical to the supply voltages, this internal switching does not affect a large variety of applications such as an inverting amplifier or non-inverting amplifier with a gain larger than 2.5 (5V operation), where the common mode voltage does not make excursions above this switching point. The user should however, be aware that this switching does take place if the operational amplifier is connected as a unity gain buffer and should make provision in his design to allow for input offset voltage variations.
3. The input bias and offset currents are essentially input protection diode

reverse bias leakage currents, and are typically less than 1pA at room temperature. This low input bias current assures that the analog signal from the source will not be distorted by input bias currents. Normally, this extremely high input impedance of greater than $10^{12}\Omega$ would not be a problem as the source impedance would limit the node impedance. However, for applications where source impedance is very high, it may be necessary to limit noise and hum pickup through proper shielding.

4. The output stage consists of class AB complementary output drivers, capable of driving a low resistance load. The output voltage swing is limited by the drain to source on-resistance of the output transistors as determined by the bias circuitry, and the value of the load resistor. When connected in the voltage follower configuration, the oscillation resistant feature, combined with the rail to rail input and output feature, makes an effective analog signal buffer for medium to high source impedance sensors, transducers, and other circuit networks.
5. The ALD2711 operational amplifier has been designed to provide full static discharge protection. Internally, the design has been carefully implemented to minimize latch up. However, care must be exercised when handling the device to avoid strong static fields that may degrade a diode junction, causing increased input leakage currents. In using the operational amplifier, the user is advised to power up the circuit before, or simultaneously with, any input voltages applied and to limit input voltages to not exceed 0.3V of the power supply voltage levels.
6. The ALD2711, with its micropower operation, offers numerous benefits in reduced power supply requirements, less noise coupling and current spikes, less thermally induced drift, better overall reliability due to lower self heating, and lower input bias current. It requires practically no warm up time as the chip junction heats up to only 0.2°C above ambient temperature under most operating conditions.

TYPICAL PERFORMANCE CHARACTERISTICS

SUPPLY CURRENT AS A FUNCTION OF SUPPLY VOLTAGE

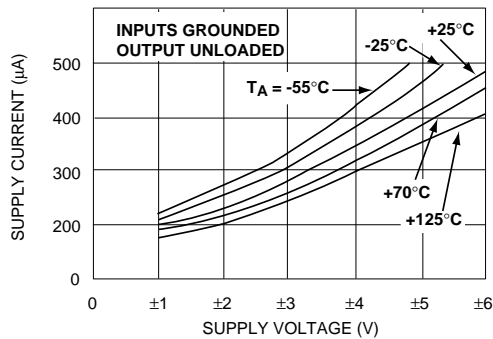

COMMON MODE INPUT VOLTAGE RANGE AS A FUNCTION OF SUPPLY VOLTAGE

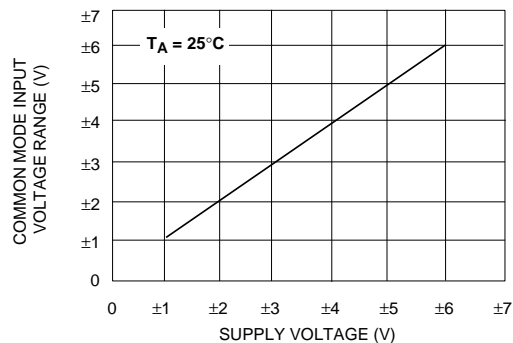

OPEN LOOP VOLTAGE GAIN AS A FUNCTION OF LOAD RESISTANCE

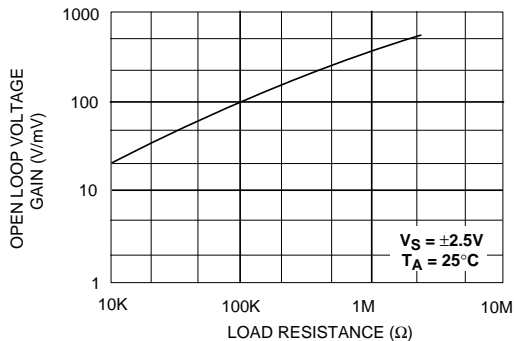

INPUT BIAS CURRENT AS A FUNCTION OF AMBIENT TEMPERATURE

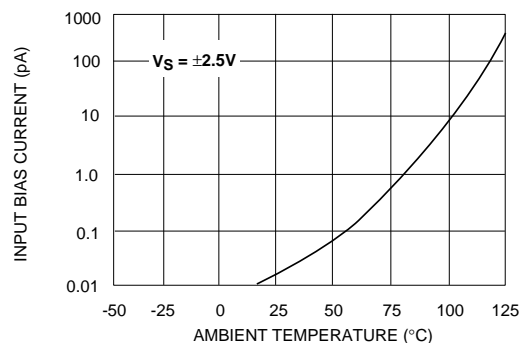

TYPICAL PERFORMANCE CHARACTERISTICS

OPEN LOOP VOLTAGE GAIN AS A FUNCTION OF SUPPLY VOLTAGE AND TEMPERATURE

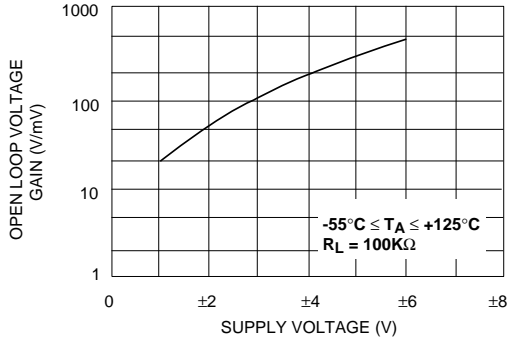

OUTPUT VOLTAGE SWING AS A FUNCTION OF SUPPLY VOLTAGE

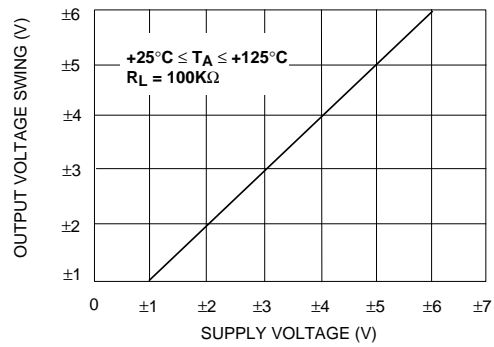

INPUT OFFSET VOLTAGE AS A FUNCTION OF AMBIENT TEMPERATURE REPRESENTATIVE UNITS

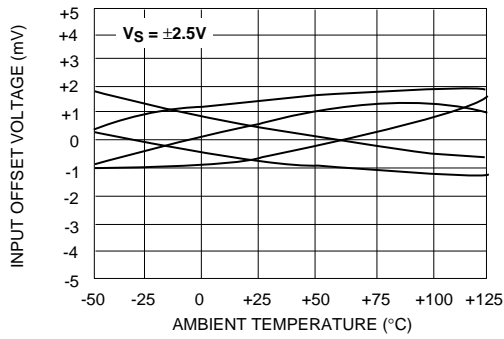

OPEN LOOP VOLTAGE AS A FUNCTION OF FREQUENCY

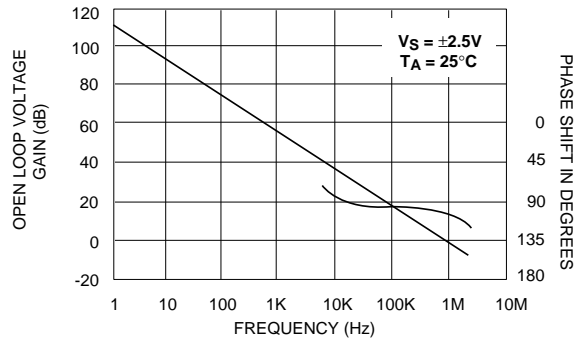

INPUT OFFSET VOLTAGE AS A FUNCTION OF COMMON MODE INPUT VOLTAGE

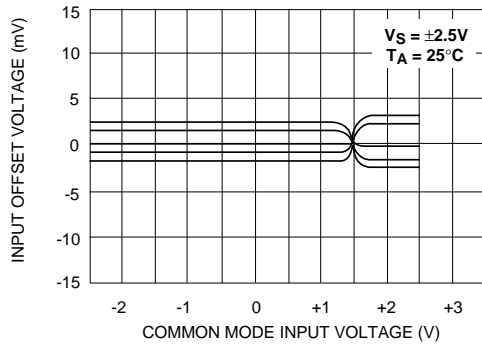

LARGE - SIGNAL TRANSIENT RESPONSE

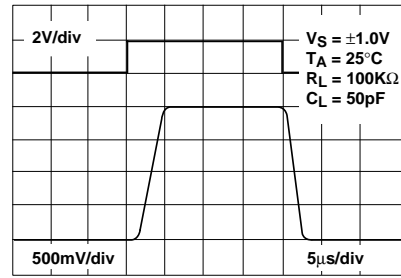

LARGE - SIGNAL TRANSIENT RESPONSE

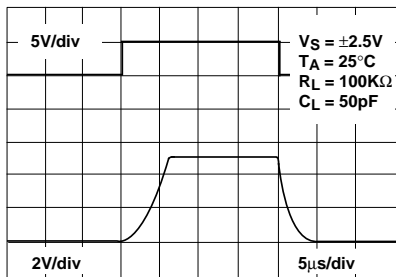

SMALL - SIGNAL TRANSIENT RESPONSE

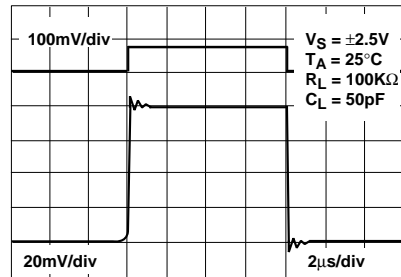

TYPICAL APPLICATIONS

RAIL-TO-RAIL VOLTAGE FOLLOWER/BUFFER

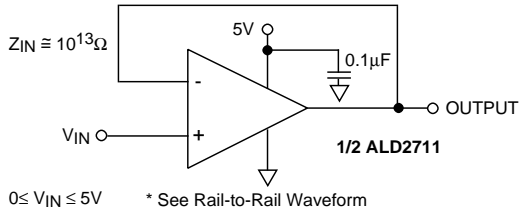

RAIL-TO-RAIL WAVEFORM

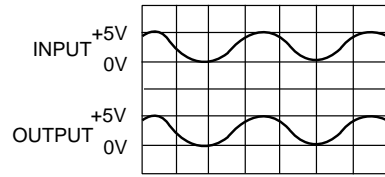

Performance waveforms.
Upper trace is the output of a Wien Bridge Oscillator. Lower trace is the output of Rail-to-Rail voltage follower.

HIGH INPUT IMPEDANCE RAIL-TO-RAIL PRECISION DC SUMMING AMPLIFIER

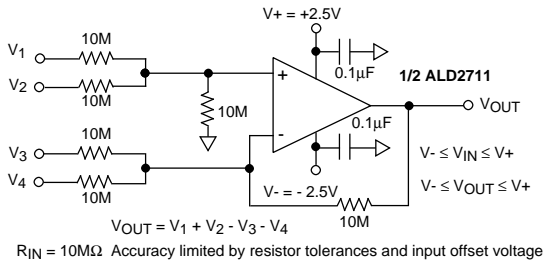

RAIL-TO-RAIL WINDOW COMPARATOR

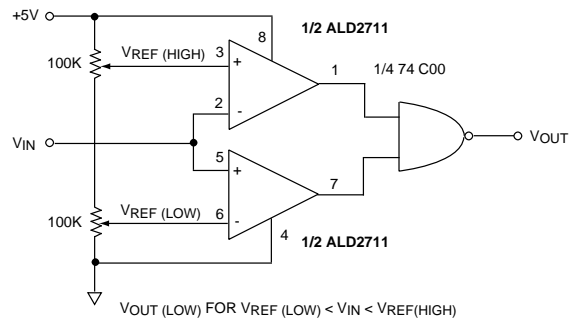

WIEN BRIDGE OSCILLATOR (RAIL-TO-RAIL) SINE WAVE GENERATOR

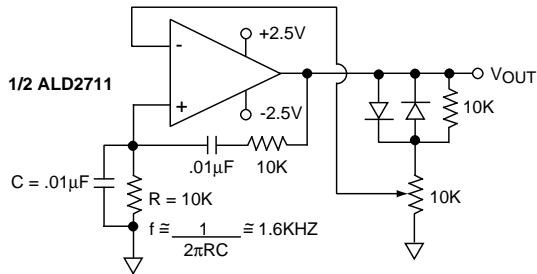

* See Rail-to-Rail Waveform

PHOTO DETECTOR CURRENT TO VOLTAGE CONVERTER

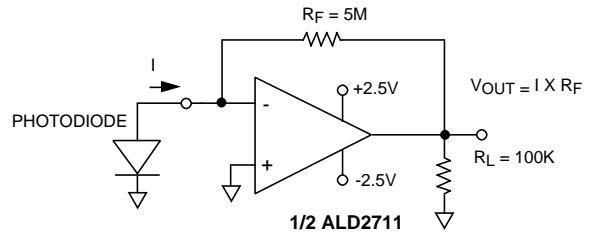

LOW VOLTAGE INSTRUMENTATION AMPLIFIER

