

PRELIMINARY

# IRL1104S/L

HEXFET® Power MOSFET

- Logic-Level Gate Drive
- Advanced Process Technology
- Surface Mount (IRL1104S)
- Low-profile through-hole (IRL1104L)
- 175°C Operating Temperature
- Fast Switching
- Fully Avalanche Rated

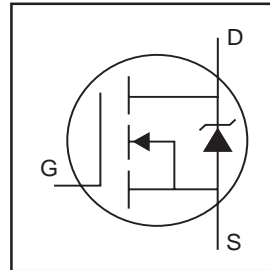

|                            |
|----------------------------|
| $V_{DSS} = 40V$            |
| $R_{DS(on)} = 0.008\Omega$ |
| $I_D = 104A\text{⑥}$       |

## Description

Fifth Generation HEXFETs from International Rectifier utilize advanced processing techniques to achieve extremely low on-resistance per silicon area. This benefit, combined with the fast switching speed and ruggedized device design that HEXFET Power MOSFETs are well known for, provides the designer with an extremely efficient and reliable device for use in a wide variety of applications.

The D<sup>2</sup>Pak is a surface mount power package capable of accommodating die sizes up to HEX-4. It provides the highest power capability and the lowest possible on-resistance in any existing surface mount package. The D<sup>2</sup>Pak is suitable for high current applications because of its low internal connection resistance and can dissipate up to 2.0W in a typical surface mount application.

The through-hole version (IRL1104L) is available for low-profile applications.

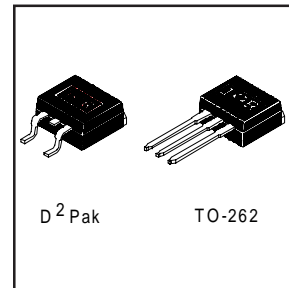

## Absolute Maximum Ratings

|                           | Parameter  | Max.                   | Units |
|---------------------------|--|------------------------|-------|
| $I_D @ T_C = 25^\circ C$  | Continuous Drain Current, $V_{GS} @ 10V\text{⑤}$ | 104⑥                   | A     |
| $I_D @ T_C = 100^\circ C$ | Continuous Drain Current, $V_{GS} @ 10V\text{⑤}$ | 74⑥                    |       |
| $I_{DM}$                  | Pulsed Drain Current ①⑤                          | 416                    |       |
| $P_D @ T_A = 25^\circ C$  | Power Dissipation                                | 2.4                    | W     |
| $P_D @ T_C = 25^\circ C$  | Power Dissipation                                | 167                    | W     |
|                           | Linear Derating Factor                           | 1.1                    | W/°C  |
| $V_{GS}$                  | Gate-to-Source Voltage                           | $\pm 16$               | V     |
| $E_{AS}$                  | Single Pulse Avalanche Energy②⑤                  | 340                    | mJ    |
| $I_{AR}$                  | Avalanche Current①                               | 62                     | A     |
| $E_{AR}$                  | Repetitive Avalanche Energy①                     | 17                     | mJ    |
| dv/dt                     | Peak Diode Recovery dv/dt ③⑤                     | 5.0                    | V/ns  |
| $T_J$                     | Operating Junction and                           | -55 to + 175           | °C    |
| $T_{STG}$                 | Storage Temperature Range                        |                        |       |
|                           | Soldering Temperature, for 10 seconds            | 300 (1.6mm from case ) |       |

## Thermal Resistance

|                 | Parameter  | Typ. | Max. | Units |
|-----------------|--|------|------|-------|
| $R_{\theta JC}$ | Junction-to-Case                                 | —    | 0.9  | °C/W  |
| $R_{\theta JA}$ | Junction-to-Ambient(PCB Mounted, steady-state)** | —    | 62   |       |

**Electrical Characteristics @ T<sub>J</sub> = 25°C (unless otherwise specified)**

|                                      | Parameter                            | Min. | Typ. | Max.  | Units | Conditions  |
|--------------------------------------|--------------------------------------|------|------|-------|-------|---|
| V <sub>(BR)DSS</sub>                 | Drain-to-Source Breakdown Voltage    | 40   | —    | —     | V     | V <sub>GS</sub> = 0V, I <sub>D</sub> = 250μA                        |
| ΔV <sub>(BR)DSS/ΔT<sub>J</sub></sub> | Breakdown Voltage Temp. Coefficient  | —    | 0.04 | —     | V/°C  | Reference to 25°C, I <sub>D</sub> = 1mA <sup>⑤</sup>                |
| R <sub>DS(on)</sub>                  | Static Drain-to-Source On-Resistance | —    | —    | 0.008 | W     | V <sub>GS</sub> = 10V, I <sub>D</sub> = 62A <sup>④</sup>            |
|                                      |                                      | —    | —    | 0.012 |       | V <sub>GS</sub> = 4.5V, I <sub>D</sub> = 52A <sup>④</sup>           |
| V <sub>GS(th)</sub>                  | Gate Threshold Voltage               | 1.0  | —    | —     | V     | V <sub>DS</sub> = V <sub>GS</sub> , I <sub>D</sub> = 250μA          |
| g <sub>fs</sub>                      | Forward Transconductance             | 53   | —    | —     | S     | V <sub>DS</sub> = 25V, I <sub>D</sub> = 62A <sup>⑤</sup>            |
| I <sub>DSS</sub>                     | Drain-to-Source Leakage Current      | —    | —    | 25    | μA    | V <sub>DS</sub> = 40V, V <sub>GS</sub> = 0V                         |
|                                      |                                      | —    | —    | 250   |       | V <sub>DS</sub> = 32V, V <sub>GS</sub> = 0V, T <sub>J</sub> = 150°C |
| I <sub>GSS</sub>                     | Gate-to-Source Forward Leakage       | —    | —    | 100   | nA    | V <sub>GS</sub> = 16V   |
|                                      | Gate-to-Source Reverse Leakage       | —    | —    | -100  |       | V <sub>GS</sub> = -16V  |
| Q <sub>g</sub>                       | Total Gate Charge                    | —    | —    | 68    | nC    | I <sub>D</sub> = 62A  |
| Q <sub>gs</sub>                      | Gate-to-Source Charge                | —    | —    | 24    |       | V <sub>DS</sub> = 32V   |
| Q <sub>gd</sub>                      | Gate-to-Drain ("Miller") Charge      | —    | —    | 34    |       | V <sub>GS</sub> = 4.5V, See Fig. 6 and 13 <sup>④⑤</sup>             |
| t <sub>d(on)</sub>                   | Turn-On Delay Time                   | —    | 18   | —     |       | V <sub>DD</sub> = 20V   |
| t <sub>r</sub>                       | Rise Time                            | —    | 257  | —     |       | I <sub>D</sub> = 54A  |
| t <sub>d(off)</sub>                  | Turn-Off Delay Time                  | —    | 32   | —     |       | R <sub>G</sub> = 3.6Ω, V <sub>GS</sub> = 4.5V                       |
| t <sub>f</sub>                       | Fall Time                            | —    | 64   | —     |       | R <sub>D</sub> = 0.4Ω, See Fig. 10 <sup>④⑤</sup>                    |
| L <sub>S</sub>                       | Internal Source Inductance           | —    | 7.5  | —     | nH    | Between lead, and center of die contact                             |
| C <sub>iss</sub>                     | Input Capacitance                    | —    | 3445 | —     | pF    | V <sub>GS</sub> = 0V  |
| C <sub>oss</sub>                     | Output Capacitance                   | —    | 1065 | —     |       | V <sub>DS</sub> = 25V   |
| C <sub>rss</sub>                     | Reverse Transfer Capacitance         | —    | 270  | —     |       | f = 1.0MHz, See Fig. 5 <sup>⑤</sup>                                 |

**Source-Drain Ratings and Characteristics**

|                 | Parameter                                       | Min.   | Typ. | Max.             | Units | Conditions   |
|-----------------|---|--|------|------------------|-------|--|
| I <sub>S</sub>  | Continuous Source Current (Body Diode)          | —  | —    | 104 <sup>⑥</sup> | A     | MOSFET symbol showing the integral reverse p-n junction diode.                 |
| I <sub>SM</sub> | Pulsed Source Current (Body Diode) <sup>①</sup> | —  | —    | 416              |       |  |
| V <sub>SD</sub> | Diode Forward Voltage                           | —  | —    | 1.3              | V     | T <sub>J</sub> = 25°C, I <sub>S</sub> = 62A, V <sub>GS</sub> = 0V <sup>④</sup> |
| t <sub>rr</sub> | Reverse Recovery Time                           | —  | 84   | 126              | ns    | T <sub>J</sub> = 25°C, I <sub>F</sub> = 62A                                    |
| Q <sub>rr</sub> | Reverse Recovery Charge                         | —  | 223  | 335              | nC    | di/dt = 100A/μs <sup>④⑤</sup>  |
| t <sub>on</sub> | Forward Turn-On Time                            | Intrinsic turn-on time is negligible (turn-on is dominated by L <sub>S</sub> +L <sub>D</sub> ) |      |                  |       |  |

**Notes:**

① Repetitive rating; pulse width limited by max. junction temperature. ( See fig. 11 )

② V<sub>DD</sub> = 15V, starting T<sub>J</sub> = 25°C, L = 0.18mH  
R<sub>G</sub> = 25Ω, I<sub>AS</sub> = 62A. (See Figure 12)

③ I<sub>SD</sub> ≤ 62A, di/dt ≤ 217A/μs, V<sub>DD</sub> ≤ V<sub>(BR)DSS</sub>,  
T<sub>J</sub> ≤ 175°C

④ Pulse width ≤ 300μs; duty cycle ≤ 2%.

⑤ Uses IRL1104 data and test conditions.

⑥ Calculated continuous current based on maximum allowable junction temperature; for recommended current-handling of the package refer to Design Tip # 93-4

\*\* When mounted on 1" square PCB ( FR-4 or G-10 Material ).  
For recommended footprint and soldering techniques refer to application note #AN-994.

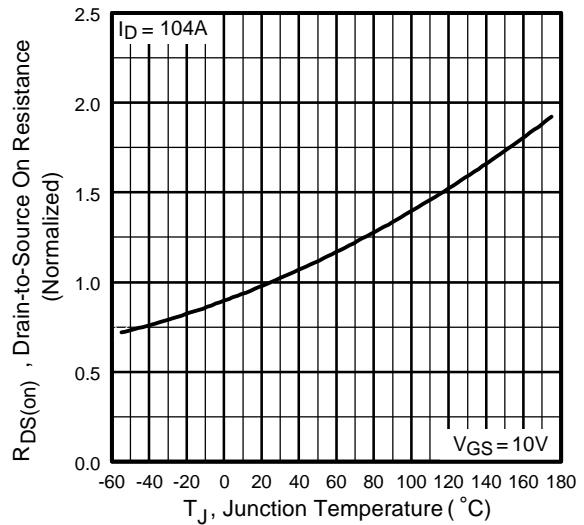
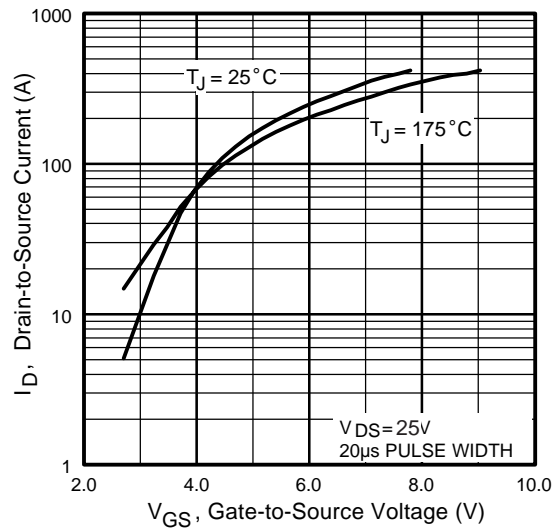
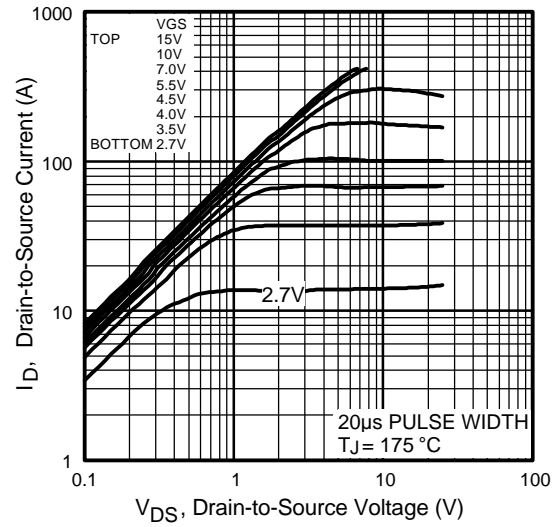
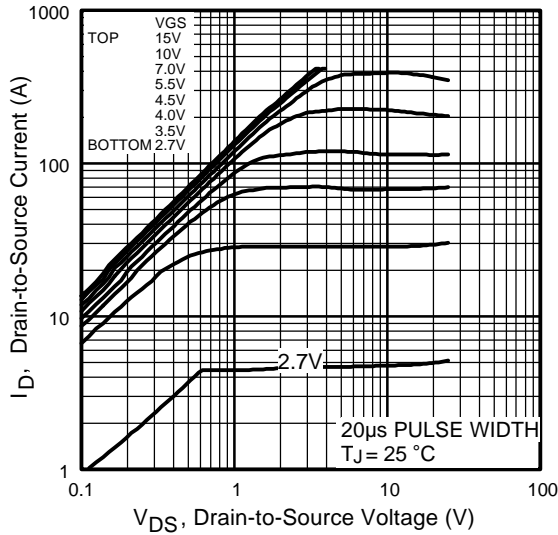

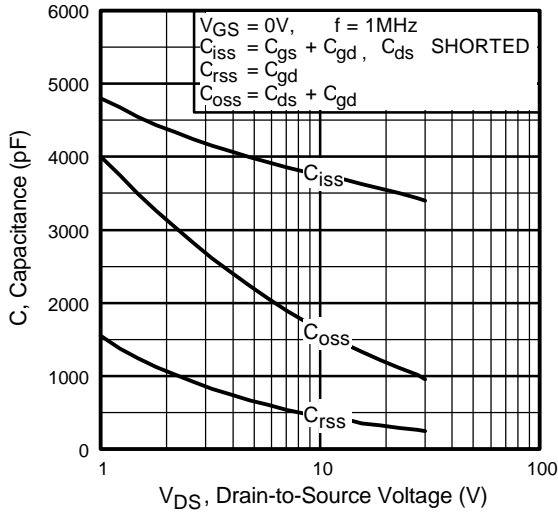

Fig 5. Typical Capacitance Vs. Drain-to-Source Voltage

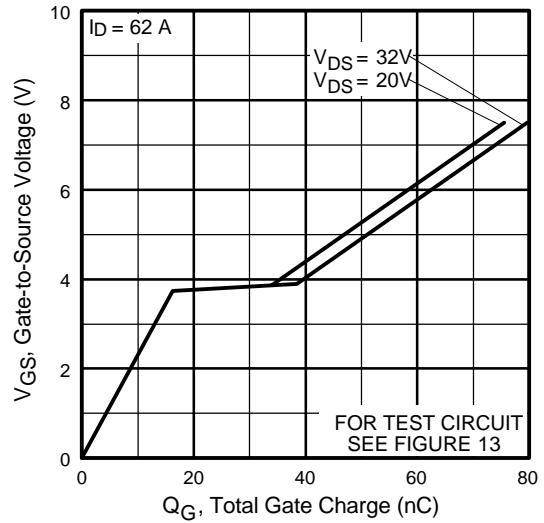

Fig 6. Typical Gate Charge Vs. Gate-to-Source Voltage

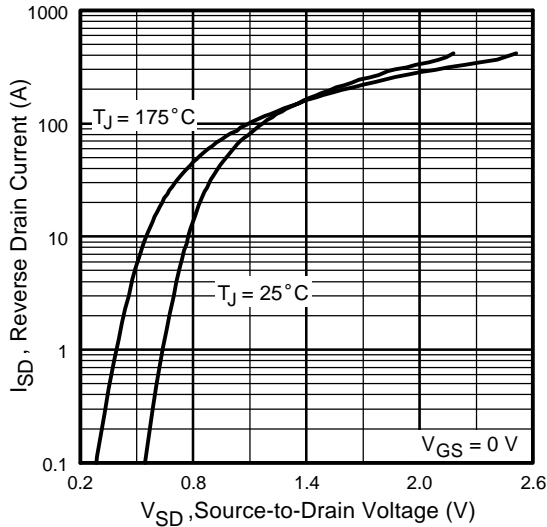

Fig 7. Typical Source-Drain Diode Forward Voltage

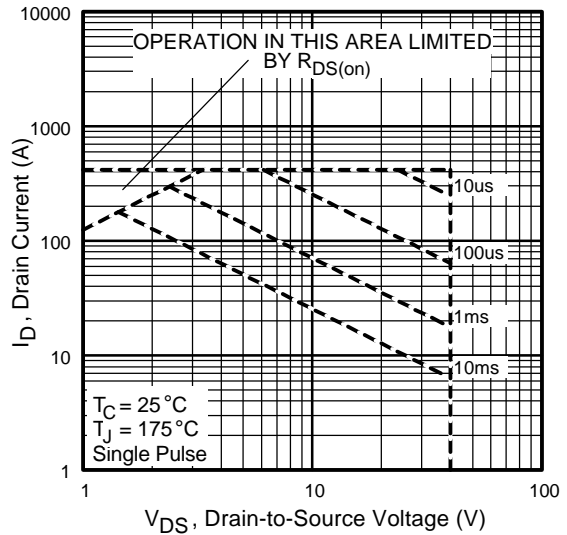

Fig 8. Maximum Safe Operating Area

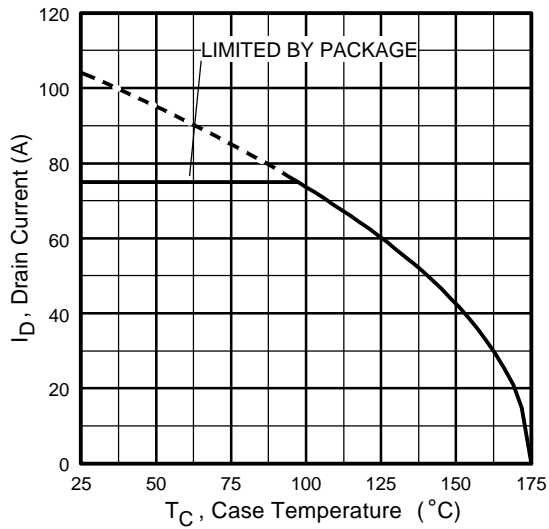

Fig 9. Maximum Drain Current Vs. Case Temperature

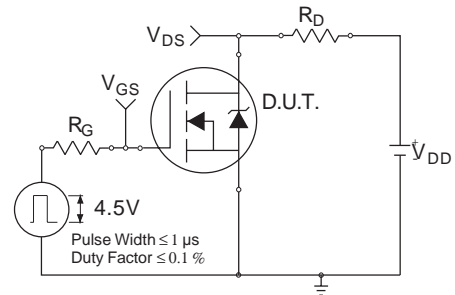

Fig 10a. Switching Time Test Circuit

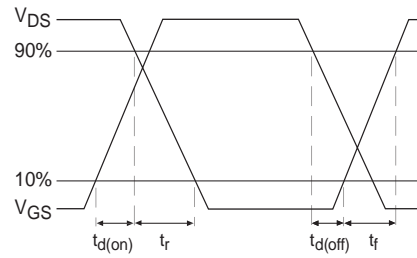

Fig 10b. Switching Time Waveforms

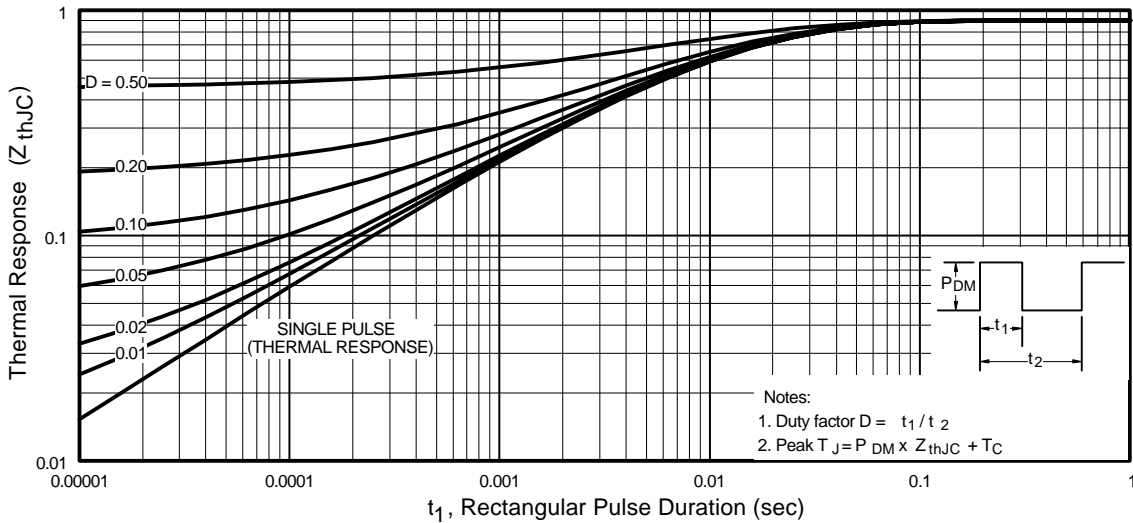

Fig 11. Maximum Effective Transient Thermal Impedance, Junction-to-Case

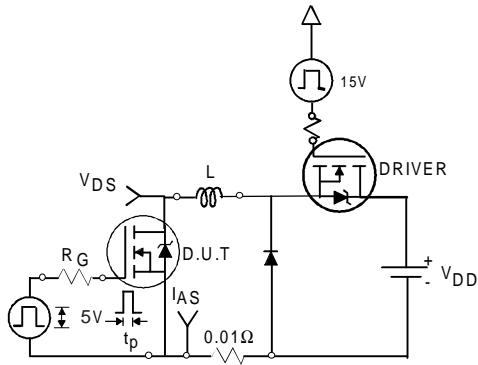

Fig 12a. Unclamped Inductive Test Circuit

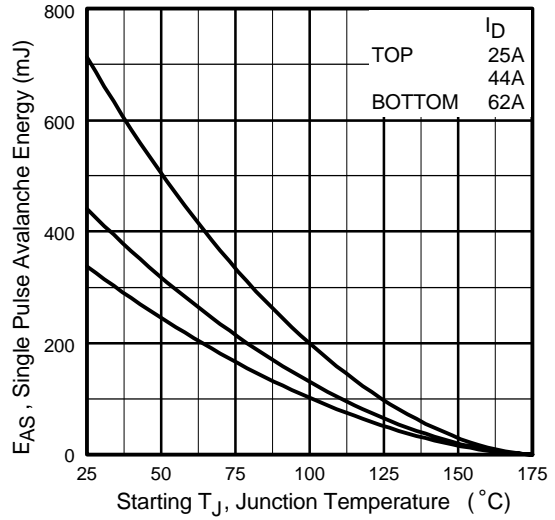

Fig 12c. Maximum Avalanche Energy Vs. Drain Current

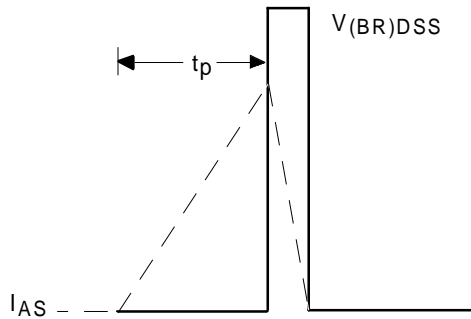

Fig 12b. Unclamped Inductive Waveforms

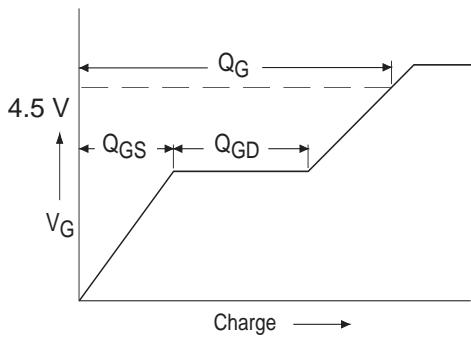

Fig 13a. Basic Gate Charge Waveform

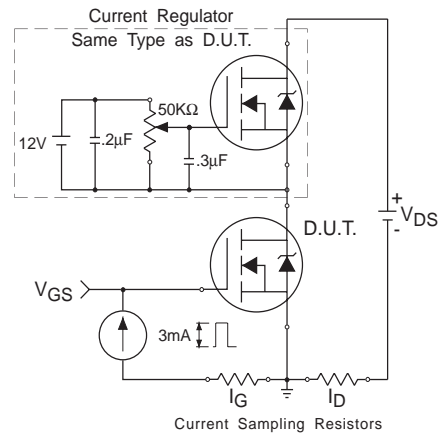
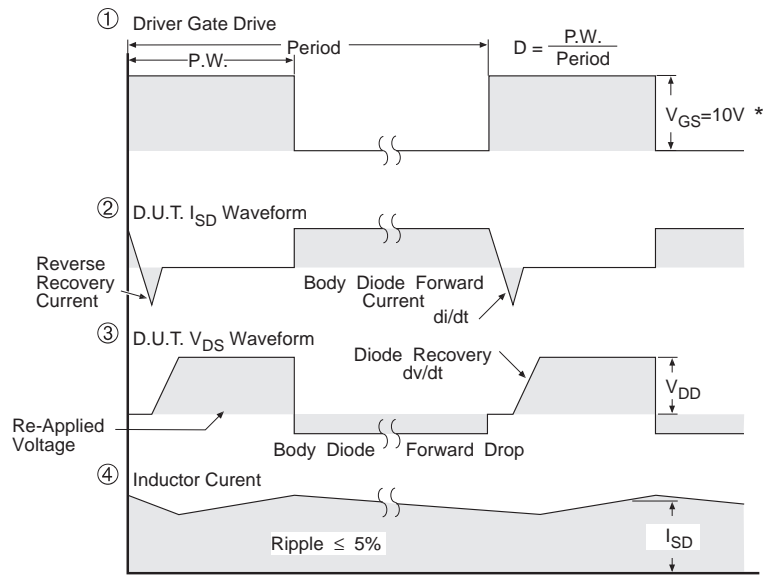
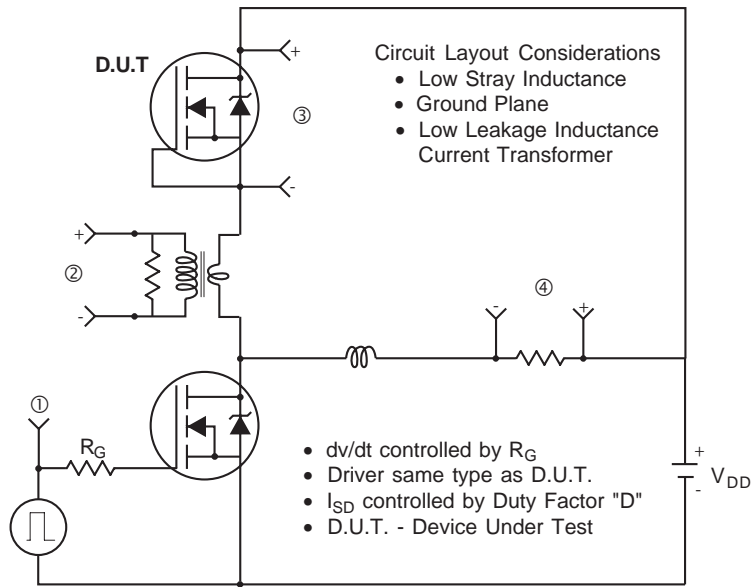

Fig 13b. Gate Charge Test Circuit

Peak Diode Recovery dv/dt Test Circuit



\*  $V_{GS} = 5V$  for Logic Level Devices

Fig 14. For N-Channel HEXFETS

# IRL1104S/L

## D<sup>2</sup>Pak Package Details

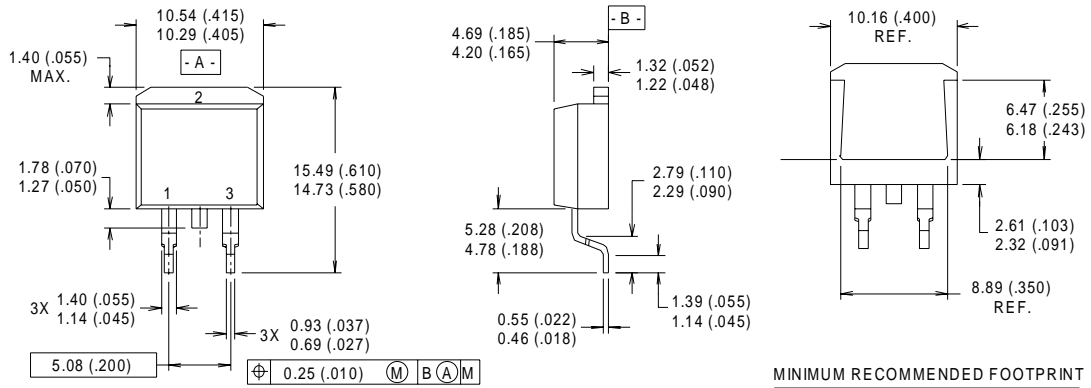

**NOTES:**

- 1 DIMENSIONS AFTER SOLDER DIP.
- 2 DIMENSIONING & TOLERANCING PER ANSI Y14.5M, 1982.
- 3 CONTROLLING DIMENSION : INCH.
- 4 HEATSINK & LEAD DIMENSIONS DO NOT INCLUDE BURRS.

**LEAD ASSIGNMENTS**

- 1 - GATE
- 2 - DRAIN
- 3 - SOURCE

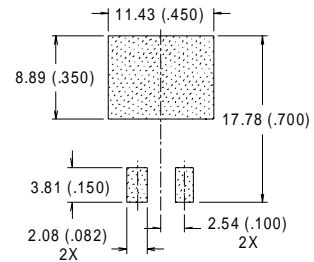

## Part Marking

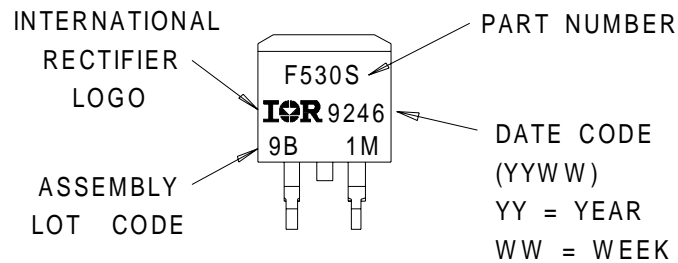



**TO-262 Package Details**

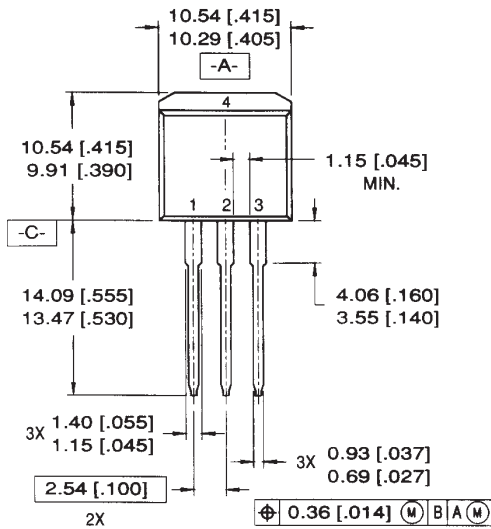

**LEAD ASSIGNMENTS**

- 1 = GATE      3 = SOURCE
- 2 = DRAIN    4 = DRAIN

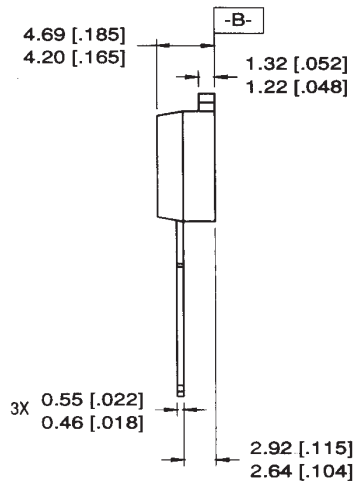

**NOTES:**

1. DIMENSIONING & TOLERANCING PER ANSI Y14.5M-1982
2. CONTROLLING DIMENSION: INCH.
3. DIMENSIONS ARE SHOWN IN MILLIMETERS [INCHES].
4. HEATSINK & LEAD DIMENSIONS DO NOT INCLUDE BURRS.

**Part Marking**

EXAMPLE: THIS IS AN IRL3103L  
 LOT CODE 1789  
 ASSEMBLED ON WW 19, 1997  
 IN THE ASSEMBLY LINE "C"

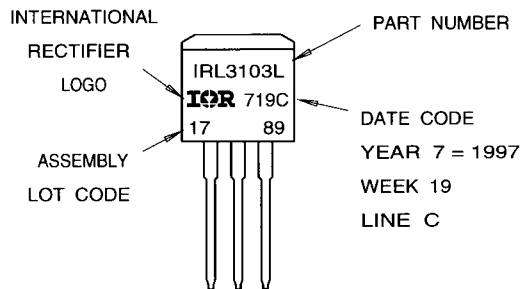

# IRL1104S/L

International  
**IR** Rectifier

## D<sup>2</sup>Pak Tape and Reel

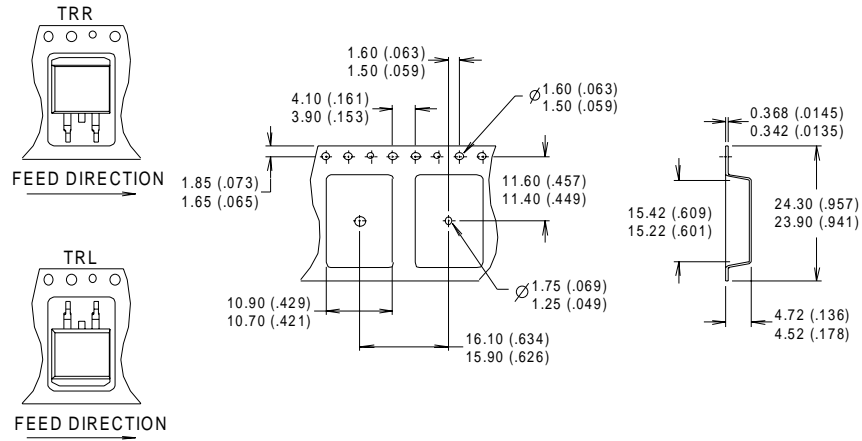

- NOTES :
1. CONFORMS TO EIA-418.
  2. CONTROLLING DIMENSION: MILLIMETER.
  - ③ DIMENSION MEASURED @ HUB.
  - ④ INCLUDES FLANGE DISTORTION @ OUTER EDGE.

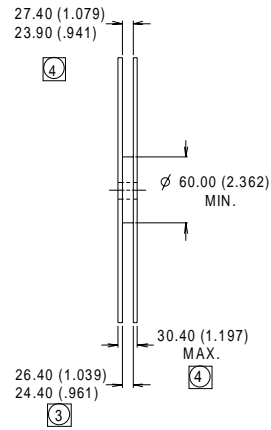

International  
**IR** Rectifier

**WORLD HEADQUARTERS:** 233 Kansas St., El Segundo, California 90245, Tel: (310) 322 3331

**IR GREAT BRITAIN:** Hurst Green, Oxted, Surrey RH8 9BB, UK Tel: ++ 44 1883 732020

**IR CANADA:** 15 Lincoln Court, Brampton, Ontario L6T3Z2, Tel: (905) 453 2200

**IR GERMANY:** Saalburgstrasse 157, 61350 Bad Homburg Tel: ++ 49 6172 96590

**IR ITALY:** Via Liguria 49, 10071 Borgaro, Torino Tel: ++ 39 11 451 0111

**IR FAR EAST:** K&H Bldg., 2F, 30-4 Nishi-Ikebukuro 3-Chome, Toshima-Ku, Tokyo Japan 171 Tel: 81 3 3983 0086

**IR SOUTHEAST ASIA:** 1 Kim Seng Promenade, Great World City West Tower, 13-11, Singapore 237994 Tel: ++ 65 838 4630

**IR TAIWAN:** 16 Fl. Suite D. 207, Sec. 2, Tun Haw South Road, Taipei, 10673, Taiwan Tel: 886-2-2377-9936

<http://www.irf.com/>

Data and specifications subject to change without notice. 10/98

[www.irf.com](http://www.irf.com)