

CURRENT LIMITING LOW SIDE DRIVER

Features

- Gate drive supply range from 12 to 18V
- Undervoltage lockout
- Current detection and limiting loop to limit driven power transistor current
- Error lead indicates fault conditions and programs shutdown time
- Output in phase with input
- 2.5V, 5V and 15V input logic compatible

Description

The IR2121 is a high speed power MOSFET and IGBT driver with over-current limiting protection circuitry. Latch immune CMOS technology enables ruggedized monolithic construction. Logic inputs are compatible with standard CMOS or LSTTL outputs, down to 2.5V logic. The output driver features a high pulse current buffer stage designed for minimum cross-conduction. The protection circuitry detects over-current in the driven power transistor and limits the gate drive voltage. Cycle-by-cycle shutdown is programmed by an external capacitor which directly controls the time interval between detection of the over-current limiting condition and latched shutdown. The output can be used to drive an N-channel power MOSFET or IGBT in the low side configuration.

Product Summary

| | |
|----------------------------------|-------------------------|
| V_{OFFSET} | 5V max. |
| I_{O+/-} | 1A / 2A |
| V_{OUT} | 12 - 18V |
| V_{CSth} | 230 mV |
| t_{on/off} (typ.) | 150 & 150 ns |

Package

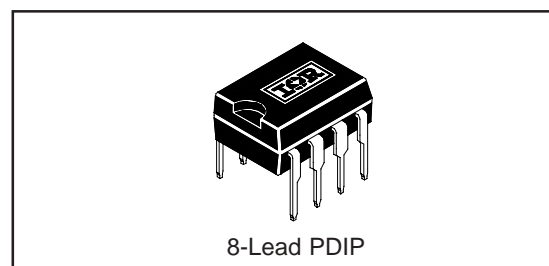

Typical Connection

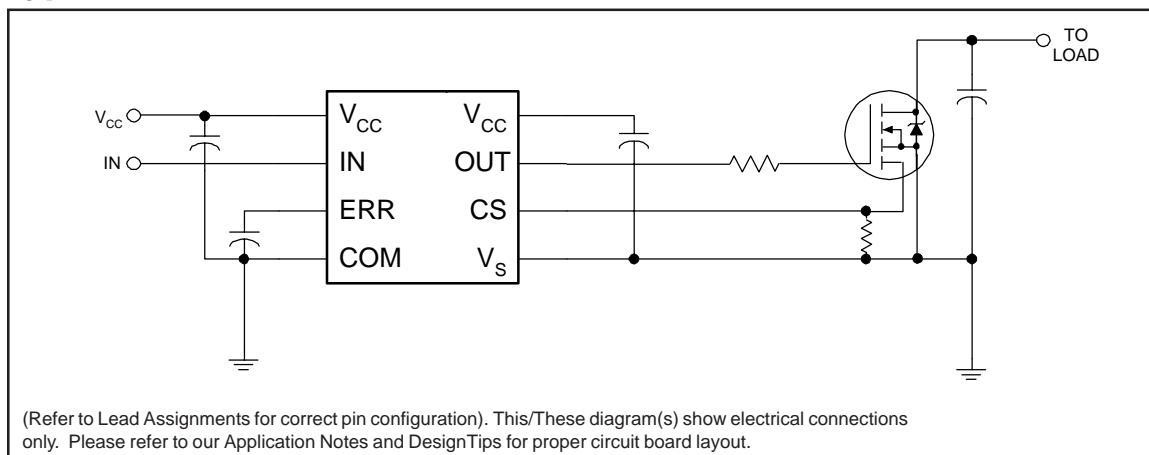

Absolute Maximum Ratings

Absolute Maximum Ratings indicate sustained limits beyond which damage to the device may occur. All voltage parameters are absolute voltages referenced to COM. The Thermal Resistance and Power Dissipation ratings are measured under board mounted and still air conditions.

| Symbol | Parameter Definition | Value | | Units |
|-------------------|--|----------------------|-----------------------|-------|
| | | Min. | Max. | |
| V _{CC} | Fixed Supply Voltage | -0.3 | 25 | V |
| V _S | Gate Drive Return Voltage | V _{CC} - 25 | V _{CC} + 0.3 | |
| V _O | Output Voltage | V _S - 0.3 | V _{CC} + 0.3 | |
| V _{IN} | Logic Input Voltage | -0.3 | V _{CC} + 0.3 | |
| V _{ERR} | Error Signal Voltage | -0.3 | V _{CC} + 0.3 | |
| V _{CS} | Current Sense Voltage | V _S - 0.3 | V _{CC} + 0.3 | |
| P _D | Package Power Dissipation @ T _A ≤ +25°C | — | 1.0 | W |
| R _{thJA} | Thermal Resistance, Junction to Ambient | — | 125 | °C/W |
| T _J | Junction Temperature | — | 150 | °C |
| T _S | Storage Temperature | -55 | 150 | |
| T _L | Lead Temperature (Soldering, 10 seconds) | — | 300 | |

Recommended Operating Conditions

The Input/Output logic timing diagram is shown in Figure 1. For proper operation the device should be used within the recommended conditions. The V_S offset rating is tested with all supplies biased at 15V differential.

| Symbol | Parameter Definition | Value | | Units |
|------------------|------------------------------|---------------------|---------------------|-------|
| | | Min. | Max. | |
| V _{CC} | Fixed Supply Voltage | V _S + 12 | V _S + 18 | V |
| V _S | Gate Drive Return Voltage | -5 | 5 | |
| V _O | Output Voltage | V _S | V _{CC} | |
| V _{IN} | Logic Input Voltage | 0 | V _{CC} | |
| V _{ERR} | Error Signal Voltage | 0 | V _{CC} | |
| V _{CS} | Current Sense Signal Voltage | V _S | V _{CC} | |
| T _A | Ambient Temperature | -40 | 125 | °C |

Dynamic Electrical Characteristics

V_{BIAS} (V_{CC}) = 15V, C_L = 3300 pF and T_A = 25°C unless otherwise specified. The dynamic electrical characteristics are defined in Figures 2 through 5.

| Symbol | Parameter Definition | Figure | Value | | | Units | Test Conditions |
|-----------|-------------------------------------|--------|-------|------|------|---------|-----------------------------|
| | | | Min. | Typ. | Max. | | |
| t_{on} | Turn-On Propagation Delay | 7 | — | 150 | 200 | ns | $V_{IN} = 0 \text{ \& } 5V$ |
| t_{off} | Turn-Off Propagation Delay | 8 | — | 200 | 250 | | |
| t_{sd} | ERR Shutdown Propagation Delay | 9 | — | 1.7 | 2.2 | μs | |
| t_r | Turn-On Rise Time | 10 | — | 43 | 60 | ns | |
| t_f | Turn-Off Fall Time | 11 | — | 26 | 35 | | |
| t_{cs} | CS Shutdown Propagation Delay | 12 | — | 0.7 | 1.2 | μs | $C_{ERR} = 270 \text{ pF}$ |
| t_{err} | CS to ERR Pull-Up Propagation Delay | 13 | — | 9.0 | 12 | | |

Static Electrical Characteristics

V_{BIAS} (V_{CC}) = 15V and T_A = 25°C unless otherwise specified. The V_{IN} , V_{TH} and I_{IN} parameters are referenced to COM. The V_O and I_O parameters are referenced to V_S .

| Symbol | Parameter Definition | Figure | Value | | | Units | Test Conditions |
|-------------|---|--------|-------|------|------|---------|--|
| | | | Min. | Typ. | Max. | | |
| V_{IH} | Logic "1" Input Voltage | 14 | 2.2 | — | — | V | |
| V_{IL} | Logic "0" Input Voltage | 15 | — | — | 0.8 | | |
| V_{CSTH+} | CS Input Positive Going Threshold | 16 | 150 | 230 | 320 | mV | |
| V_{CSTH-} | CS Input Negative Going Threshold | 17 | 130 | 210 | 300 | | |
| V_{OH} | High Level Output Voltage, $V_{BIAS} - V_O$ | 18 | — | — | 100 | | $I_O = 0A$ |
| V_{OL} | Low Level Output Voltage, V_O | 19 | — | — | 100 | | $I_O = 0A$ |
| I_{QCC} | Quiescent VCC Supply Current | 20 | — | 1.1 | 2.2 | mA | $V_{IN} = V_{CS} = 0V \text{ or } 5V$ |
| I_{IN+} | Logic "1" Input Bias Current | 21 | — | 4.5 | 10 | μA | $V_{IN} = 5V$ |
| I_{IN-} | Logic "0" Input Bias Current | 22 | — | — | 1.0 | | $V_{IN} = 0V$ |
| I_{CS+} | "High" CS Bias Current | 23 | — | 4.5 | 10 | | $V_{CS} = 3V \text{ or } 5V$ |
| I_{CS-} | "Low" CS Bias Current | 24 | — | — | 1.0 | | $V_{CS} = 0V$ |
| V_{CCUV+} | V_{CC} Supply Undervoltage Positive Going Threshold | 25 | 8.3 | 8.9 | 9.6 | V | |
| V_{CCUV-} | V_{CC} Supply Undervoltage Negative Going Threshold | 26 | 7.3 | 8.0 | 8.7 | | |
| I_{ERR} | ERR Timing Charge Current | 27 | 65 | 100 | 130 | μA | $V_{IN} = 5V, V_{CS} = 3V$ $ERR < V_{ERR+}$ |
| I_{ERR+} | ERR Pull-Up Current | 28 | 8.0 | 15 | — | mA | $V_{IN} = 5V, V_{CS} = 3V$ $ERR > V_{ERR+}$ |
| I_{ERR-} | ERR Pull-Down Current | 29 | 16 | 30 | — | | $V_{IN} = 0V$ |
| I_{O+} | Output High Short Circuit Pulsed Current | 30 | 1.0 | 1.6 | — | A | $V_O = 0V, V_{IN} = 5V$ $PW \leq 10 \mu s$ |
| I_{O-} | Output Low Short Circuit Pulsed Current | 31 | 2.0 | 3.3 | — | | $V_O = 15V, V_{IN} = 0V$ $PW \leq 10 \mu s$ |

IR2121

Functional Block Diagram

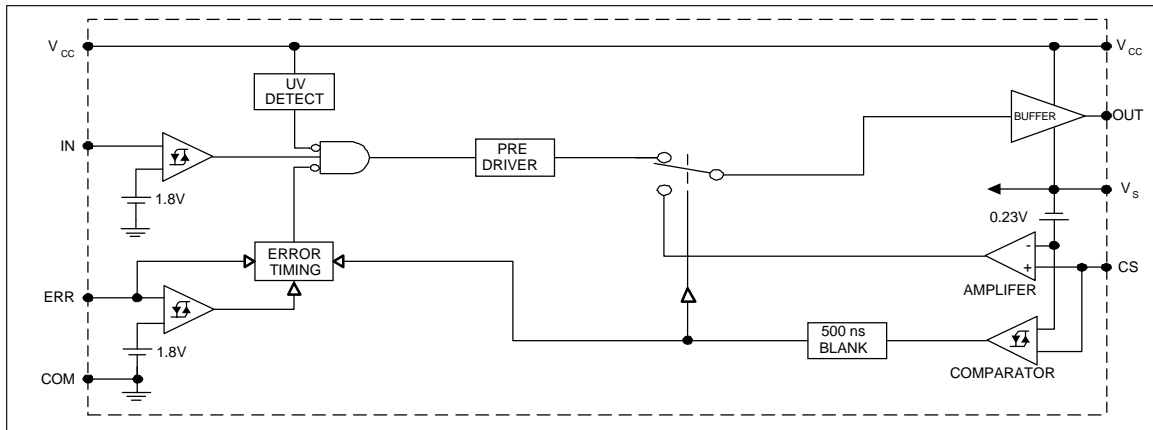

Lead Definitions

| Lead | |
|-----------------|---|
| Symbol | Description |
| V _{CC} | Logic and gate drive supply |
| IN | Logic input for gate driver output (OUT), in phase with OUT |
| ERR | Serves multiple functions; status reporting, linear mode timing and cycle by cycle logic shutdown |
| COM | Logic ground |
| OUT | Gate drive output |
| V _S | Gate drive supply return |
| CS | Current sense input to current sense comparator |

Lead Assignments

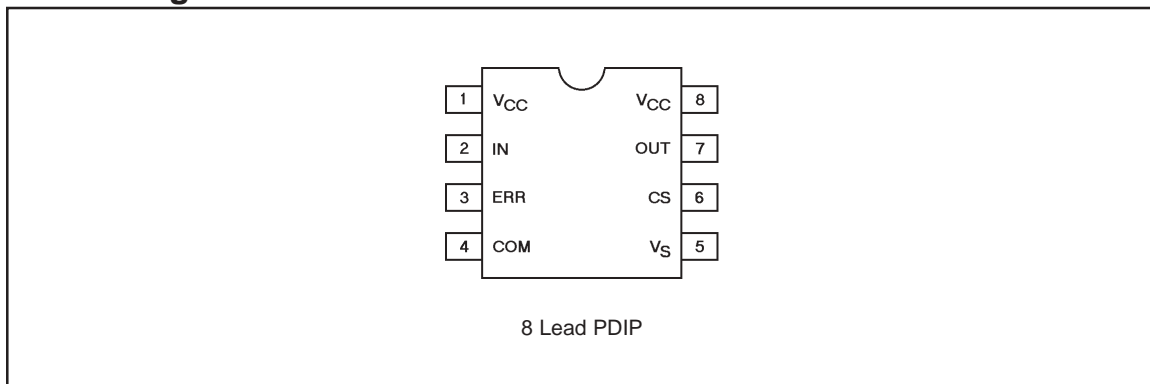

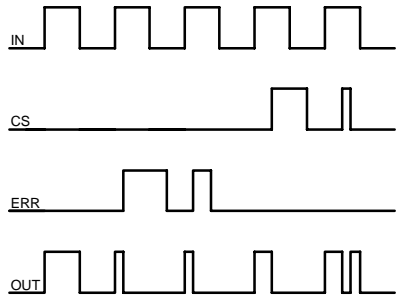

Figure 1. Input/Output Timing Diagram

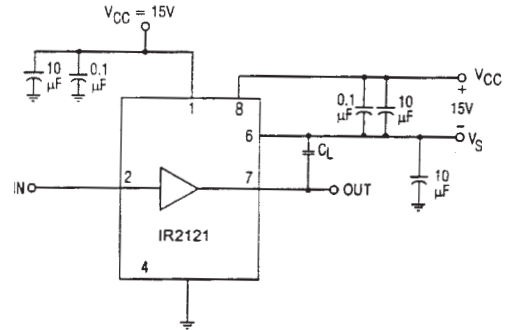

Figure 2. Switching Time Test Circuit

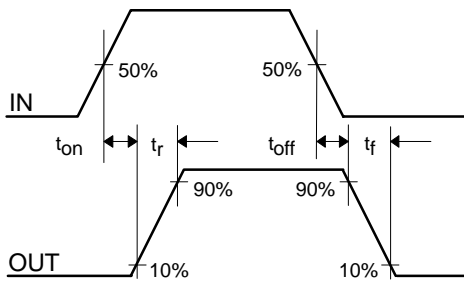

Figure 3. Switching Time Waveform Definitions

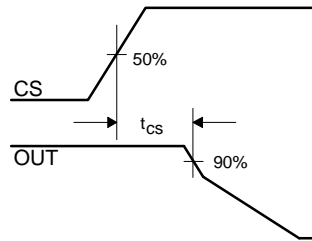

Figure 4. ERR Shutdown Waveform Definitions

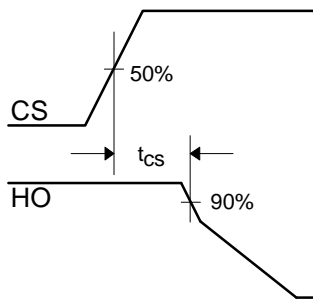
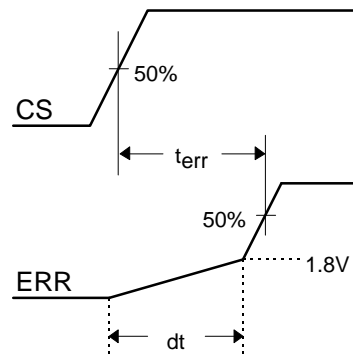

Figure 5. CS Shutdown Waveform Definitions



$$dt = C \times \frac{dV}{I_{ERR}} = C \times \frac{1.8V}{100 \mu A}$$

Figure 6. CS to ERR Waveform Definitions

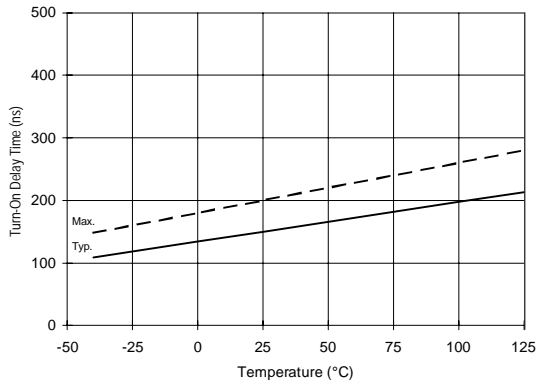

Figure 7A. Turn-On Time vs. Temperature

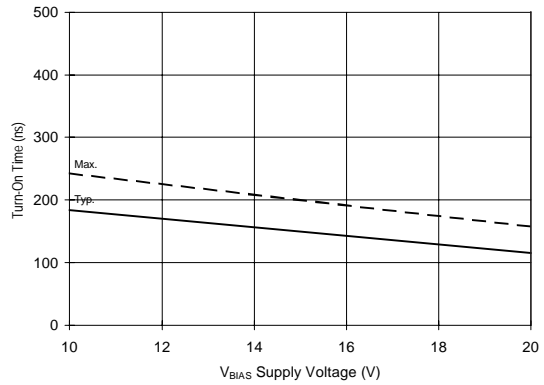

Figure 7B. Turn-On Time vs. Voltage

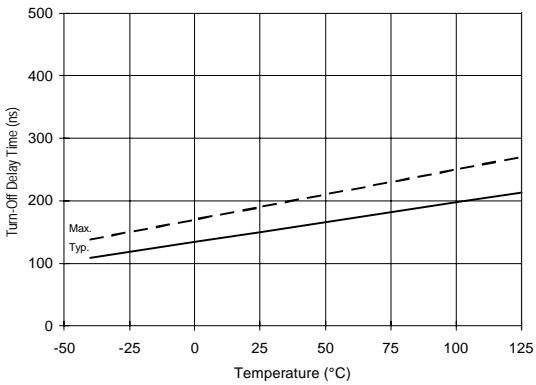

Figure 8A. Turn-Off Time vs. Temperature

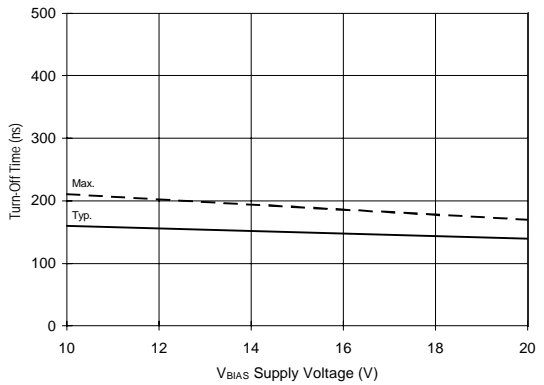

Figure 8B. Turn-Off Time vs. Voltage

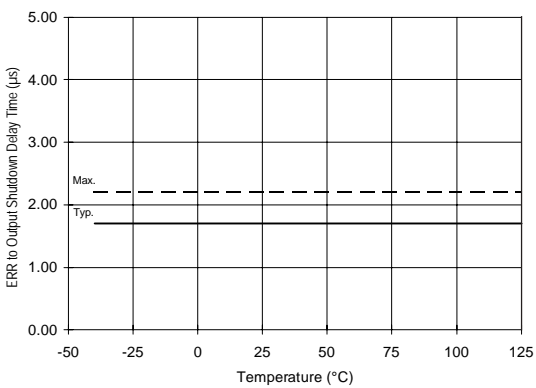

Figure 9A. ERR to Output Shutdown vs. Temperature

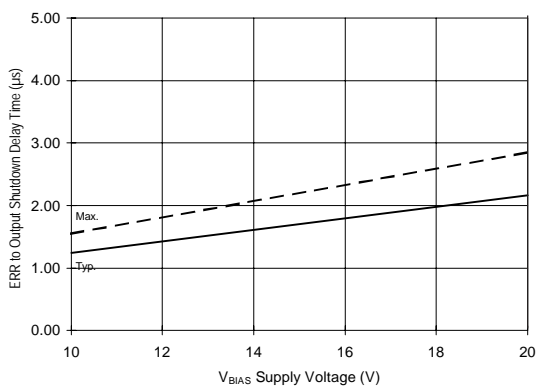

Figure 9B. ERR to Output Shutdown vs. Voltage

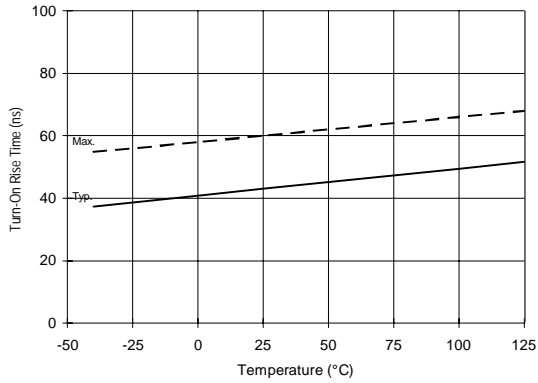

Figure 10A. Turn-On Rise Time vs. Temperature

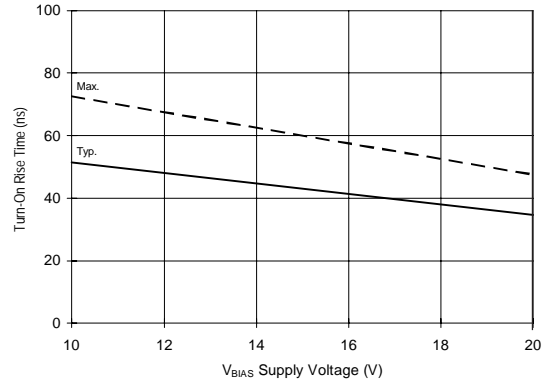

Figure 10B. Turn-On Rise Time vs. Voltage

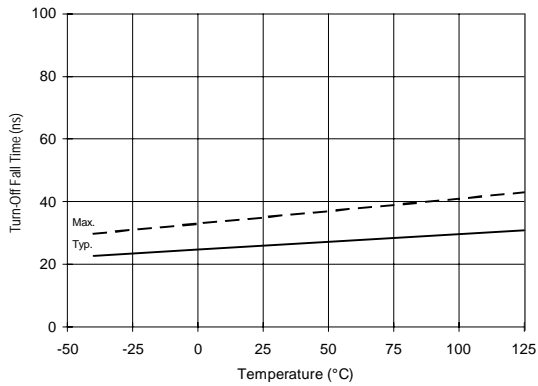

Figure 11A. Turn-Off Fall Time vs. Temperature

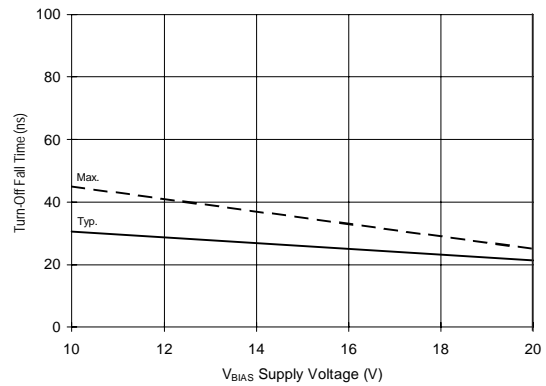

Figure 11B. Turn-Off Fall Time vs. Voltage

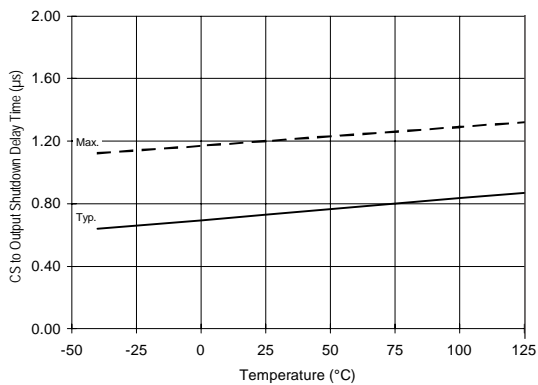

Figure 12A. CS to Output Shutdown vs. Temperature

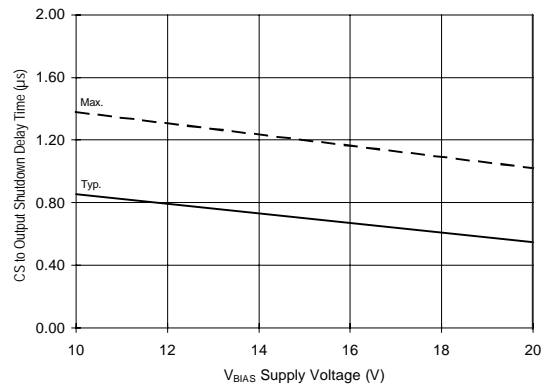

Figure 12B. CS to Output Shutdown vs. Voltage

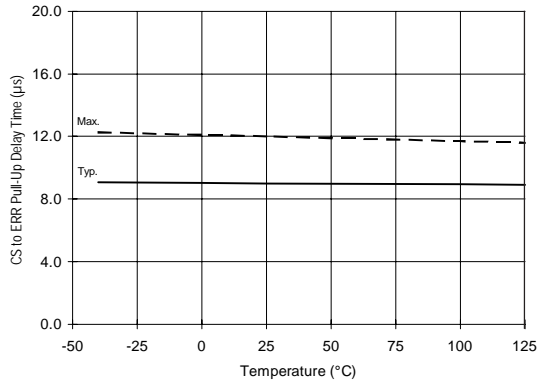

Figure 13A. CS to ERR Pull-Up vs. Temperature

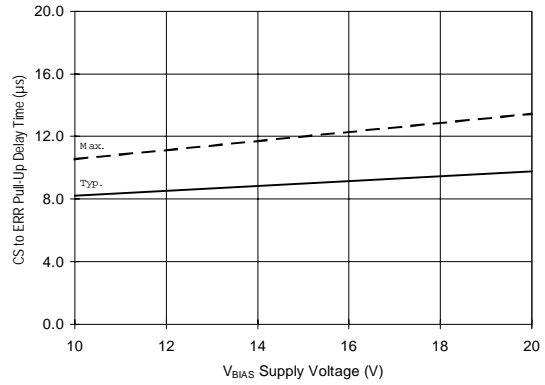

Figure 13B. CS to ERR Pull-Up vs. Voltage

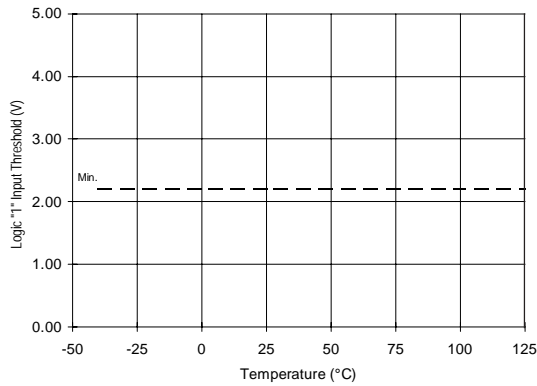

Figure 14A. Logic "1" Input Threshold vs. Temperature

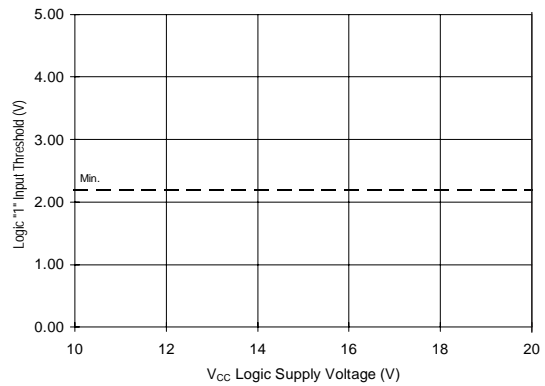

Figure 14B. Logic "1" Input Threshold vs. Voltage

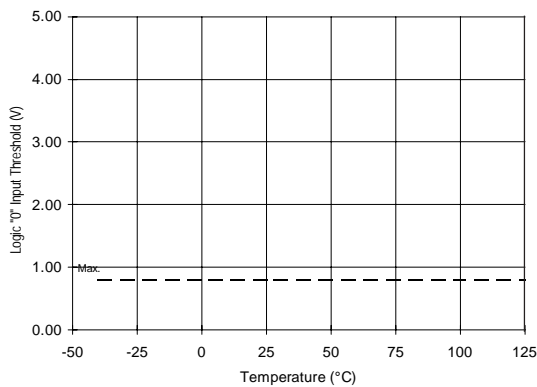

Figure 15A. Logic "0" Input Threshold vs. Temperature

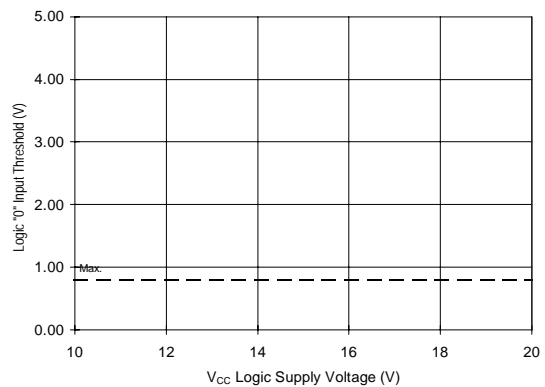

Figure 15B. Logic "0" Input Threshold vs. Voltage

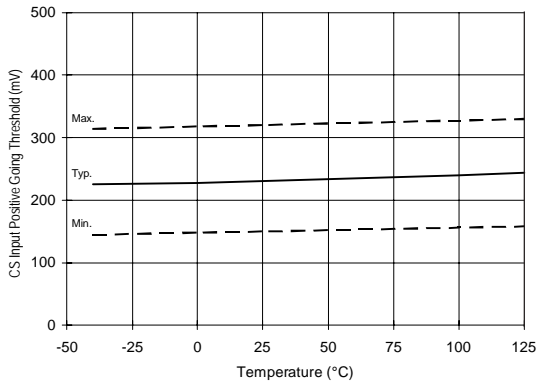

Figure 16A. CS Input Threshold (+) vs. Temperature

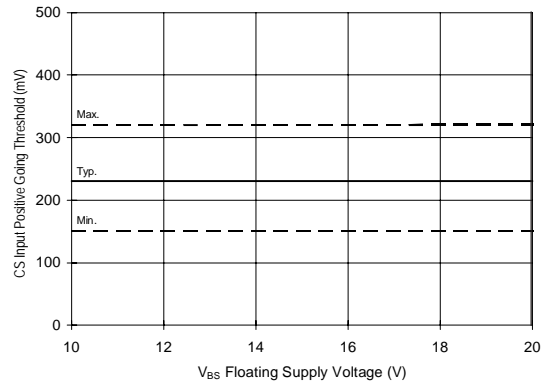

Figure 16B. CS Input Threshold (+) vs. Voltage

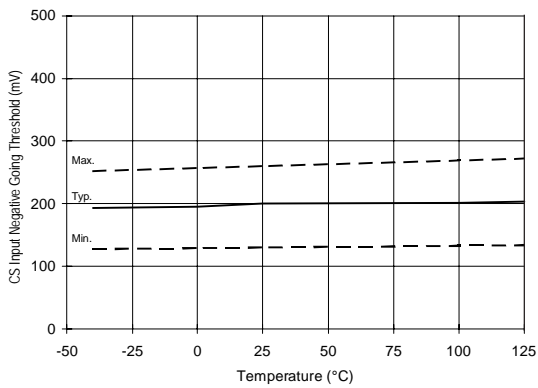

Figure 17A. CS Input Threshold (-) vs. Temperature

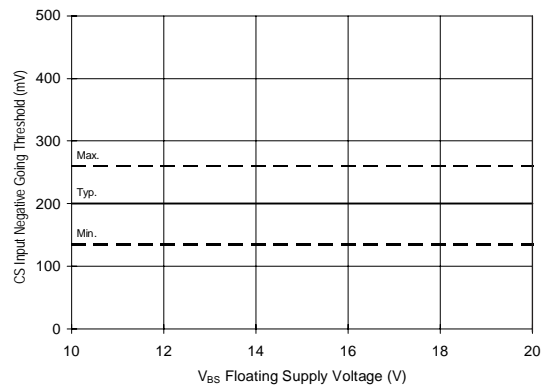

Figure 17B. CS Input Threshold (-) vs. Voltage

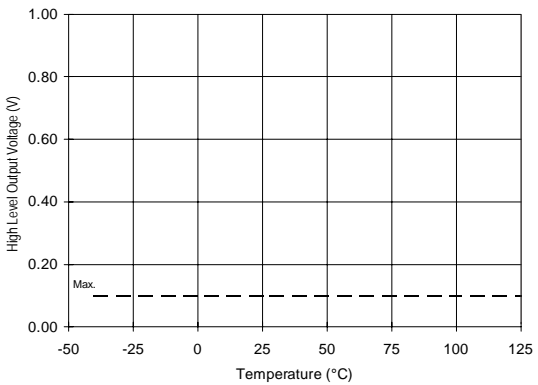

Figure 18A. High Level Output vs. Temperature

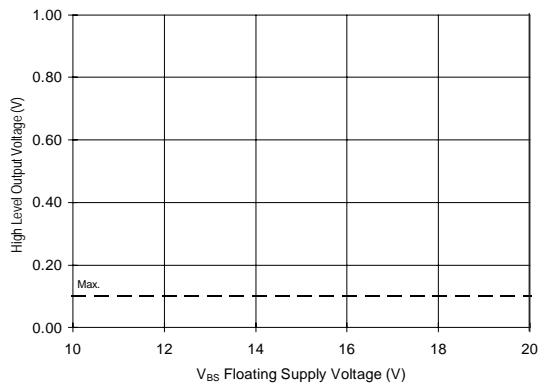

Figure 18B. High Level Output vs. Voltage

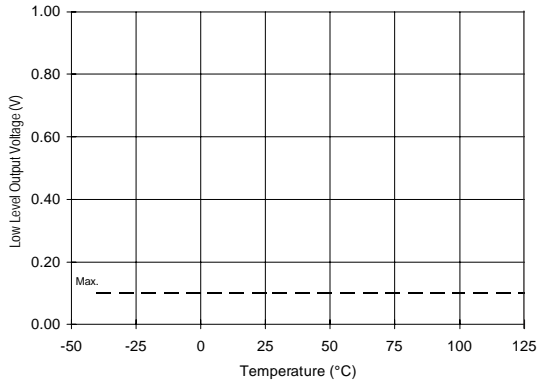

Figure 19A. Low Level Output vs. Temperature

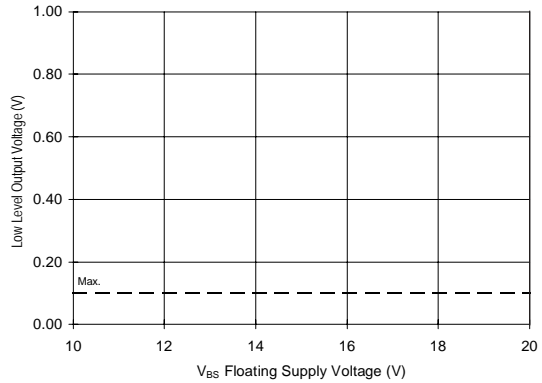

Figure 19B. Low Level Output vs. Voltage

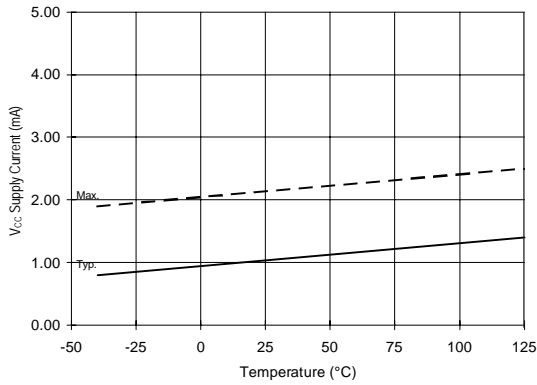

Figure 20A. V_{CC} Supply Current vs. Temperature

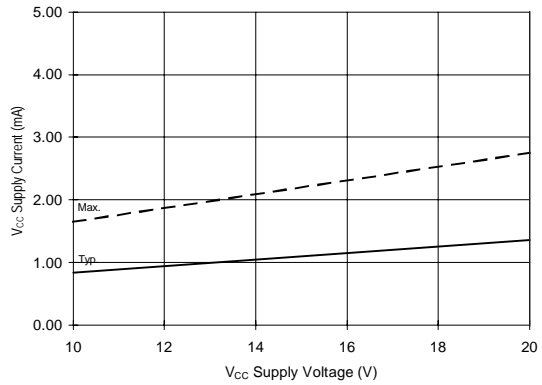

Figure 20B. V_{CC} Supply Current vs. Voltage

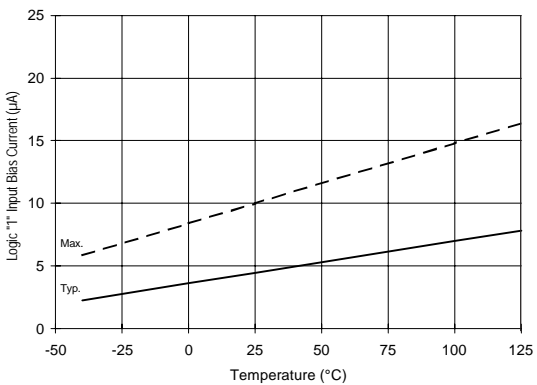

Figure 21A. Logic "1" Input Current vs. Temperature

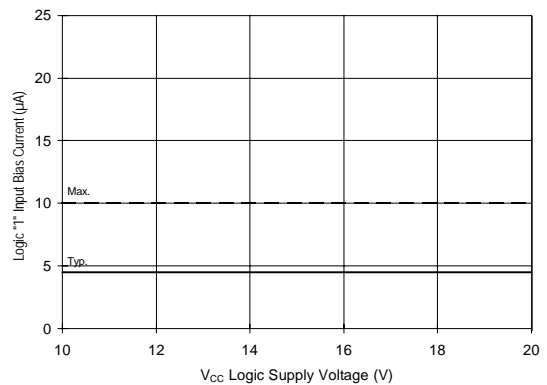

Figure 21B. Logic "1" Input Current vs. Voltage

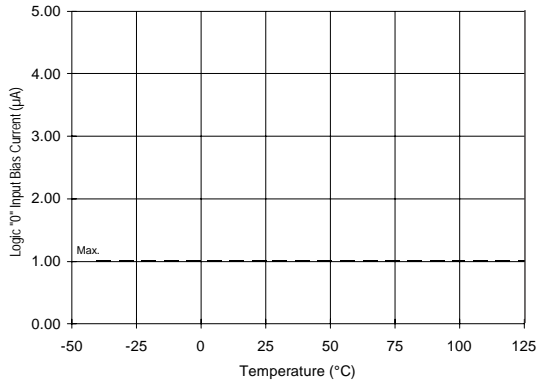

Figure 22A. Logic "0" Input Current vs. Temperature

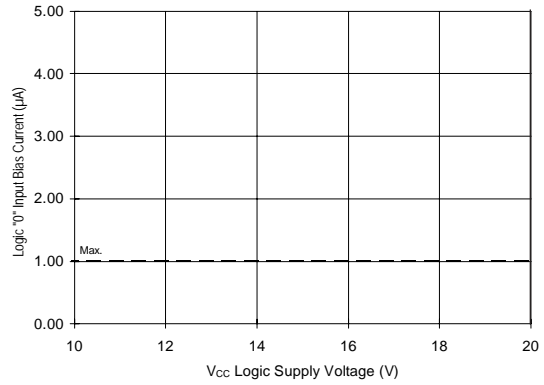

Figure 22B. Logic "0" Input Current vs. Voltage

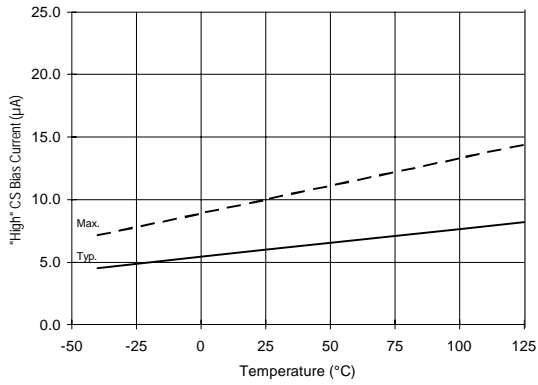

Figure 23A. "High" CS Bias Current vs. Temperature

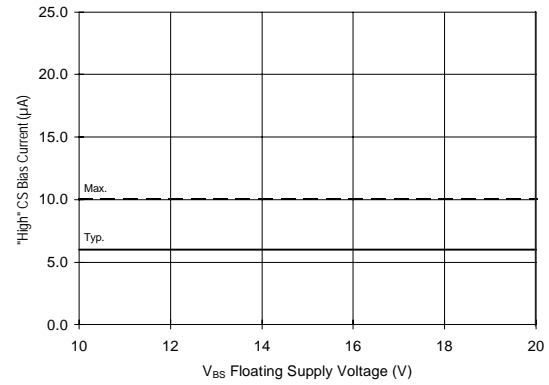

Figure 23B. "High" CS Bias Current vs. Voltage

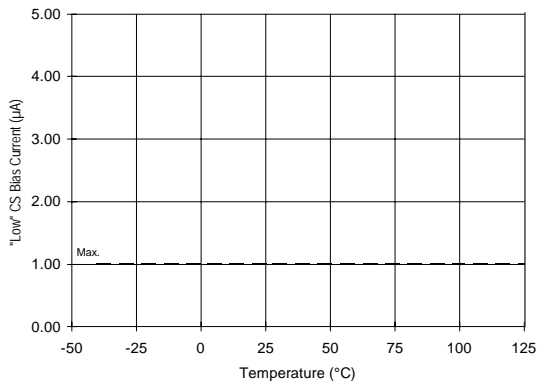

Figure 24A. "Low" CS Bias Current vs. Temperature

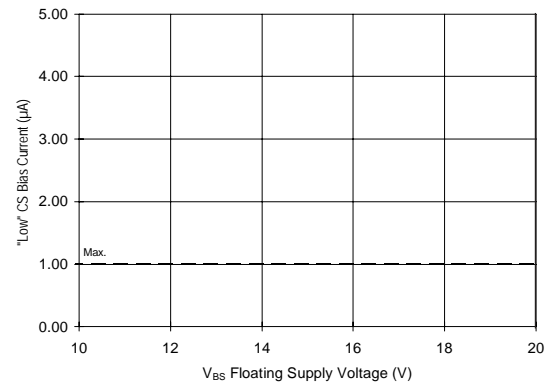

Figure 24B. "Low" CS Bias Current vs. Voltage

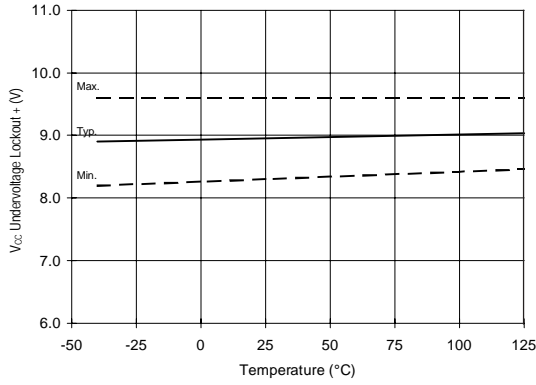

Figure 25. V_{CC} Undervoltage (+) vs. Temperature

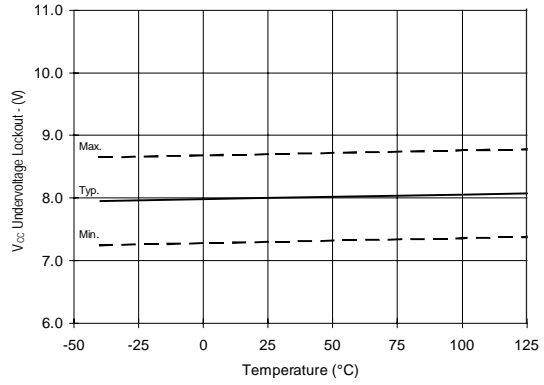

Figure 26. V_{CC} Undervoltage (-) vs. Temperature

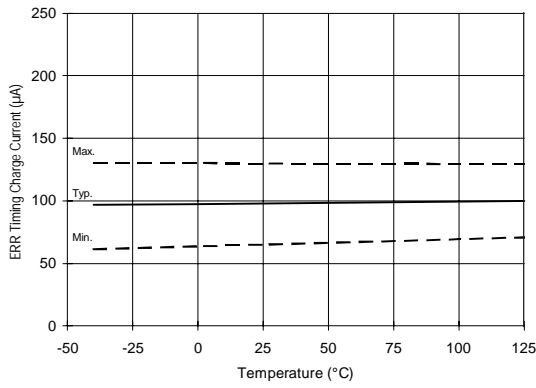

Figure 27A. ERR Timing Charge Current vs. Temperature

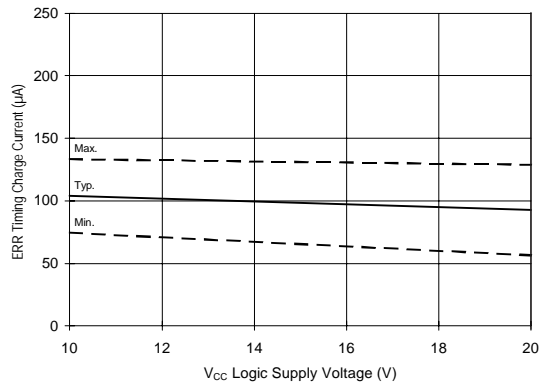

Figure 27B. ERR Timing Charge Current vs. Voltage

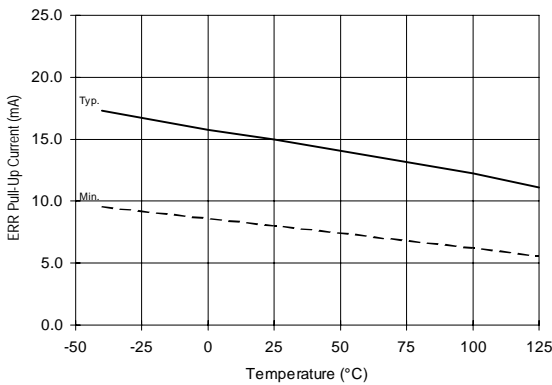

Figure 28A. ERR Pull-Up Current vs. Temperature

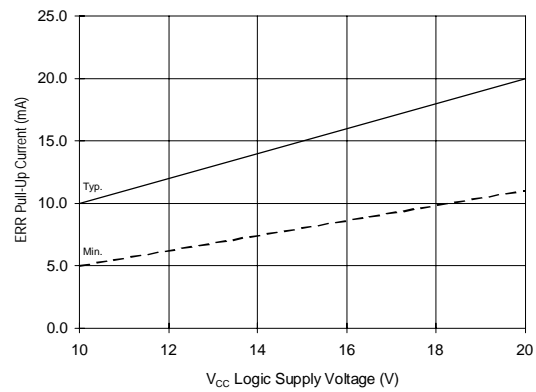

Figure 28B. ERR Pull-Up Current vs. Voltage

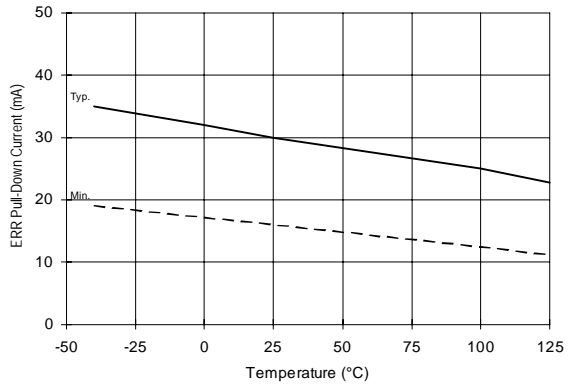

Figure 29A. ERR Pull-Down Current vs. Temperature

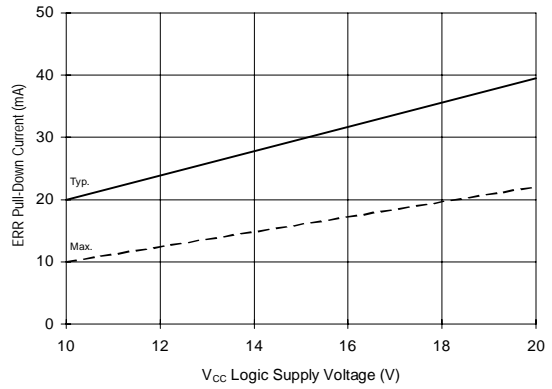

Figure 29B. ERR Pull-Down Current vs. Voltage

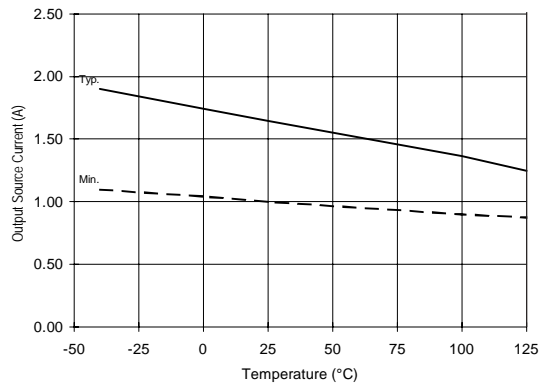

Figure 30A. Output Source Current vs. Temperature

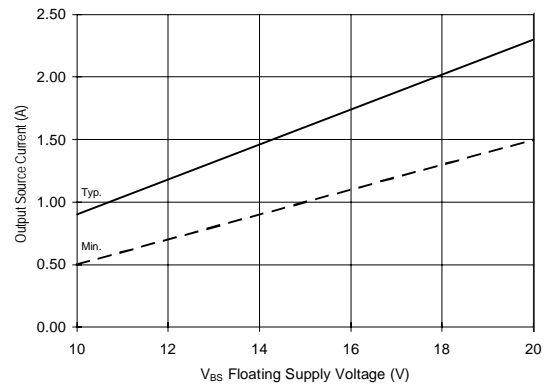

Figure 30B. Output Source Current vs. Voltage

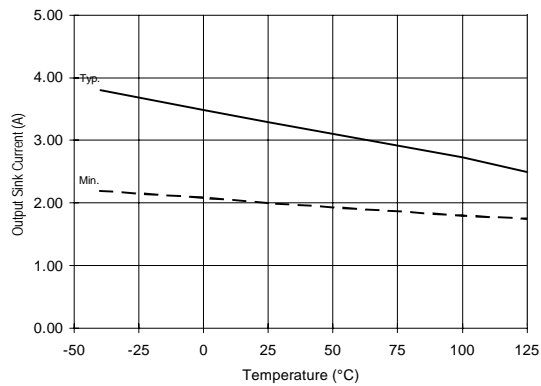

Figure 31A. Output Sink Current vs. Temperature

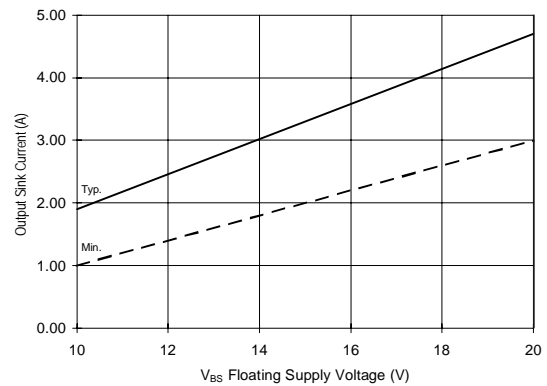

Figure 31B. Output Sink Current vs. Voltage

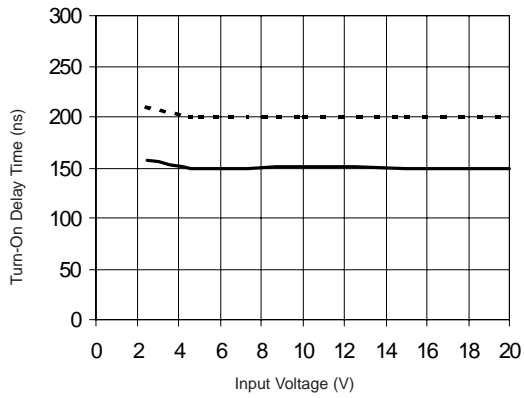

Figure 32A. Turn-On Time vs. Input Voltage

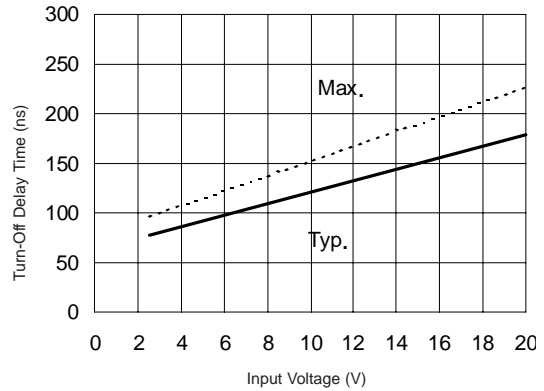

Figure 32B. Turn-Off Time vs. Input Voltage

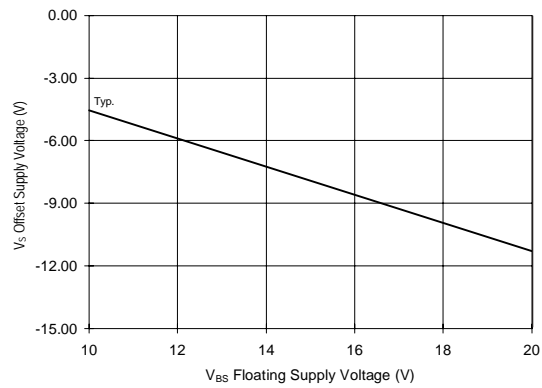
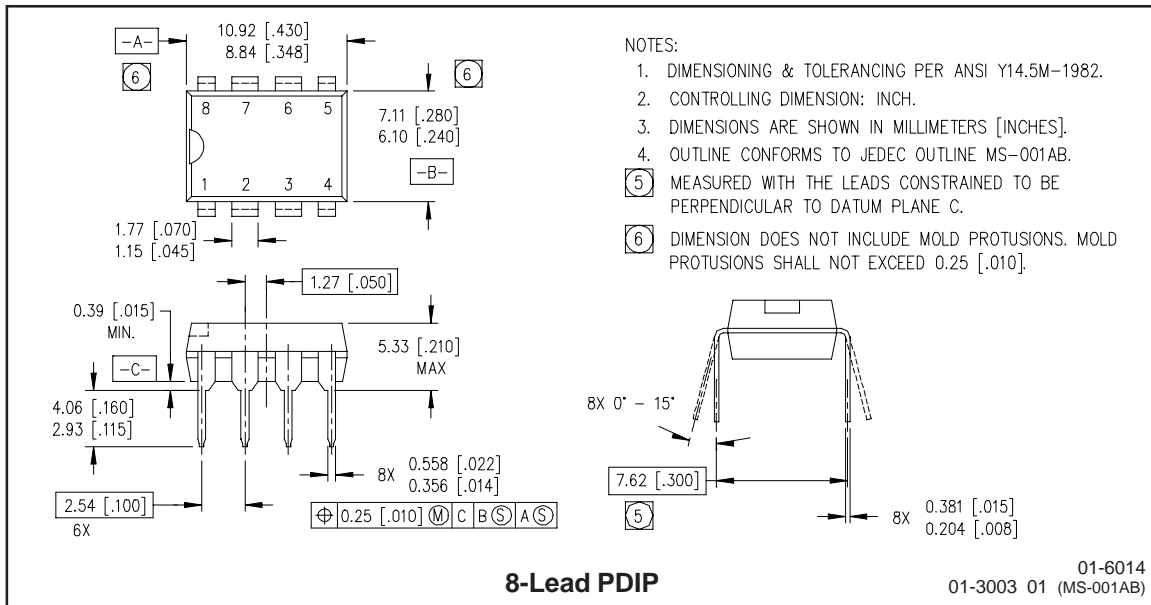

Figure 33. Maximum V_S Negative Offset vs. Supply Voltage

Case outline



- NOTES:
1. DIMENSIONING & TOLERANCING PER ANSI Y14.5M-1982.
 2. CONTROLLING DIMENSION: INCH.
 3. DIMENSIONS ARE SHOWN IN MILLIMETERS [INCHES].
 4. OUTLINE CONFORMS TO JEDEC OUTLINE MS-001AB.
 - 5 MEASURED WITH THE LEADS CONSTRAINED TO BE PERPENDICULAR TO DATUM PLANE C.
 - 6 DIMENSION DOES NOT INCLUDE MOLD PROTUSIONS. MOLD PROTUSIONS SHALL NOT EXCEED 0.25 [.010].