

MC74HCT14A

Hex Schmitt-Trigger Inverter with LSTTL Compatible Inputs

High-Performance Silicon-Gate CMOS

The MC74HCT14A may be used as a level converter for interfacing TTL or NMOS outputs to high-speed CMOS inputs.

The HCT14A is useful to “square up” slow input rise and fall times. Due to the hysteresis voltage of the Schmitt trigger, the HCT14A finds applications in noisy environments.

- Output Drive Capability: 10 LSTTL Loads
- TTL/NMOS-Compatible Input Levels
- Outputs Directly Interface to CMOS, NMOS, and TTL
- Operating Voltage Range: 4.5 to 5.5 V
- Low Input Current: 1.0 μ A
- In Compliance with the Requirements Defined by JEDEC Standard No. 7A
- Chip Complexity: 72 FETs or 18 Equivalent Gates



ON Semiconductor®

<http://onsemi.com>

MARKING DIAGRAMS

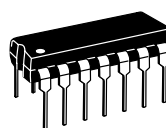

PDIP-14
N SUFFIX
CASE 646

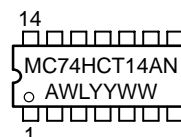

SOIC-14
D SUFFIX
CASE 751A

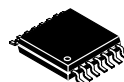
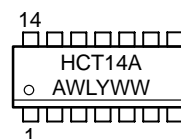

TSSOP-14
DT SUFFIX
CASE 948G

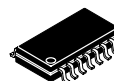
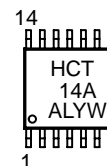

EIAJ-14
F SUFFIX
CASE 965

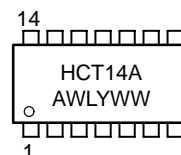

A = Assembly Location
L, WL = Wafer Lot
Y, YY = Year
W, WW = Work Week

ORDERING INFORMATION

Device	Package	Shipping
MC74HCT14AN	PDIP-14	2000/Box
MC74HCT14AD	SOIC-14	55/Rail
MC74HCT14ADR2	SOIC-14	2500/Reel
MC74HCT14ADTR2	TSSOP-14	2000/Reel
MC74HCT14AFEL	EIAJ-14	2000/Reel

MC74HCT14A

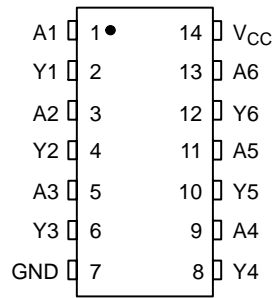

FUNCTION TABLE

Input A	Output Y
L	H
H	L

Figure 1. Pin Assignment

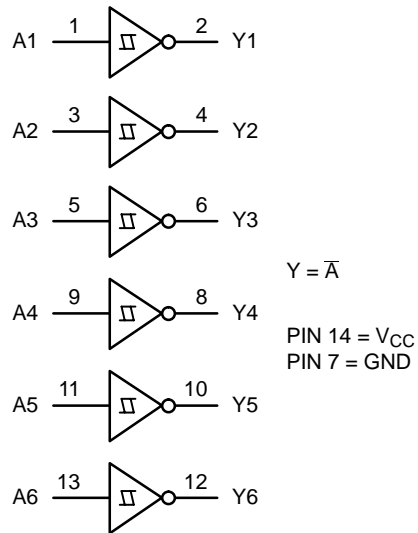

Figure 2. Logic Diagram

MC74HCT14A

MAXIMUM RATINGS (Note 1)

Symbol	Parameter	Value	Unit
V _{CC}	DC Supply Voltage (Referenced to GND)	-0.5 to +7.0	V
V _I	DC Input Voltage (Referenced to GND)	-0.5 to V _{CC} + 0.5	V
V _O	DC Output Voltage (Referenced to GND)	-0.5 to V _{CC} + 0.5	V
I _{IK}	DC Input Diode Current	±20	mA
I _{OK}	DC Output Diode Current	±25	mA
I _O	DC Output Sink Current	±25	mA
I _{CC}	DC Supply Current per Supply Pin	±50	mA
I _{GND}	DC Ground Current per Ground Pin	±50	mA
T _{STG}	Storage Temperature Range	-65 to +150	°C
T _L	Lead Temperature, 1 mm from Case for 10 Seconds	260	°C
T _J	Junction Temperature under Bias	+150	°C
θ _{JA}	Thermal Resistance	PDIP SOIC TSSOP 78 125 170	°C/W
P _D	Power Dissipation in Still Air at 85°C	PDIP SOIC TSSOP 750 500 450	mW
MSL	Moisture Sensitivity	Level 1	
F _R	Flammability Rating Oxygen Index: 30% - 35%	UL-94-VO (0.125 in)	
V _{ESD}	ESD Withstand Voltage	Human Body Model (Note 2) Machine Model (Note 3) Charged Device Model (Note 4) >4000 >300 >1000	V
I _{Latch-Up}	Latch-Up Performance Above V _{CC} and Below GND at 85°C (Note 5)	±300	mA

1. Absolute maximum continuous ratings are those values beyond which damage to the device may occur. Extended exposure to these conditions or conditions beyond those indicated may adversely affect device reliability. Functional operation under absolute maximum-rated conditions is not implied.
2. Tested to EIA/JESD22-A114-A.
3. Tested to EIA/JESD22-A115-A.
4. Tested to JESD22-C101-A.
5. Tested to EIA/JESD78.
6. For high frequency or heavy load considerations, see the ON Semiconductor High-Speed CMOS Data Book (DL129/D).

RECOMMENDED OPERATING CONDITIONS

Symbol	Parameter	Min	Max	Unit
V _{CC}	DC Supply Voltage (Referenced to GND)	4.5	5.5	V
V _I , V _O	DC Input Voltage, Output Voltage (Referenced to GND)	0	V _{CC}	V
T _A	Operating Temperature, All Package Types	-55	+125	°C
t _r , t _f	Input Rise and Fall Time (Figure 3)	—	(Note 7)	ns

7. No Limit when V_I ≈ 50% V_{CC}, I_{CC} > 1 mA.
8. Unused inputs may not be left open. All inputs must be tied to a high-logic voltage level or a low-logic input voltage level.

MC74HCT14A

DC ELECTRICAL CHARACTERISTICS (Voltages Referenced to GND)

Symbol	Parameter	Test Conditions	V _{CC} Volts	Temperature Limit						Unit
				-55°C to 25°C		≤ 85°C		≤ 125°C		
				Min	Max	Min	Max	Min	Max	
V _{T+} max	Maximum Positive-Going Input Threshold Voltage	V _O = 0.1 V or V _{CC} - 0.1 V I _{out} ≤ 20 μA	4.5 5.5		1.9 2.1		1.9 2.1		1.9 2.1	V
V _{T+} min	Minimum Positive-Going Input Threshold Voltage	V _O = 0.1 V or V _{CC} - 0.1 V I _{out} ≤ 20 μA	4.5 5.5	1.2 1.4		1.2 1.4		1.2 1.4		V
V _{T-} max	Maximum Negative-Going Input Threshold Voltage	V _O = 0.1 V or V _{CC} - 0.1 V I _{out} ≤ 20 μA	4.5 5.5		1.2 1.4		1.2 1.4		1.2 1.4	
V _{T-} min	Minimum Negative-Going Input Threshold Voltage	V _O = 0.1 V or V _{CC} - 0.1 V I _{out} ≤ 20 μA	4.5 5.5	0.5 0.6		0.5 0.6		0.5 0.6		
V _H max	Maximum Hysteresis Voltage	V _O = 0.1 V or V _{CC} - 0.1 V I _{out} ≤ 20 μA	4.5 5.5		1.4 1.5		1.4 1.5		1.4 1.5	
V _H min	Minimum Hysteresis Voltage	V _O = 0.1 V or V _{CC} - 0.1 V I _{out} ≤ 20 μA	4.5 5.5	0.4 0.4		0.4 0.4		0.4 0.4		
V _{OH}	Minimum High-Level Output Voltage	V _I < V _{T-} min I _{out} ≤ 20 μA	4.5 5.5	4.4 5.4		4.4 5.4		4.4 5.4		V
		V _I < V _{T-} min I _{out} ≤ 4.0 mA	4.5	3.98		3.84		3.7		
V _{OL}	Maximum Low-Level Output Voltage	V _I ≥ V _{T+} max I _{out} ≤ 20 μA	4.5 5.5		0.1 0.1		0.1 0.1		0.1 0.1	V
		V _I ≥ V _{T+} max I _{out} ≤ 4.0 mA	4.5		0.26		0.33		0.4	
I _{IK}	Maximum Input Leakage Current	V _I = V _{CC} or GND	5.5		±0.1		±1.0		±1.0	μA
I _{CC}	Maximum Quiescent Supply Current (per package)	V _I = V _{CC} or GND I _{out} = 0 μA	5.5		1.0		10		40	μA
ΔI _{CC}	Additional Quiescent Supply Current	V _I = 2.4 V, Any One Input V _I = V _{CC} or GND, Other Inputs I _{out} = 0 μA	5.5	≥ -55°C		25°C to 125°C				mA
				2.9		2.4				

9. Information on typical parametric values can be found in the ON Semiconductor High-Speed CMOS Data Book (DL129/D).

AC CHARACTERISTICS (C_L = 50 pF; Input t_r = t_f = 6.0 ns)

Symbol	Parameter	Test Conditions	Figures	Guaranteed Limit						Unit
				-55°C to 25°C		≤ 85°C		≤ 125°C		
				Min	Max	Min	Max	Min	Max	
t _{PLH} , t _{PHL}	Maximum Propagation Delay, Input A to Output Y (L to H)	V _{CC} = 5.0 V ± 10% C _L = 50 pF, Input t _r = t _f = 6.0 ns	3 & 4		32		40		48	ns
t _{TLH} , t _{THL}	Maximum Output Transition Time, Any Output	V _{CC} = 5.0 V ± 10% C _L = 50 pF, Input t _r = t _f = 6.0 ns	3 & 4		15		19		22	ns

10. For propagation delays with loads other than 50 pF, and information on typical parametric values, see the ON Semiconductor High-Speed CMOS Data Book (DL129/D).

C _{PD}	Power Dissipation Capacitance, per Inverter (Note 11)	Typical @ 25°C, V _{CC} = 5.0 V		pF
		32		

11. Used to determine the no-load dynamic power consumption: P_D = C_{PD} V_{CC}²f + I_{CC} V_{CC}. For load considerations, see the ON Semiconductor High-Speed CMOS Data Book (DL129/D).

MC74HCT14A

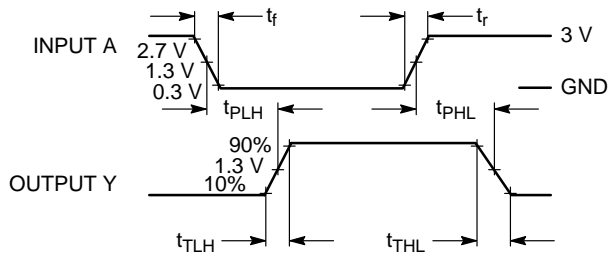
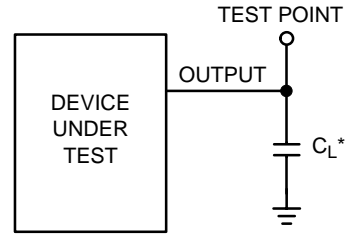

Figure 3. Switching Waveforms



*Includes all probe and jig capacitance.

Figure 4. Test Circuit

MC74HCT14A

PACKAGE DIMENSIONS

PDIP-14
N SUFFIX
CASE 646-06
ISSUE M

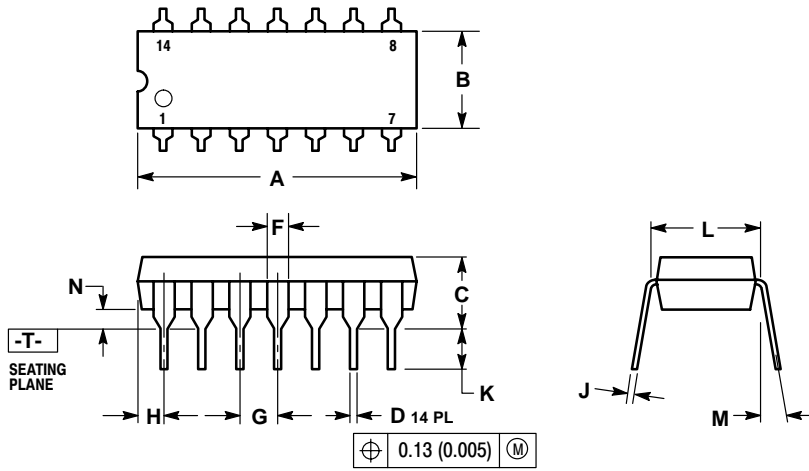

NOTES:

1. DIMENSIONING AND TOLERANCING PER ANSI Y14.5M, 1982.
2. CONTROLLING DIMENSION: INCH.
3. DIMENSION L TO CENTER OF LEADS WHEN FORMED PARALLEL.
4. DIMENSION B DOES NOT INCLUDE MOLD FLASH.
5. ROUNDED CORNERS OPTIONAL.

DIM	INCHES		MILLIMETERS	
	MIN	MAX	MIN	MAX
A	0.715	0.770	18.16	18.80
B	0.240	0.260	6.10	6.60
C	0.145	0.185	3.69	4.69
D	0.015	0.021	0.38	0.53
F	0.040	0.070	1.02	1.78
G	0.100 BSC 2.54 BSC			
H	0.052	0.095	1.32	2.41
J	0.008	0.015	0.20	0.38
K	0.115	0.135	2.92	3.43
L	0.290	0.310	7.37	7.87
M	---	10°	---	10°
N	0.015	0.039	0.38	1.01

SOIC-14
D SUFFIX
CASE 751A-03
ISSUE F

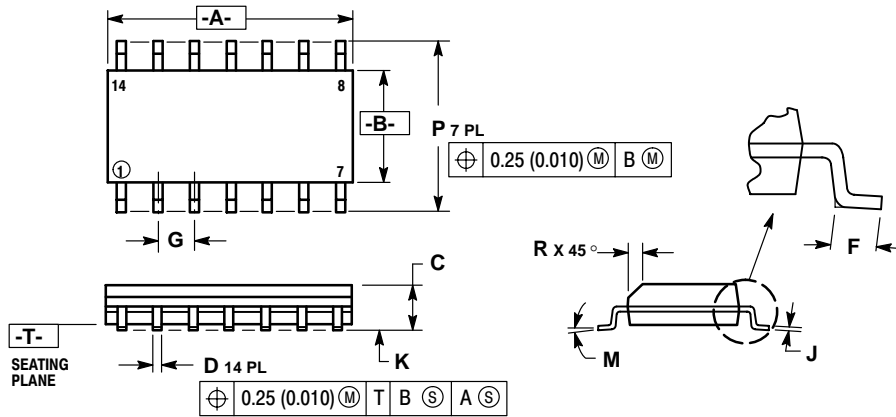

NOTES:

1. DIMENSIONING AND TOLERANCING PER ANSI Y14.5M, 1982.
2. CONTROLLING DIMENSION: MILLIMETER.
3. DIMENSIONS A AND B DO NOT INCLUDE MOLD PROTRUSION.
4. MAXIMUM MOLD PROTRUSION 0.15 (0.006) PER SIDE.
5. DIMENSION D DOES NOT INCLUDE DAMBAR PROTRUSION. ALLOWABLE DAMBAR PROTRUSION SHALL BE 0.127 (0.005) TOTAL IN EXCESS OF THE D DIMENSION AT MAXIMUM MATERIAL CONDITION.

DIM	MILLIMETERS		INCHES	
	MIN	MAX	MIN	MAX
A	8.55	8.75	0.337	0.344
B	3.80	4.00	0.150	0.157
C	1.35	1.75	0.054	0.068
D	0.35	0.49	0.014	0.019
F	0.40	1.25	0.016	0.049
G	1.27 BSC 0.050 BSC			
J	0.19	0.25	0.008	0.009
K	0.10	0.25	0.004	0.009
M	0°	7°	0°	7°
P	5.80	6.20	0.228	0.244
R	0.25	0.50	0.010	0.019

MC74HCT14A

PACKAGE DIMENSIONS

TSSOP-14
DT SUFFIX
CASE 948G-01
ISSUE O

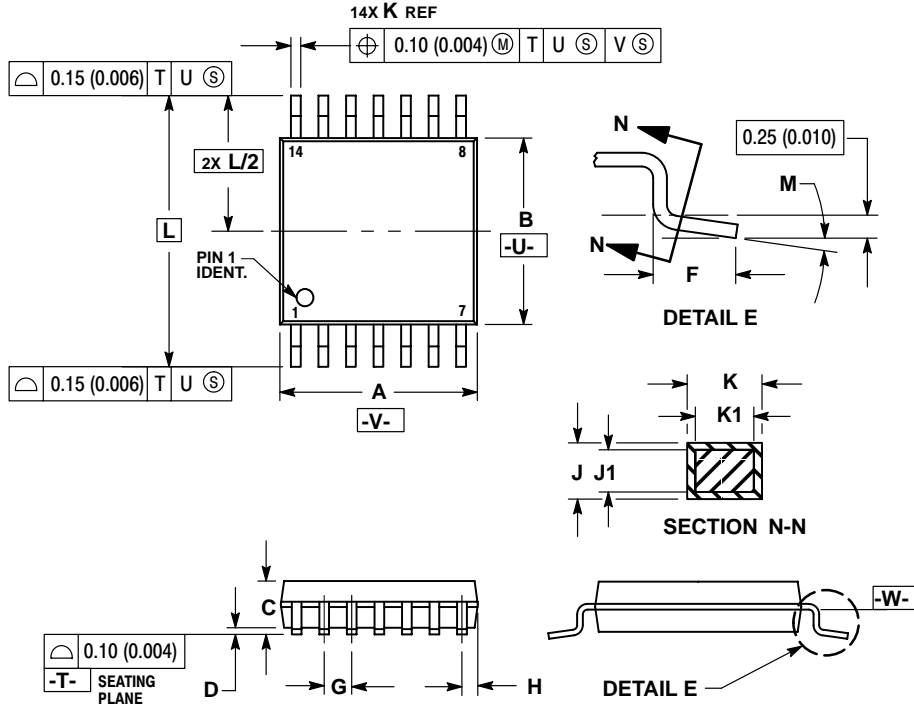

NOTES:

1. DIMENSIONING AND TOLERANCING PER ANSI Y14.5M, 1982.
2. CONTROLLING DIMENSION: MILLIMETER.
3. DIMENSION A DOES NOT INCLUDE MOLD FLASH, PROTRUSIONS OR GATE BURRS. MOLD FLASH OR GATE BURRS SHALL NOT EXCEED 0.15 (0.006) PER SIDE.
4. DIMENSION B DOES NOT INCLUDE INTERLEAD FLASH OR PROTRUSION. INTERLEAD FLASH OR PROTRUSION SHALL NOT EXCEED 0.25 (0.010) PER SIDE.
5. DIMENSION K DOES NOT INCLUDE DAMBAR PROTRUSION. ALLOWABLE DAMBAR PROTRUSION SHALL BE 0.08 (0.003) TOTAL IN EXCESS OF THE K DIMENSION AT MAXIMUM MATERIAL CONDITION.
6. TERMINAL NUMBERS ARE SHOWN FOR REFERENCE ONLY.
7. DIMENSION A AND B ARE TO BE DETERMINED AT DATUM PLANE -V-.

DIM	MILLIMETERS		INCHES	
	MIN	MAX	MIN	MAX
A	4.90	5.10	0.193	0.200
B	4.30	4.50	0.169	0.177
C	---	1.20	---	0.047
D	0.05	0.15	0.002	0.006
F	0.50	0.75	0.020	0.030
G	0.65 BSC		0.026 BSC	
H	0.50	0.60	0.020	0.024
J	0.09	0.20	0.004	0.008
J1	0.09	0.16	0.004	0.006
K	0.19	0.30	0.007	0.012
K1	0.19	0.25	0.007	0.010
L	6.40 BSC		0.252 BSC	
M	0°		8°	

SO EIAJ-14
F SUFFIX
CASE 965-01
ISSUE O

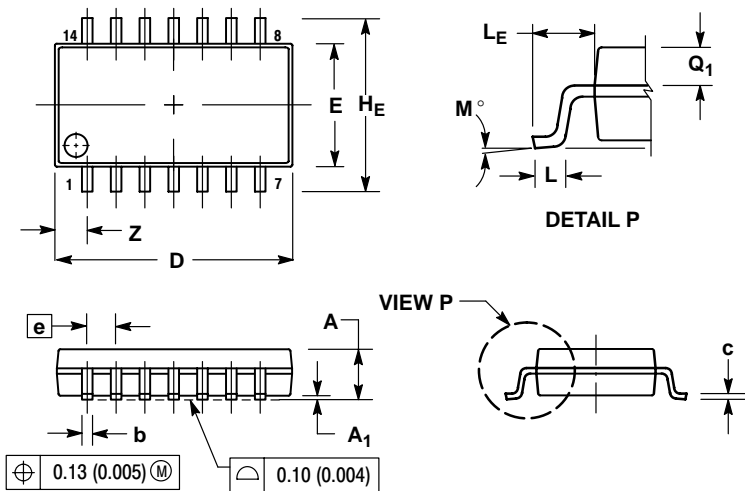

NOTES:

1. DIMENSIONING AND TOLERANCING PER ANSI Y14.5M, 1982.
2. CONTROLLING DIMENSION: MILLIMETER.
3. DIMENSIONS D AND E DO NOT INCLUDE MOLD FLASH OR PROTRUSIONS AND ARE MEASURED AT THE PARTING LINE. MOLD FLASH OR PROTRUSIONS SHALL NOT EXCEED 0.15 (0.006) PER SIDE.
4. TERMINAL NUMBERS ARE SHOWN FOR REFERENCE ONLY.
5. THE LEAD WIDTH DIMENSION (b) DOES NOT INCLUDE DAMBAR PROTRUSION. ALLOWABLE DAMBAR PROTRUSION SHALL BE 0.08 (0.003) TOTAL IN EXCESS OF THE LEAD WIDTH DIMENSION AT MAXIMUM MATERIAL CONDITION. DAMBAR CANNOT BE LOCATED ON THE LOWER RADIUS OR THE FOOT. MINIMUM SPACE BETWEEN PROTRUSIONS AND ADJACENT LEAD TO BE 0.46 (0.018).

DIM	MILLIMETERS		INCHES	
	MIN	MAX	MIN	MAX
A	---	2.05	---	0.081
A1	0.05	0.20	0.002	0.008
b	0.35	0.50	0.014	0.020
c	0.18	0.27	0.007	0.011
D	9.90	10.50	0.390	0.413
E	5.10	5.45	0.201	0.215
e	1.27 BSC		0.050 BSC	
HE	7.40	8.20	0.291	0.323
0.50	0.50	0.85	0.020	0.033
LE	1.10	1.50	0.043	0.059
M	0°		10°	
Q1	0.70	0.90	0.028	0.035
Z	---	1.42	---	0.056

MC74HCT14A

ON Semiconductor and  are registered trademarks of Semiconductor Components Industries, LLC (SCILLC). SCILLC reserves the right to make changes without further notice to any products herein. SCILLC makes no warranty, representation or guarantee regarding the suitability of its products for any particular purpose, nor does SCILLC assume any liability arising out of the application or use of any product or circuit, and specifically disclaims any and all liability, including without limitation special, consequential or incidental damages. "Typical" parameters which may be provided in SCILLC data sheets and/or specifications can and do vary in different applications and actual performance may vary over time. All operating parameters, including "Typicals" must be validated for each customer application by customer's technical experts. SCILLC does not convey any license under its patent rights nor the rights of others. SCILLC products are not designed, intended, or authorized for use as components in systems intended for surgical implant into the body, or other applications intended to support or sustain life, or for any other application in which the failure of the SCILLC product could create a situation where personal injury or death may occur. Should Buyer purchase or use SCILLC products for any such unintended or unauthorized application, Buyer shall indemnify and hold SCILLC and its officers, employees, subsidiaries, affiliates, and distributors harmless against all claims, costs, damages, and expenses, and reasonable attorney fees arising out of, directly or indirectly, any claim of personal injury or death associated with such unintended or unauthorized use, even if such claim alleges that SCILLC was negligent regarding the design or manufacture of the part. SCILLC is an Equal Opportunity/Affirmative Action Employer.

PUBLICATION ORDERING INFORMATION

Literature Fulfillment:

Literature Distribution Center for ON Semiconductor
P.O. Box 5163, Denver, Colorado 80217 USA
Phone: 303-675-2175 or 800-344-3860 Toll Free USA/Canada
Fax: 303-675-2176 or 800-344-3867 Toll Free USA/Canada
Email: ONlit@hibbertco.com

N. American Technical Support: 800-282-9855 Toll Free USA/Canada

JAPAN: ON Semiconductor, Japan Customer Focus Center
2-9-1 Kamimeguro, Meguro-ku, Tokyo, Japan 153-0051
Phone: 81-3-5773-3850

ON Semiconductor Website: <http://onsemi.com>

For additional information, please contact your local
Sales Representative.