

Memory Module Temperature Sensor w/ EEPROM for SPD

Features

- Meets JEDEC Specification
 - MCP9843 - JC42.4-TSE3000B3 Temperature Sensor
 - MCP98243 --> JC42.4-TSE2002B3 Temperature Sensor with 2 Kbit Serial EEPROM for Serial Presence Detect (SPD)
- 2-wire I²C™/SMBus Interface
- Available Packages:
 - DFN-8, TDFN-8, UDFN-8, TSSOP-8

Temperature Sensor Features

- Temperature-to-Digital Converter
- Sensor Accuracy (Grade B):
 - $\pm 0.2^{\circ}\text{C}/\pm 1^{\circ}\text{C}$ (typ./max.) $\rightarrow +75^{\circ}\text{C}$ to $+95^{\circ}\text{C}$
 - $\pm 0.5^{\circ}\text{C}/\pm 2^{\circ}\text{C}$ (typ./max.) $\rightarrow +40^{\circ}\text{C}$ to $+125^{\circ}\text{C}$
 - $\pm 1^{\circ}\text{C}/\pm 3^{\circ}\text{C}$ (typ./max.) $\rightarrow -20^{\circ}\text{C}$ to $+125^{\circ}\text{C}$
- Specified V_{DD} Range: 3.0V to 3.6V
- Operating Current: 200 μA (typical)
- Operating V_{DD} Range: 2.7V to 5.5V

Serial EEPROM Features (MCP98243)

- Specified V_{DD} Range: 1.8V to 5.5V
- Operating Current:
 - Write \rightarrow 1.1 mA (typical) for 3.5 ms (typical)
 - Read \rightarrow 100 μA (typical)
- Permanent and Reversible Software Write Protect
- Software Write Protection for the lower 1 Kbit
- Organized as 1 block of 256 x 8-bit (2 Kbit)

Typical Applications

- DIMM Modules for Servers, PCs, and Laptops
- General Purpose Temperature Datalog



Description

Microchip Technology Inc.'s MCP9843/98243 digital temperature sensors convert temperature from -40°C and $+125^{\circ}\text{C}$ to a digital word. These sensors meet JEDEC Specification JC42.4-TSE3000B3 and JC42.4-TSE2002B3 Memory Module Thermal Sensor Component. It provides an accuracy of $\pm 0.2^{\circ}\text{C}/\pm 1^{\circ}\text{C}$ (typical/maximum) from $+75^{\circ}\text{C}$ to $+95^{\circ}\text{C}$. In addition, MCP98243 has an internal 256 Byte EEPROM which can be used to store memory module and vendor information.

The MCP9843/98243 digital temperature sensor comes with user-programmable registers that provide flexibility for DIMM temperature-sensing applications. The registers allow user-selectable settings such as Shutdown or Low-Power modes and the specification of temperature Event boundaries. When the temperature changes beyond the specified Event boundary limits, the MCP9843/98243 outputs an Alert signal at the Event pin. The user has the option of setting the temperature Event output signal polarity as either an active-low or active-high comparator output for thermostat operation, or as a temperature Event interrupt output for microprocessor-based systems.

The MCP98243 EEPROM is designed specifically for DRAM DIMMs (Dual In-line Memory Modules) Serial Presence Detect (SPD). The lower 128 Bytes (address 0x00 to 0x7F) can be Permanent Write Protected (PWP) or Software Reversible Write Protected (SWP). This allows DRAM vendor and product information to be stored and write protected. The upper 128 bytes (address 0x80 to 0xFF) can be used for general purpose data storage. These addresses are not write protected.

This sensor has an industry standard 2-wire, I²C compatible serial interface, allowing up to eight devices to be controlled in a single serial bus.

Package Types

8-Pin 2x3 DFN/TDFN/UDFN *				8-Pin TSSOP			
A0	1	8	V _{DD}	A0	1	8	V _{DD}
A1	2	7	Event	A1	2	7	Event
A2	3	6	SCL	A2	3	6	SCL
GND	4	5	SDA	GND	4	5	SDA

* Includes Exposed Thermal Pad (EP); see Table 3-1.

MCP9843/98243

Sensor Typical Accuracy Performance

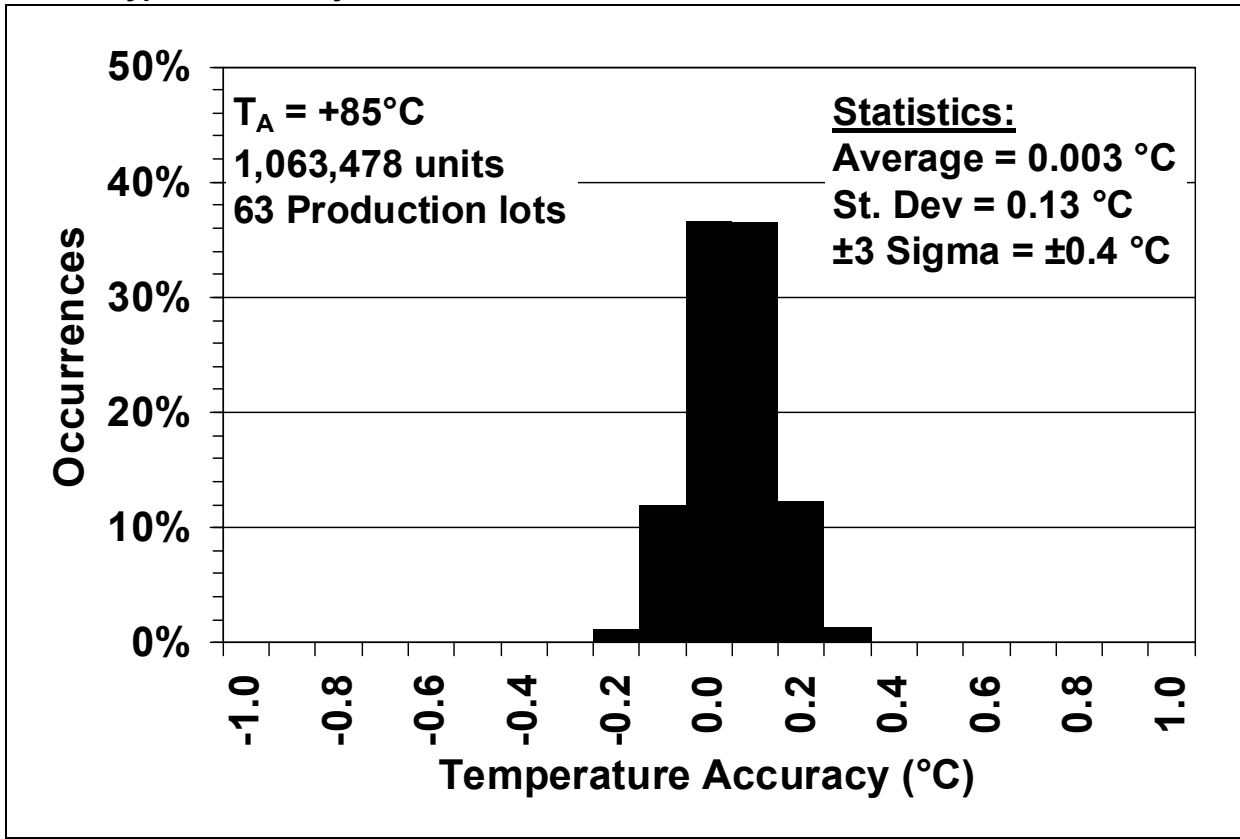

Note: This accuracy data from the production system represents the typical accuracy performance of the MCP98242 Memory Module Temperature Sensor. The MCP98242 production methodology is also used for the MCP9843/98243 to achieve the same typical accuracy performance.

MCP98243 VS. MCP98242

Feature	MCP98243	MCP98242
Event Output in Shutdown Mode	Event Output De-asserts	Event Output Remains in previous state. If the output asserts before shutdown command, it remains asserted during shutdown
I ² C communication Timeout Range	t _{OUT} = 25 ms to 35 ms	t _{OUT} = 20 ms to 50 ms
I ² C Maximum Bus Frequency	400 kHz	100 kHz
I ² C SCL & SDA V _{IL} /V _{IH} voltage levels	V _{IL_MAX} =0.3*V _{DD} , V _{IH_MIN} =0.7*V _{DD}	V _{IL_MAX} = 0.8V, V _{IH_MIN} = 2.1V
V _{HV A0} range	7V to 12V	8V to 12V
I ² C Spike Supression	50 ns	—
I ² C input hysteresis	0.05V _{DD}	0.5V
Device/Revision ID Register	0x2101 (hex)	0x2001

1.0 ELECTRICAL CHARACTERISTICS

Absolute Maximum Ratings †

V _{DD}	6.0V
Voltage at all Input/Output pins	GND – 0.3V to 6.0V
Pin A0	GND – 0.3V to 12.5V
Storage temperature	-65°C to +150°C
Ambient temp. with power applied	-40°C to +125°C
Junction Temperature (T _J)	+150°C
ESD protection on all pins (HBM:MM)	(4 kV:300V)
Latch-Up Current at each pin (25°C)	±200 mA

†**Notice:** Stresses above those listed under “Maximum ratings” may cause permanent damage to the device. This is a stress rating only and functional operation of the device at those or any other conditions above those indicated in the operational listings of this specification is not implied. Exposure to maximum rating conditions for extended periods may affect device reliability.

TEMPERATURE SENSOR DC CHARACTERISTICS

Electrical Specifications: Unless otherwise indicated, V _{DD} = 3.0V to 3.6V, GND = Ground, and T _A = -20°C to +125°C.						
Parameters	Sym	Min	Typ	Max	Unit	Conditions
Temperature Sensor Accuracy						
+75°C < T _A ≤ +95°C	T _{ACY}	-1.0	±0.2	+1.0	°C	JC42.4 - TSE2002B3 Grade B Accuracy Specification
+40°C < T _A ≤ +125°C		-2.0	±0.5	+2.0	°C	
-20°C < T _A ≤ +125°C		-3.0	±1	+3.0	°C	
T _A = -40°C		—	-1	—	°C	
Temperature Conversion Time						
0.25°C/bit	t _{CONV}	—	65	125	ms	15 s/sec (typical) (See Section 5.2.4)
Power Supply						
Specified Voltage Range	V _{DD}	3.0	—	3.6	V	JC42.4 Specified Voltage Range
Operating Voltage Range	V _{DD}	2.7	—	5.5	V	Note 1
Operating Current	I _{DD_TS}	—	200	500	µA	EEPROM Inactive
Shutdown Current - MCP9843 MCP98243	I _{SHDN}	—	1	2	µA	EEPROM Inactive, I ² C Bus Inactive
		—	1	3	µA	
Power On Reset (POR)	V _{POR_TS}	—	2.2	—	V	Threshold for falling V _{DD} voltage
Power Supply Rejection, T _A = +25°C	Δ°C/ΔV _{DD}	—	±0.3	—	°C/V	V _{DD} = 2.7V to 5.5V
		—	±0.15	—	°C	V _{DD} = 3.3V+150 mV _{PP AC} (0 to 1 MHz)
Event Output (Open-Drain output, external pull-up or pull-down resistor required), see Section 5.2.3						
High-level Current (leakage)	I _{OH}	—	—	1	µA	V _{OH} = V _{DD} (Active-Low, Pull-up Resistor)
Low-level Voltage	V _{OL}	—	—	0.4	V	I _{OL} = 3 mA (Active-Low, Pull-up Resistor)
Low-level Current (leakage)	I _{OL}	—	—	1	µA	V _{OL} = V _{SS} (Active-High, Pull-down Resistor)
High-level Voltage	V _{OH}	—	—	V _{DD} -0.5	V	I _{OH} = 3 mA (Active-High, Pull-down Resistor)
Thermal Response, from +25°C (Air) to +125°C (oil bath)						
DFN/UDFN/TDFN-8	t _{RES}	—	0.7	—	s	Time to 63% (89°C)
TSSOP-8		—	1.4	—	s	

Note 1: Characterized but not production tested. Also, see **Section 2.0 “Typical Performance Curves”**.

MCP9843/98243

MCP98243 EEPROM DC CHARACTERISTICS

Electrical Specifications: Unless otherwise indicated, $V_{DD} = 1.8V$ to $5.5V$, GND = Ground, and $T_A = -20^{\circ}C$ to $+125^{\circ}C$.

Parameters	Sym	Min	Typ	Max	Unit	Conditions
Power Supply						
Operating Voltage Range	V_{DD}	1.8	—	5.5	V	
Current, EEPROM write	I_{DD_EE}	—	1100	2000	μA	Sensor in Shutdown Mode (for t_{WC}), (Note 1)
Current, EEPROM read	I_{DD_EE}	—	100	500	μA	Sensor in Shutdown Mode (Note 1)
Power On Reset (POR)	V_{POR_EE}	—	1.6	—	V	EEPROM
Write Cycle time (byte/page)	t_{WC}	—	3	5	ms	
Endurance $T_A = +25^{\circ}C$	—	—	1M	—	cycles	Number of Write Cycles, $V_{DD} = 5V$ (Note 2)
EEPROM Write Temperature	EE_{WRITE}	0	—	85	$^{\circ}C$	
EEPROM Read Temperature	EE_{READ}	-40	—	125	$^{\circ}C$	For minimum read temperature, see Note 2
Write Protect Voltage						
SWP and CWP Voltage	V_{HV}	7	—	12	V	Applied at A0 pin (Note 3)
PWP Voltage		—	V_{DD}	—	V	

- Note 1:** For V_{DD} ranges of 1.8V to the temperature sensor V_{POR_TS} , the temperature sensor becomes partially biased and consumes 80 μA (typical) until the sensor POR resets and acknowledges a shutdown command. See [Figure 2-15](#).
- Note 2:** Characterized but not production tested. For endurance estimates in a specific application, please consult the Total Endurance™ Model which can be obtained from Microchip's web site at www.microchip.com.
- Note 3:** The range of voltage applied at A0 pin for Permanent Write Protect is GND to $V_{DD} + 1V$. See [Figure 2-13](#) and [Section 5.3.3 "Write Protection"](#).

INPUT/OUTPUT PIN DC CHARACTERISTICS (NOTE 1)

Electrical Specifications: Unless otherwise indicated, $V_{DD} = 1.8V$ to $5.5V$, GND = Ground and $T_A = -20^{\circ}C$ to $+125^{\circ}C$.

Parameters	Sym	Min	Typ	Max	Units	Conditions
Serial Input/Output (SCL, SDA, A0, A1, A2) (Note 2)						
Input						
High-level Voltage	V_{IH}	$0.7V_{DD}$	—	—	V	
Low-level Voltage	V_{IL}	—	—	$0.3V_{DD}$	V	
Input Current	I_{IN}	—	—	± 5	μA	SDA and SCL only
Input Impedance (A0, A1, A2)	Z_{IN}	—	1	—	$M\Omega$	$V_{IN} > V_{IH}$
Input Impedance (A0, A1, A2)	Z_{IN}	—	200	—	$k\Omega$	$V_{IN} < V_{IL}$
Output (SDA only)						
Low-level Voltage	V_{OL}	—	—	0.4	V	$I_{OL} = 3\text{ mA}$
High-level Current (leakage)	I_{OH}	—	—	1	μA	$V_{OH} = V_{DD}$
Low-level Current	I_{OL}	6	—	—	mA	$V_{OL} = 0.6V$
Capacitance	C_{IN}	—	5	—	pF	
SDA and SCL Inputs						
Hysteresis	V_{HYST}	—	$0.05V_{DD}$	—	V	$V_{DD} > 2V$
		—	$0.1V_{DD}$	—	V	$V_{DD} < 2V$
Spike Suppression	T_{SP}	—	—	50	ns	

- Note 1:** These specifications apply for the Temperature Sensor and EEPROM.
- Note 2:** For V_{DD} ranges of 1.8V to the temperature sensor V_{POR_TS} , the temperature sensor becomes partially biased and consumes 80 μA (typical) until the sensor POR resets and acknowledges a shutdown command. See [Figure 2-15](#).

SENSOR AND EEPROM SERIAL INTERFACE TIMING SPECIFICATIONS

Electrical Specifications: Unless otherwise indicated, GND = Ground, $T_A = -20^{\circ}\text{C}$ to $+125^{\circ}\text{C}$, and $C_L = 80\text{ pF}$ (Note 1, 5).

		$V_{DD} = 1.8\text{V to }5.5\text{V}$		$V_{DD} = 2.2\text{V to }5.5\text{V}$			
Parameters	Sym	Min	Max	Min	Max	Units	Conditions
2-Wire I²C Interface							
Serial port frequency	f_{SCL}	10	100	10	400	kHz	Note 2, 4
Low Clock	t_{LOW}	4700	—	1300	—	ns	Note 2
High Clock	t_{HIGH}	4000	—	600	—	ns	Note 2
Rise time	t_R	—	1000	20	300	ns	
Fall time	t_F	20	300	20	300	ns	
Data in Setup time	$t_{SU:DI}$	250	—	100	—	ns	Note 3
Data in Hold time	$t_{HD:DI}$	0	—	0	—	ns	Note 6
Data out Hold time	$t_{HD:DO}$	200	900	200	900	ns	Note 4
Start Condition Setup time	$t_{SU:STA}$	4700	—	600	—	ns	
Start Condition Hold time	$t_{HD:STA}$	4000	—	600	—	ns	
Stop Condition Setup time	$t_{SU:STO}$	4000	—	600	—	ns	
Bus idle	$t_{B:FREE}$	4700	—	1300	—	ns	
Time out (Sensor Only)	t_{OUT}	—	—	25	35	ms	$V_{DD} = 3.0\text{V to }3.6\text{V}$
Bus Capacitive load	C_b	—	—	—	400	pf	

Note 1: All values referred to $V_{IL\text{ MAX}}$ and $V_{IH\text{ MIN}}$ levels.

- 2:** If $t_{LOW} > t_{OUT}$ or $t_{HIGH} > t_{OUT}$, the temperature sensor I²C interface will time out. A Repeat Start command is required for communication.
- 3:** This device can be used in a Standard-mode I²C-bus system, but the requirement $t_{SU:DAT} \geq 250\text{ ns}$ must be met. This device does not stretch SCL Low time. It outputs the next data bit to the SDA line within $t_R\text{ MAX} + t_{SU:DI\text{ MIN}} = 1000\text{ ns} + 250\text{ ns} = 1250\text{ ns}$ (according to the Standard-mode I²C-bus specification) before the SCL line is released.
- 4:** As a transmitter, the device provides internal minimum delay time $t_{HD:DAT\text{ MIN}}$ to bridge the undefined region (min. 300 ns) of the falling edge of SCL $t_F\text{ MAX}$ to avoid unintended generation of Start or Stop conditions.
- 5:** For V_{DD} ranges of 1.8V to the temperature sensor $V_{POR\text{ TS}}$, the temperature sensor becomes partially biased and consumes 100 μA (typical) until the sensor POR resets and acknowledges a shutdown command.
- 6:** As a receiver, SDA should not be sampled at the falling edge of SCL. SDA can transition $t_{HD:DI}$ 0 ns after SCL toggles Low.

MCP9843/98243

TEMPERATURE CHARACTERISTICS

Electrical Specifications: Unless otherwise indicated, $V_{DD} = 1.8V$ to $5.5V$ for the EEPROM, $V_{DD} = 3.0V$ to $3.6V$ for the Temperature Sensor, and GND = Ground.

Parameters	Sym	Min	Typ	Max	Units	Conditions
Temperature Ranges						
Specified Temperature Range	T_A	-20	—	+125	°C	Note 1
Operating Temperature Range	T_A	-40	—	+125	°C	
Storage Temperature Range	T_A	-65	—	+150	°C	
Thermal Package Resistances						
Thermal Resistance, 8L-DFN	θ_{JA}	—	68	—	°C/W	
Thermal Resistance, 8L-TDFN	θ_{JA}	—	52.5	—	°C/W	
Thermal Resistance, 8L-TSSOP	θ_{JA}	—	139	—	°C/W	
Thermal Resistance, 8L-UDFN	θ_{JA}	—	41	—	°C/W	

Note 1: Operation in this range must not cause T_J to exceed Maximum Junction Temperature (+150°C).

TIMING DIAGRAM



GRAPHICAL SYMBOL DESCRIPTION



2.0 TYPICAL PERFORMANCE CURVES

Note: The graphs and tables provided following this note are a statistical summary based on a limited number of samples and are provided for informational purposes only. The performance characteristics listed herein are not tested or guaranteed. In some graphs or tables, the data presented may be outside the specified operating range (e.g., outside specified power supply range) and therefore outside the warranted range.

Note: Unless otherwise indicated, $V_{DD} = 2.7V$ to $5.5V$, GND = Ground, SDA/SCL pulled-up to V_{DD} , and $T_A = -40^{\circ}C$ to $+125^{\circ}C$.

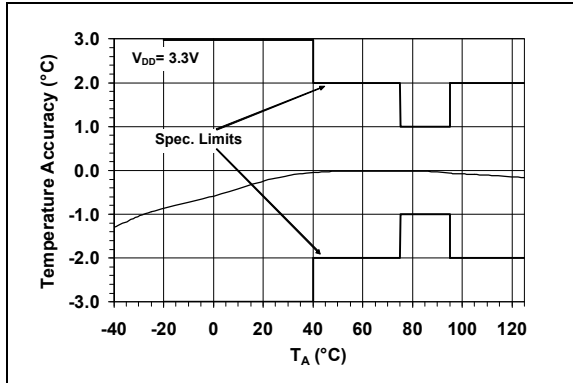

FIGURE 2-1: Average Temperature Accuracy.



FIGURE 2-4: Supply Current vs. Temperature.

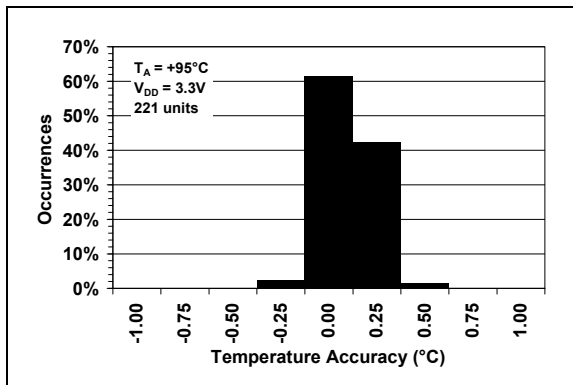

FIGURE 2-2: Temperature Accuracy Histogram, $T_A = +95^{\circ}C$.



FIGURE 2-5: Serial Bus Time-Out vs. Temperature.

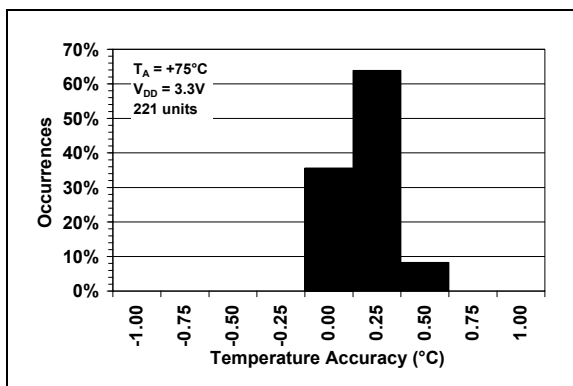

FIGURE 2-3: Temperature Accuracy Histogram, $T_A = +75^{\circ}C$.

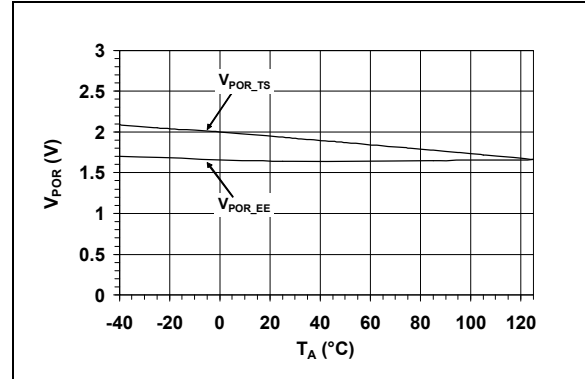

FIGURE 2-6: Power-on Reset Threshold Voltage vs. Temperature.

MCP9843/98243

Note: Unless otherwise indicated, $V_{DD} = 2.7V$ to $5.5V$, GND = Ground, SDA/SCL pulled-up to V_{DD} , and $T_A = -40^{\circ}C$ to $+125^{\circ}C$.



FIGURE 2-7: Event and SDA V_{OL} vs. Temperature.



FIGURE 2-10: SDA I_{OL} vs. Temperature.



FIGURE 2-8: Conversion Rate vs. Temperature.



FIGURE 2-11: Temperature Accuracy vs. V_{DD} .



FIGURE 2-9: Power Supply Rejection vs. Frequency.



FIGURE 2-12: Package Thermal Response.

Note: Unless otherwise indicated, $V_{DD} = 2.7V$ to $5.5V$, GND = Ground, SDA/SCL pulled-up to V_{DD} , and $T_A = -40^\circ C$ to $+125^\circ C$.



FIGURE 2-13: SWP/CWP/PWP High Voltage Range.



FIGURE 2-15: Shutdown Current vs. V_{DD} .

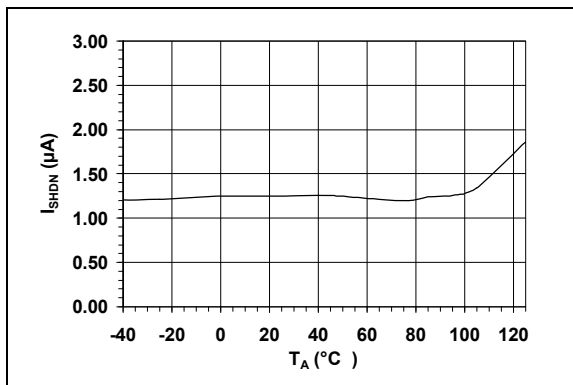

FIGURE 2-14: Shutdown Current vs. Temperature.

MCP9843/98243

NOTES:

3.0 PIN DESCRIPTION

The descriptions of the pins are listed in [Table 3-1](#).

TABLE 3-1: PIN FUNCTION TABLES

MCP9843/98243		Symbol	Description
DFN, TDFN, UDFN	TSSOP		
1	1	A0	Slave Address and EEPROM Software Write Protect high voltage input (V_{HV})
2	2	A1	Slave Address
3	3	A2	Slave Address
4	4	GND	Ground
5	5	SDA	Serial Data Line
6	6	SCL	Serial Clock Line
7	7	Event	Temperature Alert Output
8	8	V_{DD}	Power Pin
9	—	EP	Exposed Thermal Pad (EP); can be connected to GND.

3.1 Address Pins (A0, A1, A2)

These pins are device address input pins.

The address pins correspond to the Least Significant bits (LSb) of address bits. The Most Significant bits (MSb) (A6, A5, A4, A3). This is shown in [Table 3-2](#).

TABLE 3-2: MCP9843/98243 ADDRESS BYTE

Device	Address Code				Slave Address		
	A6	A5	A4	A3	A2	A1	A0
Sensor	0	0	1	1			
EEPROM	1	0	1	0	X	X	X
EEPROM Write Protect	0	1	1	0			

Note: User-selectable address is shown by X.

The A0 Address pin is a multi-function pin. This input pin is also used for high voltage input V_{HV} to enable the EEPROM Software Write Protect feature, see [Section 5.3.3 “Write Protection”](#).

All address pin have an internal pull-down resistors.

3.2 Ground Pin (GND)

The GND pin is the system ground pin.

3.3 Serial Data Line (SDA)

SDA is a bidirectional input/output pin, used to serially transmit data to/from the host controller. This pin requires a pull-up resistor. (See [Section 4.0 “Serial Communication”](#)).

3.4 Serial Clock Line (SCL)

The SCL is a clock input pin. All communication and timing is relative to the signal on this pin. The clock is generated by the host or master controller on the bus. (See [Section 4.0 “Serial Communication”](#)).

3.5 Temperature Alert, Open-Drain Output (Event)

The MCP9843/98243 temperature Event output pin is an open-drain output. The device outputs a signal when the ambient temperature goes beyond the user-programmed temperature limit. (see [Section 5.2.3 “Event Output Configuration”](#)).

3.6 Power Pin (V_{DD})

V_{DD} is the power pin. The operating voltage range, as specified in the DC electrical specification table, is applied on this pin.

3.7 Exposed Thermal Pad (EP)

There is an internal electrical connection between the Exposed Thermal Pad (EP) and the GND pin; they can be connected to the same potential on the Printed Circuit Board (PCB). This provides better thermal conduction from the PCB to the die.

MCP9843/98243

NOTES:

4.0 SERIAL COMMUNICATION

4.1 2-Wire Standard Mode I²C™ Protocol-Compatible Interface

The MCP9843/98243 serial clock input (SCL) and the bidirectional serial data line (SDA) form a 2-wire bidirectional Standard mode I²C compatible communication port (refer to the **Input/Output Pin DC Characteristics (Note 1)** Table and **Sensor And EEPROM Serial Interface Timing Specifications** Table).

The following bus protocol has been defined:

TABLE 4-1: MCP9843/98243 SERIAL BUS PROTOCOL DESCRIPTIONS

Term	Description
Master	The device that controls the serial bus, typically a microcontroller.
Slave	The device addressed by the master, such as the MCP9843/98243.
Transmitter	Device sending data to the bus.
Receiver	Device receiving data from the bus.
START	A unique signal from master to initiate serial interface with a slave.
STOP	A unique signal from the master to terminate serial interface from a slave.
Read/Write	A read or write to the MCP9843/98243 registers.
ACK	A receiver Acknowledges (ACK) the reception of each byte by polling the bus.
NAK	A receiver Not-Acknowledges (NAK) or releases the bus to show End-of-Data (EOD).
Busy	Communication is not possible because the bus is in use.
Not Busy	The bus is in the idle state, both SDA and SCL remain high.
Data Valid	SDA must remain stable before SCL becomes high in order for a data bit to be considered valid. During normal data transfers, SDA only changes state while SCL is low.

4.1.1 DATA TRANSFER

Data transfers are initiated by a Start condition (START), followed by a 7-bit device address and a read/write bit. An Acknowledge (ACK) from the slave confirms the reception of each byte. Each access must be terminated by a Stop condition (STOP).

Repeated communication is initiated after t_{B-FREE} .

This device does not support sequential register read/write. Each register needs to be addressed using the Register Pointer.

This device supports the Receive Protocol. The register can be specified using the pointer for the initial read. Each repeated read or receive begins with a Start condition and address byte. The MCP9843/98243 retain the previously selected register. Therefore, they output data from the previously-specified register (repeated pointer specification is not necessary).

4.1.2 MASTER/SLAVE

The bus is controlled by a master device (typically a microcontroller) that controls the bus access and generates the Start and Stop conditions. The MCP9843/98243 is a slave device and does not control other devices in the bus. Both master and slave devices can operate as either transmitter or receiver. However, the master device determines which mode is activated.

4.1.3 START/STOP CONDITION

A high-to-low transition of the SDA line (while SCL is high) is the Start condition. All data transfers must be preceded by a Start condition from the master. A low-to-high transition of the SDA line (while SCL is high) signifies a Stop condition.

If a Start or Stop condition is introduced during data transmission, the MCP9843/98243 releases the bus. All data transfers are ended by a Stop condition from the master.

4.1.4 ADDRESS BYTE

Following the Start condition, the host must transmit an 8-bit address byte to the MCP9843/98243. The address for the MCP9843/98243 Temperature Sensor is '0011, A2, A1, A0' in binary, where the A2, A1 and A0 bits are set externally by connecting the corresponding pins to V_{DD} '1' or GND '0'. The 7-bit address transmitted in the serial bit stream must match the selected address for the MCP9843/98243 to respond with an ACK. Bit 8 in the address byte is a read/write bit. Setting this bit to '1' commands a read operation, while '0' commands a write operation (see Figure 4-1).



FIGURE 4-1: Device Addressing.

MCP9843/98243

4.1.5 DATA VALID

After the Start condition, each bit of data in transmission needs to be settled for a time specified by $t_{SU-DATA}$ before SCL toggles from low-to-high (see **“Sensor And EEPROM Serial Interface Timing Specifications” on Page 5**).

4.1.6 ACKNOWLEDGE (ACK/NAK)

Each receiving device, when addressed, is obliged to generate an ACK bit after the reception of each byte. The master device must generate an extra clock pulse for ACK to be recognized.

The acknowledging device pulls down the SDA line for $t_{SU-DATA}$ before the low-to-high transition of SCL from the master. SDA also needs to remain pulled down for t_{H-DATA} after a high-to-low transition of SCL.

During read, the master must signal an End-of-Data (EOD) to the slave by not generating an ACK bit (NAK) once the last bit has been clocked out of the slave. In this case, the slave will leave the data line released to enable the master to generate the Stop condition.

4.1.7 TIME OUT (MCP9843/98243, SENSOR ONLY)

If the SCL stays low or high for time specified by t_{OUT} , the MCP9843/98243 temperature sensor resets the serial interface. This dictates the minimum clock speed as specified in the specification. However, the EEPROM does not reset the serial interface. Therefore, the master can hold the clock indefinitely to process data from the EEPROM.

5.0 FUNCTIONAL DESCRIPTION

The MCP9843/98243 temperature sensors consists of a band-gap type temperature sensor, a Delta-Sigma Analog-to-Digital Converter ($\Sigma\Delta$ ADC), user-program-

mable registers and a 2-wire I²C protocol compatible serial interface. Figure 5-1 shows a block diagram of the register structure.



FIGURE 5-1: Functional Block Diagram.

MCP9843/98243

5.1 Registers

The MCP9843/98243 device has several registers that are user-accessible. These registers include the Capability register, Configuration register, Event Temperature Upper-Boundary and Lower-Boundary Trip registers, Critical Temperature Trip register, Temperature register, Manufacturer Identification register and Device Identification register.

The Temperature register is read-only, used to access the ambient temperature data. The data is loaded in parallel to this register after t_{CONV} . The Event Temperature Upper-Boundary and Lower-Boundary Trip registers are read/writes. If the ambient temperature drifts beyond the user-specified limits, the MCP9843/98243 device outputs a signal using the Event pin (refer to **Section 5.2.3 “Event Output Configuration”**). In addition, the Critical Temperature Trip register is used to provide an additional critical temperature limit.

The Capability register is used to provide bits describing the MCP9843/98243’s capability in measurement resolution, measurement range and device accuracy. The device Configuration register provides access to configure the MCP9843/98243’s various features. These registers are described in further detail in the following sections.

The registers are accessed by sending a Register Pointer to the MCP9843/98243 using the serial interface. This is an 8-bit write-only pointer. However, the four Least Significant bits are used as pointers and all unused bits (bits 7-4) need to be cleared or set to ‘0’. [Register 5-1](#) describes the pointer or the address of each register.

REGISTER 5-1: REGISTER POINTER (WRITE ONLY)

W-0	W-0	W-0	W-0	W-0	W-0	W-0	W-0
—	—	—	—	Pointer Bits			
bit 7							bit 0

Legend:			
R = Readable bit	W = Writable bit	U = Unimplemented bit, read as ‘0’	
-n = Value at POR	‘1’ = Bit is set	‘0’ = Bit is cleared	x = Bit is unknown

- bit 7-4 **Writable Bits:** Write ‘0’
- bit 3-0 **Pointer Bits:**
 - 0000 = Capability register
 - 0001 = Configuration register (CONFIG)
 - 0010 = Event Temperature Upper-Boundary Trip register (T_{UPPER})
 - 0011 = Event Temperature Lower-Boundary Trip register (T_{LOWER})
 - 0100 = Critical Temperature Trip register (T_{CRIT})
 - 0101 = Temperature register (T_A)
 - 0110 = Manufacturer ID register
 - 0111 = Device ID/Revision register
 - 1000 = Resolution register
 - 1XXX = Reserved (This device has additional registers that are reserved for test and calibration. If these registers are accessed, the device may not perform according to the specification.)

**TABLE 5-1: BIT ASSIGNMENT SUMMARY FOR ALL TEMPERATURE SENSOR REGISTERS
(SEE SECTION 5.4)**

Register Pointer (Hex)	MSB/LSB	Bit Assignment							
		7	6	5	4	3	2	1	0
0x00	MSB	0	0	0	0	0	0	0	0
	LSB	SHDN Status	t _{OUT} Range	V _{HV}	Resolution		Range	Accuracy	Event
0x01	MSB	0	0	0	0	0	Hysteresis		SHDN
	LSB	Crt Loc	Win Loc	Int Clr	Evt Stat	Evt Cnt	Evt Sel	Evt Pol	Evt Mod
0x02	MSB	0	0	0	SIGN	2 ⁷ °C	2 ⁶ °C	2 ⁵ °C	2 ⁴ °C
	LSB	2 ³ °C	2 ² °C	2 ¹ °C	2 ⁰ °C	2 ⁻¹ °C	2 ⁻² °C	0	0
0x03	MSB	0	0	0	SIGN	2 ⁷ °C	2 ⁶ °C	2 ⁵ °C	2 ⁴ °C
	LSB	2 ³ °C	2 ² °C	2 ¹ °C	2 ⁰ °C	2 ⁻¹ °C	2 ⁻² °C	0	0
0x04	MSB	0	0	0	SIGN	2 ⁷ °C	2 ⁶ °C	2 ⁵ °C	2 ⁴ °C
	LSB	2 ³ °C	2 ² °C	2 ¹ °C	2 ⁰ °C	2 ⁻¹ °C	2 ⁻² °C	0	0
0x05	MSB	T _A ≥ T _{CRIT}	T _A > T _{UPPER}	T _A < T _{LOWER}	SIGN	2 ⁷ °C	2 ⁶ °C	2 ⁵ °C	2 ⁴ °C
	LSB	2 ³ °C	2 ² °C	2 ¹ °C	2 ⁰ °C	2 ⁻¹ °C	2 ⁻² °C	2 ⁻³ °C	2 ⁻⁴ °C
0x06	MSB	0	0	0	0	0	0	0	0
	LSB	0	1	0	1	0	1	0	0
0x07 MCP98243	MSB	0	0	1	0	0	0	0	1
	LSB	0	0	0	0	0	0	0	1
0x07 MCP9843	MSB	0	0	0	0	0	0	0	0
	LSB	0	0	0	0	0	0	0	1
0x08	LSB	0	0	0	0	0	0	0	1

MCP9843/98243

5.1.1 CAPABILITY REGISTER

This is a read-only register used to identify the temperature sensor capability. For example, the MCP9843/98243 device is capable of providing temperature at 0.25°C resolution, measuring temperature below and above 0°C, providing ±1°C and ±2°C accuracy over the active and monitor temperature ranges (respectively) and providing user-programmable temperature event boundary trip limits. [Register 5-2](#) describes the Capability register. These functions are described in further detail in the following sections.

REGISTER 5-2: CAPABILITY REGISTER (READ-ONLY) → ADDRESS '0000 0000'b

U-0	U-0	U-0	U-0	U-0	U-0	U-0	U-0
—	—	—	—	—	—	—	—
bit 15							bit 8

R-1	R-1	R-1	R-0	R-1	R-1	R-1	R-1
SHDN Status	t _{OUT} Range	V _{HV}	Resolution	Meas Range	Accuracy	Temp Alarm	
bit 7							bit 0

Legend:			
R = Readable bit	W = Writable bit	U = Unimplemented bit, read as '0'	
-n = Value at POR	'1' = Bit is set	'0' = Bit is cleared	x = Bit is unknown

bit 15-8 **Unimplemented:** Read as '0'

bit 7 **Event output status during Shutdown (SHDN Status):**
 0 = Event output remains in previous state. If the output asserts before shutdown command, it remains asserted during shutdown.
 1 = Event output de-asserts during shutdown. After shutdown, it takes t_{CONV} to re-assert the Event output (power-up default)

bit 6 **1°C Bus time-out (t_{OUT} Range):**
 0 = Bus time-out range is 10 ms to 60 ms
 1 = Bus time-out range is 25 ms to 35 ms (power-up default)

bit 5 **High Voltage Input**
 0 = Pin A0 does not accept High Voltage
 1 = Pin A0 accepts High Voltage for the EEPROM Write Protect feature (power-up default)

bit 4-3 **Resolution:**
 00 = 0.5°C
 01 = 0.25°C (power up default)
 10 = 0.125°C
 11 = 0.0625°C
 These bits reflect the selected resolution (see **Section 5.2.4 "Temperature Resolution"**)

bit 2 **Temperature Measurement Range (Meas. Range):**
 0 = T_A = 0 (decimal) for temperature below 0°C
 1 = The part can measure temperature below 0°C (power-up default)

REGISTER 5-2: CAPABILITY REGISTER (READ-ONLY) → ADDRESS '0000 0000'b (CONTINUED)

- bit 1 **Accuracy:**
- 0 = Accuracy → ±2°C from +75°C to +95°C (Active Range) and ±3°C from +40°C to +125°C (Monitor Range)
 - 1 = Accuracy → ±1°C from +75°C to +95°C (Active Range) and ±2°C from +40°C to +125°C (Monitor Range)
- bit 0 **Temperature Alarm:**
- 0 = No defined function (This bit will never be cleared or set to '0')
 - 1 = The part has temperature boundary trip limits (T_{UPPER}/T_{LOWER}/T_{CRIT} registers) and a temperature event output (JC 42.4 required feature)

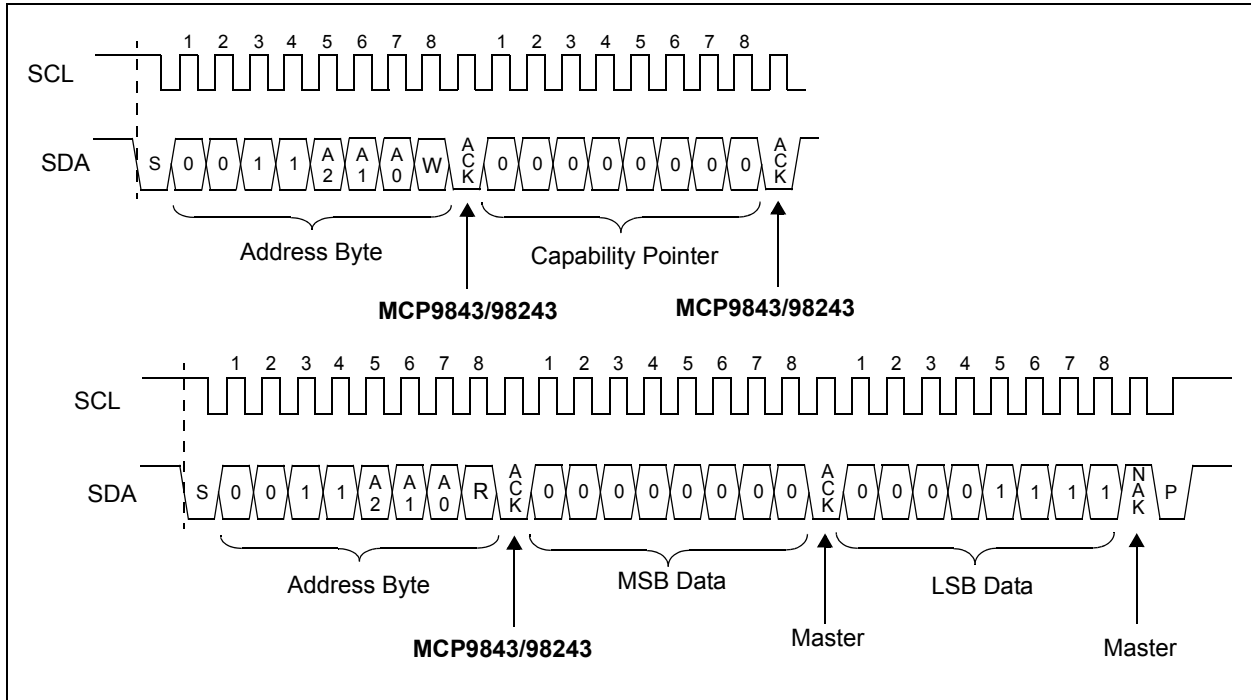

FIGURE 5-2: Timing Diagram for Reading the Capability Register (See **Section 4.0 “Serial Communication”**).

MCP9843/98243

5.1.2 SENSOR CONFIGURATION REGISTER (CONFIG)

The MCP9843/98243 device has a 16-bit Configuration register (CONFIG) that allows the user to set various functions for a robust temperature monitoring system. Bits 10 thru 0 are used to select Event output boundary hysteresis, device Shutdown or Low-Power mode, temperature boundary and critical temperature lock, temperature Event output enable/disable. In addition, the user can select the Event output condition (output set for T_{UPPER} and T_{LOWER} temperature boundary or T_{CRIT} only), read Event output status and set Event output polarity and mode (Comparator Output or Interrupt Output mode).

The temperature hysteresis bits 10 and 9 can be used to prevent output chatter when the ambient temperature gradually changes beyond the user-specified temperature boundary (see **Section 5.2.2 “Temperature Hysteresis (T_{HYST})”**). The Continuous

Conversion or Shutdown mode is selected using bit 8. In Shutdown mode, the band gap temperature sensor circuit stops converting temperature and the Ambient Temperature register (T_A) holds the previous successfully converted temperature data (see **Section 5.2.1 “Shutdown Mode”**). Bits 7 and 6 are used to lock the user-specified boundaries T_{UPPER}, T_{LOWER} and T_{CRIT} to prevent an accidental rewrite. Bits 5 thru 0 are used to configure the temperature Event output pin. All functions are described in [Register 5-3](#) (see **Section 5.2.3 “Event Output Configuration”**).

REGISTER 5-3: CONFIGURATION REGISTER (CONFIG) → ADDRESS '0000 0001'b

U-0	U-0	U-0	U-0	U-0	R/W-0	R/W-0	R/W-0
—	—	—	—	—	T _{HYST}		SHDN
bit 15							bit 8

R/W-0	R/W-0	R/W-0	R-0	R/W-0	R/W-0	R/W-0	R/W-0
Crit. Lock	Win. Lock	Int. Clear	Event Stat.	Event Cnt.	Event Sel.	Event Pol.	Event Mod.
bit 7							bit 0

Legend:			
R = Readable bit	W = Writable bit	U = Unimplemented bit, read as '0'	
-n = Value at POR	'1' = Bit is set	'0' = Bit is cleared	x = Bit is unknown

- bit 15-11 **Unimplemented:** Read as '0'
- bit 10-9 **T_{UPPER} and T_{LOWER} Limit Hysteresis (T_{HYST}):**
 - 00 = 0°C (power-up default)
 - 01 = 1.5°C
 - 10 = 3.0°C
 - 11 = 6.0°C

(Refer to **Section 5.2.3 “Event Output Configuration”**)

This bit can not be altered when either of the lock bits are set (bit 6 and bit 7).

This bit can be programmed in shutdown mode.

- bit 8 **Shutdown Mode (SHDN):**
 - 0 = Continuous Conversion (power-up default)
 - 1 = Shutdown (Low-Power mode)

In shutdown, all power-consuming activities are disabled, though all registers can be written to or read. Event output will de-assert.

This bit cannot be set '1' when either of the lock bits is set (bit 6 and bit 7). However, it can be cleared '0' for Continuous Conversion while locked (Refer to **Section 5.2.1 “Shutdown Mode”**).

REGISTER 5-3: CONFIGURATION REGISTER (CONFIG) → ADDRESS '0000 0001'b

bit 7	<p>T_{CRIT} Lock Bit (Crit. Lock): 0 = Unlocked. T_{CRIT} register can be written. (power-up default) 1 = Locked. T_{CRIT} register can not be written</p> <p>When enabled, this bit remains set '1' or locked until cleared by internal reset (Section 5.4 "Summary of Power-on Default"). This bit does not require a double-write.</p> <p>This bit can be programmed in shutdown mode.</p>
bit 6	<p>T_{UPPER} and T_{LOWER} Window Lock Bit (Win. Lock): 0 = Unlocked. T_{UPPER} and T_{LOWER} registers can be written. (power-up default) 1 = Locked. T_{UPPER} and T_{LOWER} registers can not be written</p> <p>When enabled, this bit remains set '1' or locked until cleared by power-on Respell (Section 5.4 "Summary of Power-on Default"). This bit does not require a double-write.</p> <p>This bit can be programmed in shutdown mode.</p>
bit 5	<p>Interrupt Clear (Int. Clear) Bit: 0 = No effect (power-up default) 1 = Clear interrupt output. When read this bit returns '0'</p> <p>This bit clears the Interrupt flag which de-asserts Event output. In shutdown mode, the Event output is always de-asserted. Therefore, setting this bit in shutdown mode clears the interrupt after the device returns to normal operation.</p>
bit 4	<p>Event Output Status (Event Stat.) Bit: 0 = Event output is not asserted by the device (power-up default) 1 = Event output is asserted as a comparator/Interrupt or critical temperature output</p> <p>In shutdown mode this bit will clear because Event output is always de-asserted in shutdown mode.</p>
bit 3	<p>Event Output Control (Event Cnt.) Bit: 0 = Event output Disabled (power-up default) 1 = Event output Enabled</p> <p>This bit can not be altered when either of the lock bits is set (bit 6 and bit 7).</p> <p>This bit can be programmed in shutdown mode, but Event output will remain de-asserted.</p>
bit 2	<p>Event Output Select (Event Sel.) Bit: 0 = Event output for T_{UPPER}, T_{LOWER} and T_{CRIT} (power-up default) 1 = T_A ≥ T_{CRIT} only. (T_{UPPER} and T_{LOWER} temperature boundaries are disabled.)</p> <p>When the Alarm Window Lock bit is set, this bit cannot be altered until unlocked (bit 6).</p> <p>This bit can be programmed in shutdown mode, but Event output will remain de-asserted.</p>
bit 1	<p>Event Output Polarity (Event Pol.) Bit: 0 = Active low (power-up default. Pull-up resistor required) See Section 5.2.3 "Event Output Configuration" 1 = Active-high (Pull-down resistor required) See Section 5.2.3 "Event Output Configuration"</p> <p>This bit cannot be altered when either of the lock bits is set (bit 6 and bit 7).</p> <p>This bit can be programmed in shutdown mode, but Event output will remain de-asserted.</p>
bit 0	<p>Event Output Mode (Event Mod.) Bit: 0 = Comparator output (power-up default) 1 = Interrupt output</p> <p>This bit cannot be altered when either of the lock bits is set (bit 6 and bit 7).</p> <p>This bit can be programmed in shutdown mode, but Event output will remain de-asserted.</p>

MCP9843/98243



FIGURE 5-3: Timing Diagram for Writing to the Configuration Register (See Section 4.0 “Serial Communication”).



FIGURE 5-4: Timing Diagram for Reading from the Configuration Register (See Section 4.0 “Serial Communication”).

MCP9843/98243

5.1.3 UPPER/LOWER/CRITICAL TEMPERATURE LIMIT REGISTERS ($T_{UPPER}/T_{LOWER}/T_{CRIT}$)

The MCP9843/98243 device has a 16-bit read/write Event output Temperature Upper-Boundary Trip register (T_{UPPER}), a 16-bit Lower-Boundary Trip register (T_{LOWER}) and a 16-bit Critical Boundary Trip register (T_{CRIT}) that contains 11-bit data in two's complement format (0.25°C). This data represents the maximum and minimum temperature boundary or temperature window that can be used to monitor ambient temperature. If this feature is enabled (Section 5.1.2 "Sensor Configuration Register (CONFIG)") and the ambient temperature exceeds the specified boundary or window, the MCP9843/98243 asserts an Event output. (Refer to Section 5.2.3 "Event Output Configuration").

REGISTER 5-4: UPPER/LOWER/CRITICAL TEMPERATURE LIMIT REGISTER ($T_{UPPER}/T_{LOWER}/T_{CRIT}$) → ADDRESS '0000 0010'b/'0000 0011'b/'0000 0100'b (NOTE 1)

U-0	U-0	U-0	R/W-0	R/W-0	R/W-0	R/W-0	R/W-0	
—	—	—	Sign	2^7°C	2^6°C	2^5°C	2^4°C	
bit 15								bit 8

R/W-0	R/W-0	R/W-0	R/W-0	R/W-0	R/W-0	U-0	U-0	
2^3°C	2^2°C	2^1°C	2^0°C	$2^{-1^{\circ}\text{C}}$	$2^{-2^{\circ}\text{C}}$	—	—	
bit 7								bit 0

Legend:			
R = Readable bit	W = Writable bit	U = Unimplemented bit, read as '0'	
-n = Value at POR	'1' = Bit is set	'0' = Bit is cleared	x = Bit is unknown

bit 15-13 **Unimplemented:** Read as '0'

bit 12 **Sign:**
 0 = $T_A \geq 0^{\circ}\text{C}$
 1 = $T_A < 0^{\circ}\text{C}$

bit 11-2 **$T_{UPPER}/T_{LOWER}/T_{CRIT}$:**
 Temperature boundary trip data in two's complement format.

bit 1-0 **Unimplemented:** Read as '0'

Note 1: This table shows two 16-bit registers for T_{UPPER} , T_{LOWER} and T_{CRIT} located at '0000 0010b', '0000 0011b' and '0000 0100b', respectively.



FIGURE 5-5: Timing Diagram for Writing and Reading from the T_{UPPER} Register (See **Section 4.0** “Serial Communication”).

MCP9843/98243

5.1.4 AMBIENT TEMPERATURE REGISTER (T_A)

The MCP9843/98243 device uses a band gap temperature sensor circuit to output analog voltage proportional to absolute temperature. An internal $\Delta\Sigma$ ADC is used to convert the analog voltage to a digital word. The converter resolution is set to $0.25^\circ\text{C} + \text{sign}$ (11-bit data). The digital word is loaded to a 16-bit read-only Ambient Temperature register (T_A) that contains 11-bit temperature data in two's complement format.

The T_A register bits (bits 12 thru 0) are double-buffered. Therefore, the user can access the register while, in the background, the MCP9843/98243 performs an analog-to-digital conversion. The temperature data from the $\Delta\Sigma$ ADC is loaded in parallel to the T_A register at t_{CONV} refresh rate.

In addition, the T_A register uses three bits (bits 15, 14 and 13) to reflect the Event pin state. This allows the user to identify the cause of the Event output trigger (see **Section 5.2.3 “Event Output Configuration”**); bit 15 is set to '1' if T_A is greater than or equal to T_{CRIT} , bit 14 is set to '1' if T_A is greater than T_{UPPER} and bit 13 is set to '1' if T_A is less than T_{LOWER} .

The T_A register bit assignment and boundary conditions are described in [Register 5-5](#).

REGISTER 5-5: AMBIENT TEMPERATURE REGISTER (T_A) → ADDRESS '0000 0101'b (NOTE 1)

R-0	R-0	R-0	R-0	R-0	R-0	R-0	R-0
T_A vs. T_{CRIT}	T_A vs. T_{UPPER}	T_A vs. T_{LOWER}	SIGN	2^7 °C	2^6 °C	2^5 °C	2^4 °C
bit 15							bit 8

R-0	R-0	R-0	R-0	R-0	R-0	R-0	R-0
2^3 °C	2^2 °C	2^1 °C	2^0 °C	2^{-1} °C	2^{-2} °C	2^{-3} °C	2^{-4} °C
bit 7							bit 0

Legend:			
R = Readable bit	W = Writable bit	U = Unimplemented bit, read as '0'	
-n = Value at POR	'1' = Bit is set	'0' = Bit is cleared	x = Bit is unknown

bit 15 **T_A vs. T_{CRIT} ⁽¹⁾ Bit:**

- 0 = $T_A < T_{\text{CRIT}}$
- 1 = $T_A \geq T_{\text{CRIT}}$

bit 14 **T_A vs. T_{UPPER} ⁽¹⁾ Bit:**

- 0 = $T_A \leq T_{\text{UPPER}}$
- 1 = $T_A > T_{\text{UPPER}}$

bit 13 **T_A vs. T_{LOWER} ⁽¹⁾ Bit:**

- 0 = $T_A \geq T_{\text{LOWER}}$
- 1 = $T_A < T_{\text{LOWER}}$

bit 12 **SIGN Bit:**

- 0 = $T_A \geq 0^\circ\text{C}$
- 1 = $T_A < 0^\circ\text{C}$

bit 11-0 **Ambient Temperature (T_A) Bits: (Note 2)**

12-bit Ambient Temperature data in two's complement format.

Note 1: Bits 15, 14 and 13 are not affected by the status of the Event output configuration (bits 5 to 0 of CONFIG) ([Register 5-3](#)).

2: Bits 2, 1, and 0 may remain clear '0' depending on the status of the resolution register ([Register 5-9](#)). The Power-up default is $0.25^\circ\text{C}/\text{bit}$, bits 1 and 0 remain clear '0'.

5.1.4.1 T_A bits to Temperature Conversion

To convert the T_A bits to decimal temperature, the upper three boundary bits (bits 15, 14 and 13) must be masked out. Then determine the sign bit (bit 12) to check positive or negative temperature, shift the bits accordingly and combine the upper and lower bytes of the 16-bit register. The upper byte contains data for temperatures greater than 32°C while the lower byte contains data for temperature less than 32°C, including fractional data. When combining the upper and lower bytes, the upper byte must be Right-shifted by 4bits (or multiply by 2^4) and the lower byte must be Left-shifted by 4 bits (or multiply by 2^{-4}). Adding the results of the shifted values provides the temperature data in decimal format, see [Equation 5-1](#).

The temperature bits are in two's compliment format, therefore, positive temperature data and negative temperature data are computed differently. [Equation 5-1](#) shows the temperature computation. The example instruction code outlined in [Figure 5-6](#) shows the communication flow, also see [Figure 5-7](#) for timing diagram.

EQUATION 5-1: BYTES TO TEMPERATURE CONVERSION

Temperature $\geq 0^\circ\text{C}$

$$T_A = (\text{UpperByte} \times 2^4 + \text{LowerByte} \times 2^{-4})$$

Temperature $< 0^\circ\text{C}$

$$T_A = 256 - (\text{UpperByte} \times 2^4 + \text{LowerByte} \times 2^{-4})$$

Where:

T_A = Ambient Temperature ($^\circ\text{C}$)

UpperByte = T_A bit 15 to bit 8

LowerByte = T_A bit 7 to bit 0

This example routine assumes the variables and I²C communication subroutines are predefined:

```

i2c_start(); // send START command
i2c_write(AddressByte & 0xFE); //WRITE Command
//also, make sure bit 0 is cleared '0'

i2c_write(0x05); // Write TA Register Address
i2c_start(); //Repeat START
i2c_write(AddressByte | 0x01); // READ Command
//also, make sure bit 0 is Set '1'

UpperByte = i2c_read(ACK); // READ 8 bits
//and Send ACK bit

LowerByte = i2c_read(NAK); // READ 8 bits
//and Send NAK bit

i2c_stop(); // send STOP command

//Convert the temperature data
//First Check flag bits
if ((UpperByte & 0x80) == 0x80){ //TA ≥ TCRIT
}
if ((UpperByte & 0x40) == 0x40){ //TA > TUPPER
}
if ((UpperByte & 0x20) == 0x20){ //TA < TLOWER
}
UpperByte = UpperByte & 0x1F; //Clear flag bits
if ((UpperByte & 0x10) == 0x10){ //TA < 0°C
    UpperByte = UpperByte & 0x0F; //Clear SIGN
    Temperature = 256 - (UpperByte x 16 + LowerByte / 16);
}else //TA ≥ 0°C
    Temperature = (UpperByte x 16 + LowerByte / 16);
//Temperature = Ambient Temperature (°C)
    
```

FIGURE 5-6: Example Instruction Code.

MCP9843/98243



FIGURE 5-7: Timing Diagram for Reading +25.25°C Temperature from the T_A Register (See Section 4.0 “Serial Communication”).

5.1.5 MANUFACTURER ID REGISTER

This register is used to identify the manufacturer of the device in order to perform manufacturer specific operation. The Manufacturer ID for the MCP9843/98243 is 0x0054 (hexadecimal).

REGISTER 5-6: MANUFACTURER ID REGISTER (READ-ONLY) → ADDRESS '0000 0110'b

R-0	R-0	R-0	R-0	R-0	R-0	R-0	R-0
Manufacturer ID							
bit 15				bit 8			

R-0	R-1	R-0	R-1	R-0	R-1	R-0	R-0
Manufacturer ID							
bit 7				bit 0			

Legend:

R = Readable bit W = Writable bit U = Unimplemented bit, read as '0'
 -n = Value at POR '1' = Bit is set '0' = Bit is cleared x = Bit is unknown

bit 15-0 **Device Manufacturer Identification Number**



FIGURE 5-8: Timing Diagram for Reading the Manufacturer ID Register (See Section 4.0 “Serial Communication”).

MCP9843/98243

5.1.6 DEVICE ID AND REVISION REGISTER

The upper byte of this register is used to specify the device identification and the lower byte is used to specify device revision. The device ID for the MCP98243 is 0x21 (hex) and the MCP9843 is 0x00 (hex).

The revision (Lower Byte) begins with 0x00 (hex) for the first release, with the number being incremented as revised versions are released. The revision for both MCP9843 and MCP98243 is 0x01.

REGISTER 5-7: MCP98243 DEVICE ID AND DEVICE REVISION (READ-ONLY) → ADDRESS '0000 0111'b

R-0	R-0	R-1	R-0	R-0	R-0	R-0	R-1	
Device ID								
bit 15								bit 8

R-0	R-0	R-0	R-0	R-0	R-0	R-0	R-1	
Device Revision								
bit 7								bit 0

Legend:							
R = Readable bit	W = Writable bit	U = Unimplemented bit, read as '0'					
-n = Value at POR	'1' = Bit is set	'0' = Bit is cleared	x = Bit is unknown				

bit 15-8 **Device ID:** Bit 15 to bit 8 are used for device ID
bit 7-0 **Device Revision:** Bit 7 to bit 0 are used for device revision

REGISTER 5-8: MCP9843 DEVICE ID AND DEVICE REVISION (READ-ONLY) → ADDRESS '0000 0111'b

R-0	R-0	R-0	R-0	R-0	R-0	R-0	R-0	
Device ID								
bit 15								bit 8

R-0	R-0	R-0	R-0	R-0	R-0	R-0	R-1	
Device Revision								
bit 7								bit 0

Legend:							
R = Readable bit	W = Writable bit	U = Unimplemented bit, read as '0'					
-n = Value at POR	'1' = Bit is set	'0' = Bit is cleared	x = Bit is unknown				

bit 15-8 **Device ID:** Bit 15 to bit 8 are used for device ID
bit 7-0 **Device Revision:** Bit 7 to bit 0 are used for device revision

5.1.7 RESOLUTION REGISTER

This register allows the user to change the sensor resolution (see **Section 5.2.4 “Temperature Resolution”**). The POR default resolution is 0.25°C. The selected resolution is also reflected in the Capability register (see [Register 5-2](#)).

REGISTER 5-9: RESOLUTION → ADDRESS `'0000 1000'b`

U-0	U-0	U-0	U-0	U-0	U-0	R/W-0	R/W-0
—	—	—	—	—	—	Resolution	
bit 7						bit 0	

Legend:

R = Readable bit	W = Writable bit	U = Unimplemented bit, read as '0'
-n = Value at POR	'1' = Bit is set	'0' = Bit is cleared
		x = Bit is unknown

bit 7-2 **Unimplemented:** Read as '0'

bit 1-0 **Resolution:**
 00 = LSB = 0.5°C (t_{CONV} = 30 ms typical)
 01 = LSB = 0.25°C (power up default, t_{CONV} = 65 ms typical)
 10 = LSB = 0.125°C (t_{CONV} = 130 ms typical)
 11 = LSB = 0.0625°C (t_{CONV} = 260 ms typical)



FIGURE 5-9: Timing Diagram for Changing T_A Resolution to 0.0625°C `<0000 0011>b` (See **Section 4.0 “Serial Communication”**).

MCP9843/98243

5.2 SENSOR FEATURE DESCRIPTION

5.2.1 SHUTDOWN MODE

Shutdown mode disables all power-consuming activities (including temperature sampling operations) while leaving the serial interface active. This mode is selected by setting bit 8 of CONFIG to '1'. In this mode, the device consumes I_{SHDN} . It remains in this mode until bit 8 is cleared '0' to enable Continuous Conversion mode, or until power is recycled.

The Shutdown bit (bit 8) cannot be set to '1' while bits 6 and 7 of CONFIG (Lock bits) are set to '1'. However, it can be cleared '0' or returned to Continuous Conversion while locked.

In Shutdown mode, all registers can be read or written. However, the serial bus activity increases the shutdown current.

If the device is shutdown while the Event pin is asserted, then the Event output will be de-asserted during shutdown. It will remain de-asserted until the device is enabled for normal operation. Once the device is enabled it takes t_{CONV} before the device re-asserts the Event output.

5.2.2 TEMPERATURE HYSTERESIS (T_{HYST})

A hysteresis of 0°C, 1.5°C, 3°C or 6°C can be selected for the T_{UPPER} , T_{LOWER} and T_{CRIT} temperature boundaries using bits 10 and 9 of CONFIG. The hysteresis applies for decreasing temperature only (hot to cold), or as temperature drifts below the specified limit.

The hysteresis bits can not be changed if either of the lock bits, bits 6 and 7 of CONFIG, are set to '1'.

The T_{UPPER} , T_{LOWER} and T_{CRIT} boundary conditions are described graphically in [Figure 5-2](#).

5.2.3 EVENT OUTPUT CONFIGURATION

The Event output can be enabled using bit 3 of CONFIG (Event output control bit) and can be configured as either a comparator output or as Interrupt Output mode using bit 0 of CONFIG (Event mode). The polarity can also be specified as an active-high or active-low using bit 1 of CONFIG (Event polarity). When active-high output is selected, a pull-down resistor is required on the Event pin. When active-low output is selected, a pull-up resistor is required on the Event pin, see [Figure 5-10](#) and [Figure 5-11](#) for graphical circuit description. These configurations are designed to serve processors with Low-to-High or High-to-Low edge triggered inputs. With these configurations, when the Event output De-asserts, power will not be dissipated across the pull-up or pull-down resistors.

When the ambient temperature increases above the critical temperature limit, the Event output is forced to a comparator output (regardless of bit 0 of CONFIG). When the temperature drifts below the critical temperature limit minus hysteresis, the Event output automatically returns to the state specified by bit 0 of CONFIG.



FIGURE 5-10: Active-High Event Output Configuration.



FIGURE 5-11: Active-Low Event Output Configuration.

The status of the Event output can be read using bit 4 of CONFIG (Event status). This bit can not be set to '1' in shutdown mode.

Bit 7 and 6 of the CONFIG register can be used to lock the T_{UPPER} , T_{LOWER} and T_{CRIT} registers. The bits prevent false triggers at the Event output due to an accidental rewrite to these registers.

The Event output can also be used as a critical temperature output using bit 2 of CONFIG (critical output only). When this feature is selected, the Event output becomes a comparator output. In this mode, the interrupt output configuration (bit 0 of CONFIG) is ignored.

5.2.3.1 Comparator Mode

Comparator mode is selected using bit 0 of CONFIG. In this mode, the Event output is asserted as active-high or active-low using bit 1 of CONFIG. Figure 5-12 shows the conditions that toggle the Event output.

If the device enters Shutdown mode with asserted Event output, the output will de-assert. It will remain de-asserted until the device enters Continuous Conversion mode and after the first temperature conversion is completed, t_{CONV} . After the initial temperature conversion, T_A must satisfy the T_{UPPER} or T_{LOWER} boundary conditions in order for Event output to be asserted.

Comparator mode is useful for thermostat-type applications, such as turning on a cooling fan or triggering a system shutdown when the temperature exceeds a safe operating range.

5.2.3.2 Interrupt Mode

In the Interrupt mode, the Event output is asserted as active-high or active-low (depending on the polarity configuration) when T_A drifts above or below T_{UPPER} and T_{LOWER} limits. The output is deasserted by setting bit 5 (Interrupt Clear) of CONFIG. If the device enters Shutdown mode with asserted Event output, the output will de-assert. It will remain de-asserted until the device enters Continuous Conversion mode and after the first temperature conversion is completed, t_{CONV} . If the interrupt clear bit (Bit 5) is never set, then the Event output will re-assert after the first temperature conversion.

In addition, if $T_A \geq T_{CRIT}$ the Event output is forced as Comparator mode and asserts until $T_A < T_{CRIT} - T_{HYST}$. While the Event output is asserted, user must send Clear Interrupt command (bit 5 of CONFIG) for Event output to de-assert, when temperature drops below the critical limit, $T_A < T_{CRIT} - T_{HYST}$. Otherwise, Event output remains asserted (see Figure 5-12 for graphical description). Switching from Interrupt mode to Comparator mode also de-asserts Event output.

This mode is designed for interrupt driven microcontroller based systems. The microcontroller receiving the interrupt will have to acknowledge the interrupt by setting bit 5 of CONFIG register from the MCP9843/98243.

5.2.4 TEMPERATURE RESOLUTION

The MCP9843/98243 device is capable of providing a temperature data with 0.5°C to 0.0625°C resolution. The Resolution can be selected using the Resolution register (Register 5-9) which is located in address '00001000'b. This address location is not specified in JEDEC Standard JC42.4. However, it provides additional flexibility while being functionally compatible with JC42.4 and provide a 0.25°C resolution at 125 ms (max.). The selected resolution can be read by user using bit 4 and bit 3 of the Capability register (Register 5-2). A 0.25°C resolution is set as POR default by factory.

TABLE 5-2: TEMPERATURE CONVERSION TIME

Resolution	t_{CONV} (ms)	Samples/sec (typical)
0.5°C	30	33
0.25°C (Power-up default)	65	15
0.125°C	130	8
0.0625°C	260	4

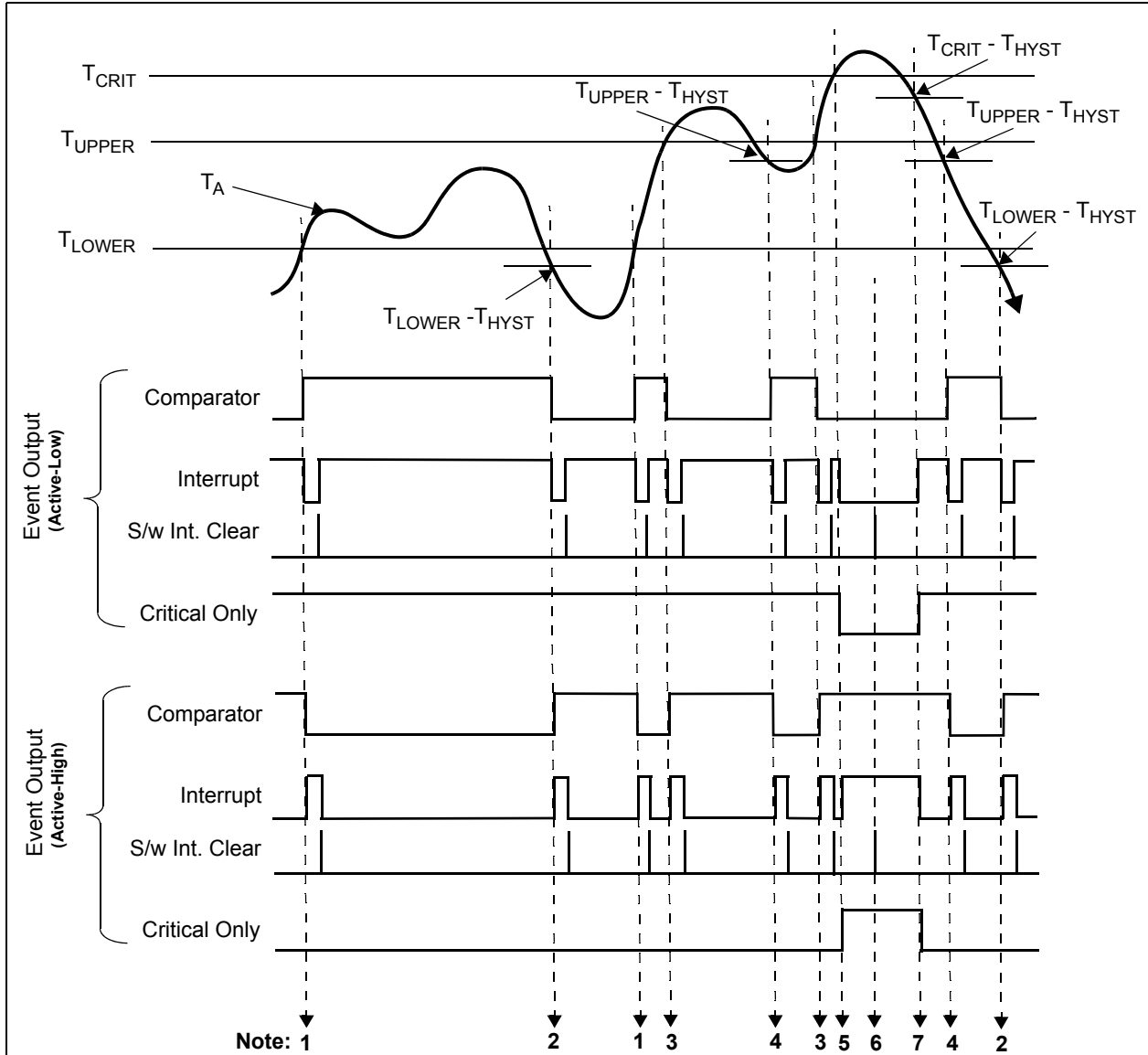

TABLE 5-10: TEMPERATURE EVENT OUTPUT CONDITIONS

Note	Output Boundary Conditions	Comparator	Interrupt	Critical	T _A Bits		
					Output State (Active Low/High)		
1	$T_A \geq T_{LOWER}$	High/Low	Low/High	High/Low	0	0	0
2	$T_A < T_{LOWER} - T_{HYST}$	Low/High	Low/High	High/Low	0	0	1
3	$T_A > T_{UPPER}$	Low/High	Low/High	High/Low	0	1	0
4	$T_A \leq T_{UPPER} - T_{HYST}$	High/Low	Low/High	High/Low	0	0	0
5	$T_A \geq T_{CRIT}$	Low/High	Low/High	Low/High	1	1	0
6	When $T_A \geq T_{CRIT}$ the Event output is forced to Comparator Mode and bits 0 of CONFIG (Event output mode) is ignored until $T_A < T_{CRIT} - T_{HYST}$. In the Interrupt Mode, if Interrupt is not cleared (bits 5 of CONFIG) as shown in the diagram at Note 6 , then Event will remain asserted at Note 7 until Interrupt is cleared by the controller.						
7	$T_A < T_{CRIT} - T_{HYST}$	Low/High	High/Low	High/Low	0	1	0

FIGURE 5-12: Event Output Condition.

5.3 MCP98243 EEPROM FEATURE DESCRIPTION

5.3.1 BYTE WRITE

To write a byte in the MCP98243 EEPROM, the master has to specify the memory location or address. Once the address byte is transmitted correctly followed by a word address, the word address is stored in the EEPROM address pointer. The following byte is data to be stored in the specified memory location. [Figure 5-13](#) shows the timing diagram.



FIGURE 5-13: Timing Diagram for Byte Write (See **Section 4.0 “Serial Communication”**).

MCP9843/98243

5.3.2 PAGE WRITE

The write Address Byte, word address and the first data byte are transmitted to the MCP98243 in the same way as in a byte write. Instead of generating a Stop condition, the master transmits up to 15 additional data bytes to the MCP98243, which are temporarily stored in the on-chip page buffer and will be written into the memory after the master has transmitted a Stop condition. Upon receipt of each word, the four lower order address pointer bits are internally incremented by one. The higher order four bits of the word address remain constant. If the master should transmit more than 16 bytes prior to generating the Stop condition, the address counter will roll over and the previously received data will be overwritten. As with the byte write operation, once the Stop condition is received, an internal write cycle will begin (Figure 5-14).

Note: Page write operations are limited to writing bytes within a single physical page, regardless of the number of bytes actually being written. Physical page boundaries start at addresses that are integer multiples of the page buffer size (or 'page size') and end at addresses that are integer multiples of [page size - 1]. If a Page Write command attempts to write across a physical page boundary, the result is that the data wraps around to the beginning of the current page (overwriting data previously stored there), instead of being written to the next page, as might be expected. It is therefore necessary for the application software to prevent page write operations that would attempt to cross a page boundary.



FIGURE 5-14: Timing Diagram for Page Write (See Section 4.0 "Serial Communication").

5.3.3 WRITE PROTECTION

The MCP98243 has a Software Write-Protect (SWP) feature that allows the lower half array (addresses 00h - 7Fh) to be write-protected or permanently write-protected (PWP). The write protected area can be cleared by sending Clear Write Protect (CWP) command. However, once the PWP is executed the protected memory can not be cleared. The device will not respond to the CWP command.

To access write protection, the device address code of the Address Byte is set to '0110' instead of '1010'. The '1010' Address code is used to access the memory area and the '0110' address code is used to access the write protection. Once the device is write protected it will not acknowledge certain commands. [Table 5-3](#) shows the corresponding Address Bytes for the write protect feature.

TABLE 5-3: WRITE PROTECT DEVICE ADDRESSING (NOTE 1)

EEPROM	Operation	Address Pins			Address Byte				
		A2	A1	A0	Address Code	Slave Address			$\overline{\text{R/W}}$
						A2	A1	A0	
SWP	WRITE	GND	GND	V _{HV}	0110	0	0	1	0
	READ								1
CWP	WRITE	GND	V _{DD}	V _{HV}	0110	0	1	1	0
	READ								1
PWP (Note)	WRITE	X	X	X	0110	X	X	X	0
	READ								1

Note 1: The Address Pins are 'X' or don't cares. However, the slave address bits need to match the address pins. For V_{HV} voltage levels, refer to [Figure 2-13](#).

TABLE 5-4: DEVICE RESPONSE WHEN WRITING DATA OR ACCESSING SWP/CWP/PWP (NOTE 1)

Status	Command	ACK	Address	ACK	Data Byte	ACK	Write Cycle
Not Protected	SWP/CWP/PWP	ACK	X	ACK	X	ACK	Yes
	Page/byte write	ACK	Address	ACK	Data	ACK	Yes
Protected with SWP	SWP	NoACK	X	NoACK	X	NoACK	No
	CWP	ACK	X	ACK	X	ACK	Yes
	PWP	ACK	X	ACK	X	ACK	Yes
	Page/byte write lower 128 bytes	ACK	Address	ACK	Data	NoACK	No
Permanently Protected	SWP/CWP/PWP	NoACK	X	NoACK	X	NoACK	No
	Page/byte write lower 128 bytes	ACK	Address	ACK	Data	NoACK	No

Note 1: X is defined as 'don't care'.

MCP9843/98243

5.3.3.1 Software Write Protect (SWP)

The SWP feature is invoked by writing to the write-protect register. This is done by sending an Address Byte similar to a normal Write command. [Figure 5-17](#) shows the timing diagram. SWP can be cleared using the CWP command. See [Section 5.3.3.2 “Clear Write Protect \(CWP\)”](#)

The Slave Address bits need to correspond to the address pin logic configuration. For SWP, a high voltage V_{HV} needs to be applied to the A0 pin and the corresponding slave address needs to be set to ‘1’, as shown in [Table 5-3](#). Both A2 and A1 pins are grounded and the corresponding slave address bits are set to ‘0’.

The device response in this mode is shown in [Table 5-4](#) and [Table 5-5](#).



FIGURE 5-15: Timing Diagram for Setting Software Write Protect (See [Section 4.0 “Serial Communication”](#)).

5.3.3.2 Clear Write Protect (CWP)

The CWP feature is invoked by writing to the clear write-protect register. This is done by sending an Address Byte similar to a normal Write command. [Figure 5-17](#) shows the timing diagram. CWP clears SWP only. PWP can not be cleared using this command.

The Slave Address bits need to correspond to the address pin logic configuration. For CWP, a high voltage V_{HV} needs to be applied to the A0 pin and the corresponding slave address needs to be set to ‘1’. The A1 pin is set to V_{DD} and the corresponding slave address bit is set to ‘1’. And A2 pins is set to ground and the corresponding slave address bits are set to ‘0’.

[Table 5-3](#) shows the bit configuration. The device response in this mode is shown in [Table 5-4](#) and [Table 5-5](#).



FIGURE 5-16: Timing Diagram for Setting Clear Write Protect (See [Section 4.0 “Serial Communication”](#)).

5.3.3.3 PWP (Permanent Write Protect)

Once the PWP register is written, the lower half of the memory will be permanent protected and the device will not acknowledge any command. The protected area of the memory can not be cleared, reversed, or re-written. If a write is attempted to the protected area, the device will acknowledge the address byte and word address but not the data byte. (See [Table 5-4](#) and [Table 5-5](#)).

Note: Once the Permanent Write-Protect is executed, it cannot be reversed, even if the device power is cycled. See [Figure 2-13](#) for V_{HV} voltage levels.

Unlike SWP and CWP, a V_{HV} is not applied on the A0 pin to execute PWP. The state of A2, A1, and A0 is user selectable. However, the address pin states need to match the slave address bits, as shown in [Table 5-3](#).



FIGURE 5-17: Timing Diagram for Setting Permanent Write Protect (See [Section 4.0 "Serial Communication"](#)).

MCP9843/98243

5.3.4 READ OPERATION

Read operations are initiated in the same way as write operations, with the exception that the R/W bit of the slave address is set to '1'. There are three basic types of read operations: current address read, random read and sequential read.

TABLE 5-5: DEVICE RESPONSE WHEN READING SWP/CWP/PWP (NOTE)

Status	Command	ACK	Address	ACK	Data Byte	ACK
Not Protected	SWP/CWP/PWP	ACK	X	NoACK	X	NoACK
Protected with SWP	SWP	NoACK	X	NoACK	X	NoACK
	CWP	ACK	X	NoACK	X	NoACK
	PWP	ACK	X	NoACK	X	NoACK
Permanently Protected	SWP/CWP/PWP	NoACK	X	NoACK	X	NoACK

Note: X is defined as 'don't care'.

5.3.4.1 Current Address Read

The MCP98243 contains an address counter that maintains the address of the last word accessed, internally incremented by '1'. Therefore, if the previous access (either a read or write operation) was to address n , the next current address read operation would access data from address $n+1$. Upon receipt of the slave address with R/W bit set to '1', the MCP98243 issues an acknowledge and transmits the 8-bit data

word. The master will not acknowledge (NAK) the transfer but does generate a Stop condition and the MCP98243 discontinues transmission (Figure 5-18).



FIGURE 5-18: Reading Current Word Address (See Section 4.0 "Serial Communication").

5.3.4.2 Random Read

Random read operations allow the master to access any memory location in a random manner. To perform this type of read operation, the word address must first be set. This is done by sending the word address to the MCP98243 as part of a write operation. Once the word address is sent, the master generates a start condition following the acknowledge. This terminates the write operation, but not before the internal address pointer is

set. The master then issues the Address Byte again, but with the R/W bit set to a '1'. The MCP98243 then issues an acknowledge and transmits the 8-bit data word. The master will not acknowledge the transfer but does generate a stop condition and the MCP98243 discontinues transmission (Figure 5-19).



FIGURE 5-19: Timing Diagram for Random Read (See Section 4.0 "Serial Communication").

MCP9843/98243

5.3.4.3 Sequential Read

Sequential reads are initiated in the same way as a random read, with the exception that after the MCP98243 transmits the first data byte, the master issues an acknowledge, as opposed to a stop condition in a random read. This directs the MCP98243 to transmit the next sequentially addressed 8-bit word (Figure 5-20).

To provide sequential reads, the MCP98243 contains an internal address pointer, which is incremented by one at the completion of each operation. This address pointer allows the entire memory contents to be serially read during one operation.



FIGURE 5-20: Timing Diagram for Sequential Read (See Section 4.0 “Serial Communication”).

5.3.5 STANDBY MODE

The design will incorporate a low power standby mode (I_{SHDN}). Standby mode will be entered after a normal termination of any operation and after all internal functions are complete. This would include any error conditions occurring, such as improper number of clock cycles or improper instruction byte as defined previously.

5.4 Summary of Power-on Default

The MCP9843/98243 has an internal Power-on Reset (POR) circuit. If the power supply voltage V_{DD} glitches down to the V_{POR_TS} and V_{POR_EE} thresholds, the device resets the registers to the power-on default settings.

Table 5-6 shows the power-on default summary for the temperature sensor. The EEPROM resets the address pointer to 0x00 hex.

TABLE 5-6: MCP9843/98243 TEMPERATURE SENSOR POWER-ON RESET DEFAULTS

Registers		Default Register Data (Hexadecimal)	Power-up Default Register Description
Address (Hexadecimal)	Register Name		
0x00	Capability	0x00EF	Event output de-asserts in shutdown I ² C time out 25 ms to 35 ms. Accepts V_{HV} at A0 Pin 0.25°C Measurement Resolution Measures temperature below 0°C ±1°C accuracy over active range Temperature event output
0x01	CONFIG	0x0000	Comparator mode Active-Low output Event and critical output Output disabled Event not asserted Interrupt cleared Event limits unlocked Critical limit unlocked Continuous conversion 0°C Hysteresis
0x02	T _{UPPER}	0x0000	0°C
0x03	T _{LOWER}	0x0000	0°C
0x04	T _{CRIT}	0x0000	0°C
0x05	T _A	0x0000	0°C
0x06	Manufacturer ID	0x0054	0x0054 (hex)
0x07	Device ID/ Device Revision for MCP98243	0x2101	0x2101 (hex)
0x07	Device ID/ Device Revision for MCP9843	0x0001	0x0001 (hex)
0x08	Resolution	0x01	0x01 (hex)

MCP9843/98243

NOTES:

6.0 APPLICATIONS INFORMATION

6.1 Layout Considerations

The MCP9843/98243 device does not require any additional components besides the master controller in order to measure temperature. However, it is recommended that a decoupling capacitor of 0.1 μF to 1 μF be used between the V_{DD} and GND pins. A high-frequency ceramic capacitor is recommended. It is necessary for the capacitor to be located as close as possible to the power and ground pins of the device in order to provide effective noise protection.

In addition, good PCB layout is key for better thermal conduction from the PCB temperature to the sensor die. For good temperature sensitivity, add a ground layer under the device pins as shown in [Figure 6-1](#).

6.2 Thermal Considerations

A potential for self-heating errors can exist if the MCP9843/98243 SDA, SCLK and Event lines are heavily loaded with pull-ups (high current). Typically, the self-heating error is negligible because of the relatively small current consumption of the MCP9843/98243. A temperature accuracy error of approximately 0.5°C could result from self-heating if the communication pins sink/source the maximum current specified.

For example, if the Event output is loaded to maximum I_{OL} , [Equation 6-1](#) can be used to determine the effect of self-heating.

EQUATION 6-1: EFFECT OF SELF-HEATING

$$T_{\Delta} = \theta_{\text{JA}}(V_{\text{DD}} \cdot I_{\text{DD}} + V_{\text{OL_Event}} \cdot I_{\text{OL_Event}} + V_{\text{OL_SDA}} \cdot I_{\text{OL_SDA}})$$

Where:

$$T_{\Delta} = T_{\text{J}} - T_{\text{A}}$$

T_{J} = Junction Temperature

T_{A} = Ambient Temperature

θ_{JA} = Package Thermal Resistance

$V_{\text{OL_Event, SDA}}$ = Event and SDA Output V_{OL}
(0.4 V_{max})

$I_{\text{OL_Event, SDA}}$ = Event and SDA Output I_{OL}
(3 mA_{max})

At room temperature ($T_{\text{A}} = +25^{\circ}\text{C}$) with maximum $I_{\text{DD}} = 500 \mu\text{A}$ and $V_{\text{DD}} = 3.6\text{V}$, the self-heating due to power dissipation T_{Δ} is 0.2°C for the DFN-8 package and 0.5°C for the TSSOP-8 package.



FIGURE 6-1: DFN Package Layout.

MCP9843/98243

NOTES:

7.0 PACKAGING INFORMATION

7.1 Package Marking Information

8-Lead 2x3x0.9 DFN

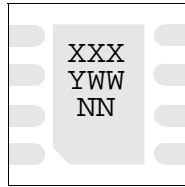

Part Number	Code
MCP9843-BE/MC	AGK
MCP9843T-BE/MC	AGK
MCP98243-BE/MC	ABZ
MCP98243T-BE/MC	ABZ

Example:

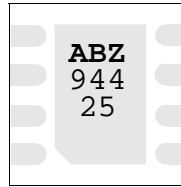

8-Lead 2x3x0.75 TDFN

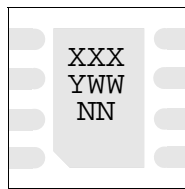

Part Number	Code
MCP9843T-BE/MNY	AAK
MCP98243T-BE/MNY	AAG

Example:

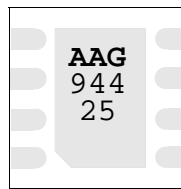

8-Lead 2x3x0.5 UDFN

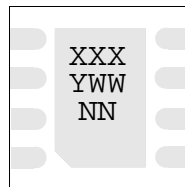

Part Number	Code
MCP98243T-BE/MUY	AAA

Example:

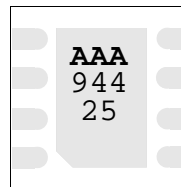

8-Lead TSSOP



Part Number	Code
MCP9843-BE/ST	05AB
MCP9843T-BE/ST	05AB
MCP98243-BE/ST	243B
MCP98243T-BE/ST	243B

Example:

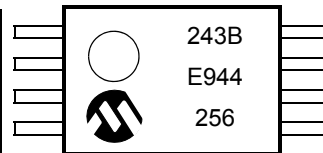

Legend: XX...X Customer-specific information
 Y Year code (last digit of calendar year)
 YY Year code (last 2 digits of calendar year)
 WW Week code (week of January 1 is week '01')
 NNN Alphanumeric traceability code
 Ⓜ Pb-free JEDEC designator for Matte Tin (Sn)
 * This package is Pb-free. The Pb-free JEDEC designator (Ⓜ) can be found on the outer packaging for this package.

Note: In the event the full Microchip part number cannot be marked on one line, it will be carried over to the next line, thus limiting the number of available characters for customer-specific information.

MCP9843/98243

8-Lead Plastic Dual Flat, No Lead Package (MC) – 2x3x0.9 mm Body [DFN]

Note: For the most current package drawings, please see the Microchip Packaging Specification located at <http://www.microchip.com/packaging>



Dimension Limits	Units	MILLIMETERS		
		MIN	NOM	MAX
Number of Pins	N	8		
Pitch	e	0.50 BSC		
Overall Height	A	0.80	0.90	1.00
Standoff	A1	0.00	0.02	0.05
Contact Thickness	A3	0.20 REF		
Overall Length	D	2.00 BSC		
Overall Width	E	3.00 BSC		
Exposed Pad Length	D2	1.30	–	1.55
Exposed Pad Width	E2	1.50	–	1.75
Contact Width	b	0.20	0.25	0.30
Contact Length	L	0.30	0.40	0.50
Contact-to-Exposed Pad	K	0.20	–	–

Notes:

- Pin 1 visual index feature may vary, but must be located within the hatched area.
- Package may have one or more exposed tie bars at ends.
- Package is saw singulated.
- Dimensioning and tolerancing per ASME Y14.5M.
 - BSC: Basic Dimension. Theoretically exact value shown without tolerances.
 - REF: Reference Dimension, usually without tolerance, for information purposes only.

Microchip Technology Drawing C04-123C

8-Lead Plastic Dual Flat, No Lead Package (MC) – 2x3x0.9 mm Body [DFN]

Note: For the most current package drawings, please see the Microchip Packaging Specification located at <http://www.microchip.com/packaging>



RECOMMENDED LAND PATTERN

Dimension Limits	Units	MILLIMETERS		
		MIN	NOM	MAX
Contact Pitch	E	0.50 BSC		
Optional Center Pad Width	W2			1.45
Optional Center Pad Length	T2			1.75
Contact Pad Spacing	C1	2.90		
Contact Pad Width (X8)	X1			0.30
Contact Pad Length (X8)	Y1			0.75
Distance Between Pads	G	0.20		

Notes:

1. Dimensioning and tolerancing per ASME Y14.5M

BSC: Basic Dimension. Theoretically exact value shown without tolerances.

Microchip Technology Drawing No. C04-2123A

MCP9843/98243

8-Lead Plastic Dual Flat, No Lead Package (MN) – 2x3x0.75 mm Body [TDFN]

Note: For the most current package drawings, please see the Microchip Packaging Specification located at <http://www.microchip.com/packaging>



Dimension Limits	Units	MILLIMETERS		
		MIN	NOM	MAX
Number of Pins	N	8		
Pitch	e	0.50 BSC		
Overall Height	A	0.70	0.75	0.80
Standoff	A1	0.00	0.02	0.05
Contact Thickness	A3	0.20 REF		
Overall Length	D	2.00 BSC		
Overall Width	E	3.00 BSC		
Exposed Pad Length	D2	1.20	-	1.60
Exposed Pad Width	E2	1.20	-	1.60
Contact Width	b	0.20	0.25	0.30
Contact Length	L	0.25	0.30	0.45
Contact-to-Exposed Pad	K	0.20	-	-

Notes:

- Pin 1 visual index feature may vary, but must be located within the hatched area.
- Package may have one or more exposed tie bars at ends.
- Package is saw singulated
- Dimensioning and tolerancing per ASME Y14.5M

BSC: Basic Dimension. Theoretically exact value shown without tolerances.

REF: Reference Dimension, usually without tolerance, for information purposes only.

Microchip Technology Drawing No. C04-129B

8-Lead Plastic Dual Flat, No Lead Package (MN) – 2x3x0.75 mm Body [TDFN]

Note: For the most current package drawings, please see the Microchip Packaging Specification located at <http://www.microchip.com/packaging>



RECOMMENDED LAND PATTERN

Dimension Limits	Units	MILLIMETERS		
		MIN	NOM	MAX
Contact Pitch	E	0.50 BSC		
Optional Center Pad Width	W2			1.46
Optional Center Pad Length	T2			1.36
Contact Pad Spacing	C1		3.00	
Contact Pad Width (X8)	X1			0.30
Contact Pad Length (X8)	Y1			0.75
Distance Between Pads	G	0.20		

Notes:

1. Dimensioning and tolerancing per ASME Y14.5M

BSC: Basic Dimension. Theoretically exact value shown without tolerances.

Microchip Technology Drawing No. C04-2129A

MCP9843/98243

8-Lead Plastic Dual Flat, No Lead Package (MU) – 2x3x0.5 mm Body [UDFN]

Note: For the most current package drawings, please see the Microchip Packaging Specification located at <http://www.microchip.com/packaging>

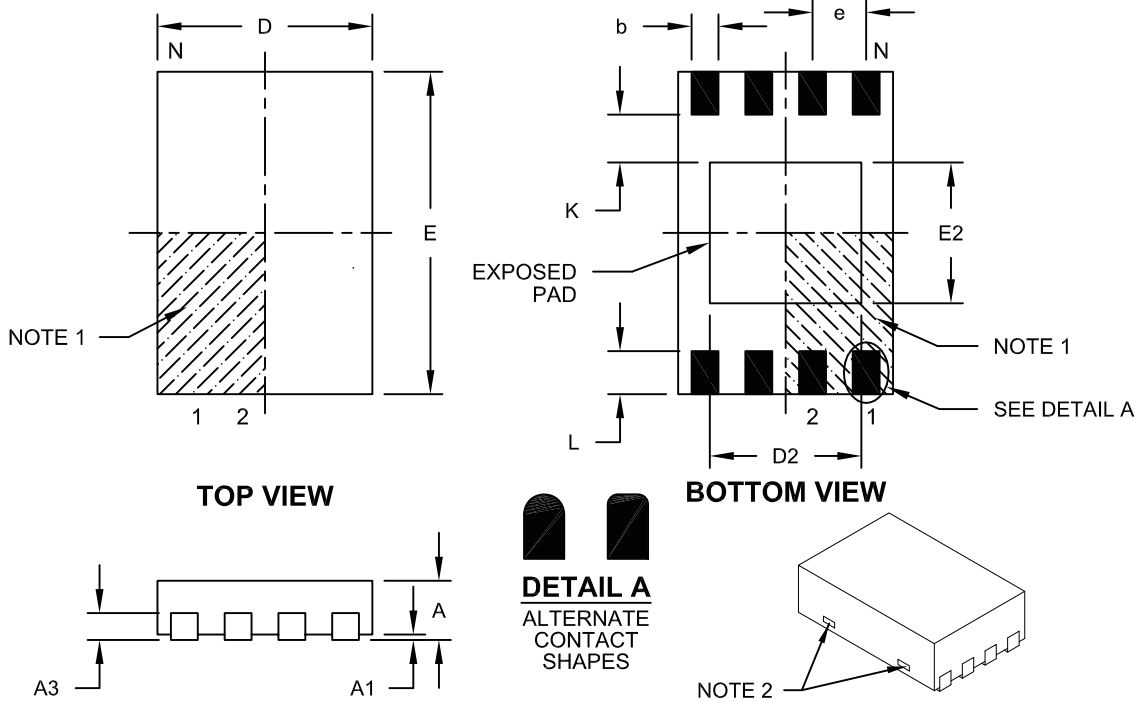

		Units	MILLIMETERS		
Dimension Limits			MIN	NOM	MAX
Number of Pins	N		8		
Pitch	e		0.50 BSC		
Overall Height	A	0.45	0.50	0.55	
Standoff	A1				0.07
Contact Thickness	A3		0.127 REF		
Overall Length	D	1.95	2.00	2.05	
Overall Width	E	2.95	3.00	3.05	
Exposed Pad Length	D2	1.30	1.40	1.50	
Exposed Pad Width	E2	1.20	1.30	1.40	
Contact Width	b	0.20	0.25	0.30	
Contact Length	L	0.25	0.30	0.35	
Contact-to-Exposed Pad	K		0.55 REF		

Notes:

1. Pin 1 visual index feature may vary, but must be located within the hatched area.
2. Package may have one or more exposed tie bars at ends.
3. Package is saw singulated
4. Dimensioning and tolerancing per ASME Y14.5M
 - BSC: Basic Dimension. Theoretically exact value shown without tolerances.
 - REF: Reference Dimension, usually without tolerance, for information purposes only.

Microchip Technology Drawing No. C04-136B

8-Lead Plastic Dual Flat, No Lead Package (MU) – 2x3x0.5 mm Body [UDFN]

Note: For the most current package drawings, please see the Microchip Packaging Specification located at <http://www.microchip.com/packaging>

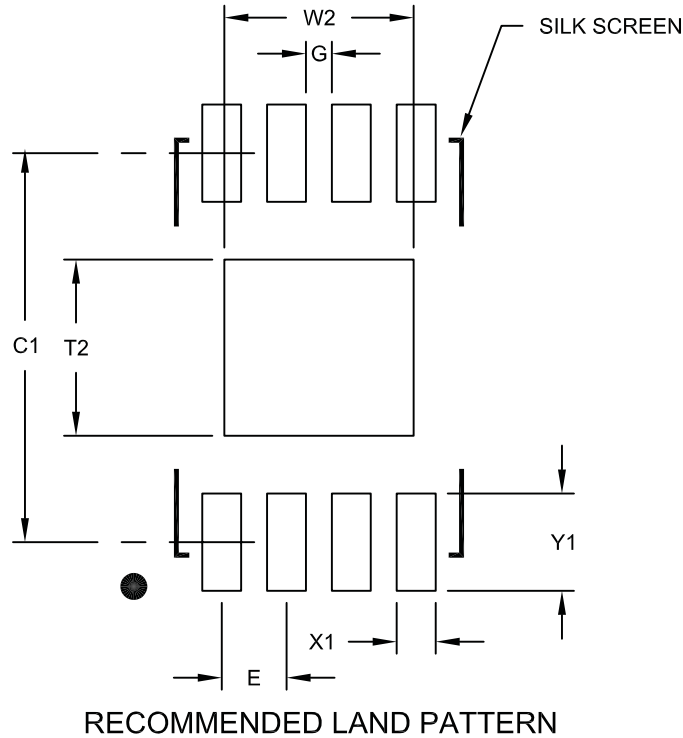

Dimension Limits	Units	MILLIMETERS		
		MIN	NOM	MAX
Contact Pitch	E	0.50 BSC		
Optional Center Pad Width	W2			1.46
Optional Center Pad Length	T2			1.36
Contact Pad Spacing	C1		3.00	
Contact Pad Width (X8)	X1			0.30
Contact Pad Length (X8)	Y1			0.75
Distance Between Pads	G	0.20		

Notes:

1. Dimensioning and tolerancing per ASME Y14.5M

BSC: Basic Dimension. Theoretically exact value shown without tolerances.

Microchip Technology Drawing No. C04-2136A

MCP9843/98243

8-Lead Plastic Thin Shrink Small Outline (ST) – 4.4 mm Body [TSSOP]

Note: For the most current package drawings, please see the Microchip Packaging Specification located at <http://www.microchip.com/packaging>



Dimension Limits	Units	MILLIMETERS		
		MIN	NOM	MAX
Number of Pins	N	8		
Pitch	e	0.65 BSC		
Overall Height	A	–	–	1.20
Molded Package Thickness	A2	0.80	1.00	1.05
Standoff	A1	0.05	–	0.15
Overall Width	E	6.40 BSC		
Molded Package Width	E1	4.30	4.40	4.50
Molded Package Length	D	2.90	3.00	3.10
Foot Length	L	0.45	0.60	0.75
Footprint	L1	1.00 REF		
Foot Angle	ϕ	0°	–	8°
Lead Thickness	c	0.09	–	0.20
Lead Width	b	0.19	–	0.30

Notes:

- Pin 1 visual index feature may vary, but must be located within the hatched area.
- Dimensions D and $E1$ do not include mold flash or protrusions. Mold flash or protrusions shall not exceed 0.15 mm per side.
- Dimensioning and tolerancing per ASME Y14.5M.

BSC: Basic Dimension. Theoretically exact value shown without tolerances.

REF: Reference Dimension, usually without tolerance, for information purposes only.

Microchip Technology Drawing C04-086B

8-Lead Plastic Thin Shrink Small Outline (ST) - 4.4 mm Body [TSSOP]

Note: For the most current package drawings, please see the Microchip Packaging Specification located at <http://www.microchip.com/packaging>



RECOMMENDED LAND PATTERN

Units		MILLIMETERS		
Dimension Limits		MIN	NOM	MAX
Contact Pitch	E		0.65 BSC	
Contact Pad Spacing	C1		5.90	
Contact Pad Width (X28)	X1			0.45
Contact Pad Length (X28)	Y1			1.45
Distance Between Pads	G	0.20		

Notes:

1. Dimensioning and tolerancing per ASME Y14.5M

BSC: Basic Dimension. Theoretically exact value shown without tolerances.

Microchip Technology Drawing No. C04-2086A

MCP9843/98243

NOTES:

APPENDIX A: REVISION HISTORY

Revision C (November 2009)

The following is the list of modifications:

1. Added the MCP9843 temperature sensor and updated all specification and description sections to include this device.
2. Updated [Table 5-1](#) and [Table 5-6](#) with information on the MCP9843 device.
3. Added [Register 5-8](#) for MCP9843 device.
4. Updated [Section 7.1 “Package Marking Information”](#).

Revision B (October 2009)

The following is the list of modifications:

1. Added MCP98243 vs MCP98242 comparison table.
2. Added EEPROM Write temperature Range.
3. Changed I²C time out minimum specification to 25 ms.
4. Replaced [Figure 2-5](#).
5. Updated bits 7 and 6 of [Register 5-2: Capability Register](#).
6. Updated Device/Revision ID register.
7. Updated Functional Block Diagram ([Figure 5-1](#)).
8. Updated [Section 5.2.3.1 “Comparator Mode”](#) and [Section 5.2.3.2 “Interrupt Mode”](#).
9. Updated [Figure 5-13](#).
10. Updated package marking drawings.

Revision A (May 2009)

- Original Release of this Document.

MCP9843/98243

NOTES:

PRODUCT IDENTIFICATION SYSTEM

To order or obtain information, e.g., on pricing or delivery, refer to the factory or the listed sales office.

<u>PART NO.</u>	<u>-X</u>	<u>X</u>	<u>/XXX</u>	Examples:
Device	Grade	Temperature Range	Package	
Device:				a) MCP9843-BE/MC: Extended Temp., 8LD DFN pkg.
				b) MCP9843T-BE/MC: Tape and Reel, Extended Temp., 8LD DFN pkg.
				c) MCP9843-BE/ST: Extended Temp., 8LD TSSOP pkg.
				d) MCP9843T-BE/ST: Tape and Reel, Extended Temp., 8LD TSSOP pkg.
Grade:	B	= ±1°C (max.) from +75°C to +95°C, ±2°C (max.) from +40°C to +125°C, and ±3°C (max.) from -20°C to +125°C		e) MCP9843T-BE/MNY: Tape and Reel, Extended Temp., 8LD TDFN (nickel palladium gold) pkg.
Temperature Range:	E	= -40°C to +125°C		
Package:	MC	= Dual Flat No Lead (2x3x0.9 mm Body), 8-lead,		a) MCP98243-BE/MC: Extended Temp., 8LD DFN pkg.
	MNY *	= Dual Flat No Lead (2x3x0.75 mm Body), 8-lead (Tape and Reel)		b) MCP98243T-BE/MC: Tape and Reel, Extended Temp., 8LD DFN pkg.
	MUY *	= Dual Flat No Lead (2x3x0.5 mm Body), 8-lead (Tape and Reel)		c) MCP98243-BE/ST: Extended Temp., 8LD TSSOP pkg.
	ST	= Plastic Thin Shrink Small Outline (4x4 mm Body), 8-lead		d) MCP98243T-BE/ST: Tape and Reel, Extended Temp., 8LD TSSOP pkg.
		* Y = nickel palladium gold manufacturing designator. Only available on the TDFN and UDFN packages.		e) MCP98243T-BE/MNY: Tape and Reel, Extended Temp., 8LD TDFN (nickel palladium gold) pkg.
				f) MCP98243T-BE/MUY: Tape and Reel, Extended Temp., 8LD UDFN (nickel palladium gold) pkg.

MCP9843/98243

NOTES:

Note the following details of the code protection feature on Microchip devices:

- Microchip products meet the specification contained in their particular Microchip Data Sheet.
- Microchip believes that its family of products is one of the most secure families of its kind on the market today, when used in the intended manner and under normal conditions.
- There are dishonest and possibly illegal methods used to breach the code protection feature. All of these methods, to our knowledge, require using the Microchip products in a manner outside the operating specifications contained in Microchip's Data Sheets. Most likely, the person doing so is engaged in theft of intellectual property.
- Microchip is willing to work with the customer who is concerned about the integrity of their code.
- Neither Microchip nor any other semiconductor manufacturer can guarantee the security of their code. Code protection does not mean that we are guaranteeing the product as “unbreakable.”

Code protection is constantly evolving. We at Microchip are committed to continuously improving the code protection features of our products. Attempts to break Microchip's code protection feature may be a violation of the Digital Millennium Copyright Act. If such acts allow unauthorized access to your software or other copyrighted work, you may have a right to sue for relief under that Act.

Information contained in this publication regarding device applications and the like is provided only for your convenience and may be superseded by updates. It is your responsibility to ensure that your application meets with your specifications. MICROCHIP MAKES NO REPRESENTATIONS OR WARRANTIES OF ANY KIND WHETHER EXPRESS OR IMPLIED, WRITTEN OR ORAL, STATUTORY OR OTHERWISE, RELATED TO THE INFORMATION, INCLUDING BUT NOT LIMITED TO ITS CONDITION, QUALITY, PERFORMANCE, MERCHANTABILITY OR FITNESS FOR PURPOSE. Microchip disclaims all liability arising from this information and its use. Use of Microchip devices in life support and/or safety applications is entirely at the buyer's risk, and the buyer agrees to defend, indemnify and hold harmless Microchip from any and all damages, claims, suits, or expenses resulting from such use. No licenses are conveyed, implicitly or otherwise, under any Microchip intellectual property rights.

Trademarks

The Microchip name and logo, the Microchip logo, dsPIC, KEELOQ, KEELOQ logo, MPLAB, PIC, PICmicro, PICSTART, rPIC and UNI/O are registered trademarks of Microchip Technology Incorporated in the U.S.A. and other countries.

FilterLab, Hampshire, HI-TECH C, Linear Active Thermistor, MXDEV, MXLAB, SEEVAL and The Embedded Control Solutions Company are registered trademarks of Microchip Technology Incorporated in the U.S.A.

Analog-for-the-Digital Age, Application Maestro, CodeGuard, dsPICDEM, dsPICDEM.net, dsPICworks, dsSPEAK, ECAN, ECONOMONITOR, FanSense, HI-TIDE, In-Circuit Serial Programming, ICSP, Mindi, MiWi, MPASM, MPLAB Certified logo, MPLIB, MPLINK, mTouch, Octopus, Omniscient Code Generation, PICC, PICC-18, PICDEM, PICDEM.net, PICkit, PICtail, PIC³² logo, REAL ICE, rLAB, Select Mode, Total Endurance, TSHARC, UniWinDriver, WiperLock and ZENA are trademarks of Microchip Technology Incorporated in the U.S.A. and other countries.

SQTP is a service mark of Microchip Technology Incorporated in the U.S.A.

All other trademarks mentioned herein are property of their respective companies.

© 2009, Microchip Technology Incorporated, Printed in the U.S.A., All Rights Reserved.

 Printed on recycled paper.

**QUALITY MANAGEMENT SYSTEM
CERTIFIED BY DNV
== ISO/TS 16949:2002 ==**

Microchip received ISO/TS-16949:2002 certification for its worldwide headquarters, design and wafer fabrication facilities in Chandler and Tempe, Arizona; Gresham, Oregon and design centers in California and India. The Company's quality system processes and procedures are for its PIC[®] MCUs and dsPIC[®] DSCs, KEELOQ[®] code hopping devices, Serial EEPROMs, microperipherals, nonvolatile memory and analog products. In addition, Microchip's quality system for the design and manufacture of development systems is ISO 9001:2000 certified.



WORLDWIDE SALES AND SERVICE

AMERICAS

Corporate Office
2355 West Chandler Blvd.
Chandler, AZ 85224-6199
Tel: 480-792-7200
Fax: 480-792-7277
Technical Support:
<http://support.microchip.com>
Web Address:
www.microchip.com

Atlanta
Duluth, GA
Tel: 678-957-9614
Fax: 678-957-1455

Boston
Westborough, MA
Tel: 774-760-0087
Fax: 774-760-0088

Chicago
Itasca, IL
Tel: 630-285-0071
Fax: 630-285-0075

Cleveland
Independence, OH
Tel: 216-447-0464
Fax: 216-447-0643

Dallas
Addison, TX
Tel: 972-818-7423
Fax: 972-818-2924

Detroit
Farmington Hills, MI
Tel: 248-538-2250
Fax: 248-538-2260

Kokomo
Kokomo, IN
Tel: 765-864-8360
Fax: 765-864-8387

Los Angeles
Mission Viejo, CA
Tel: 949-462-9523
Fax: 949-462-9608

Santa Clara
Santa Clara, CA
Tel: 408-961-6444
Fax: 408-961-6445

Toronto
Mississauga, Ontario,
Canada
Tel: 905-673-0699
Fax: 905-673-6509

ASIA/PACIFIC

Asia Pacific Office
Suites 3707-14, 37th Floor
Tower 6, The Gateway
Harbour City, Kowloon
Hong Kong
Tel: 852-2401-1200
Fax: 852-2401-3431

Australia - Sydney
Tel: 61-2-9868-6733
Fax: 61-2-9868-6755

China - Beijing
Tel: 86-10-8528-2100
Fax: 86-10-8528-2104

China - Chengdu
Tel: 86-28-8665-5511
Fax: 86-28-8665-7889

China - Hong Kong SAR
Tel: 852-2401-1200
Fax: 852-2401-3431

China - Nanjing
Tel: 86-25-8473-2460
Fax: 86-25-8473-2470

China - Qingdao
Tel: 86-532-8502-7355
Fax: 86-532-8502-7205

China - Shanghai
Tel: 86-21-5407-5533
Fax: 86-21-5407-5066

China - Shenyang
Tel: 86-24-2334-2829
Fax: 86-24-2334-2393

China - Shenzhen
Tel: 86-755-8203-2660
Fax: 86-755-8203-1760

China - Wuhan
Tel: 86-27-5980-5300
Fax: 86-27-5980-5118

China - Xiamen
Tel: 86-592-2388138
Fax: 86-592-2388130

China - Xian
Tel: 86-29-8833-7252
Fax: 86-29-8833-7256

China - Zhuhai
Tel: 86-756-3210040
Fax: 86-756-3210049

ASIA/PACIFIC

India - Bangalore
Tel: 91-80-3090-4444
Fax: 91-80-3090-4080

India - New Delhi
Tel: 91-11-4160-8631
Fax: 91-11-4160-8632

India - Pune
Tel: 91-20-2566-1512
Fax: 91-20-2566-1513

Japan - Yokohama
Tel: 81-45-471- 6166
Fax: 81-45-471-6122

Korea - Daegu
Tel: 82-53-744-4301
Fax: 82-53-744-4302

Korea - Seoul
Tel: 82-2-554-7200
Fax: 82-2-558-5932 or
82-2-558-5934

Malaysia - Kuala Lumpur
Tel: 60-3-6201-9857
Fax: 60-3-6201-9859

Malaysia - Penang
Tel: 60-4-227-8870
Fax: 60-4-227-4068

Philippines - Manila
Tel: 63-2-634-9065
Fax: 63-2-634-9069

Singapore
Tel: 65-6334-8870
Fax: 65-6334-8850

Taiwan - Hsin Chu
Tel: 886-3-6578-300
Fax: 886-3-6578-370

Taiwan - Kaohsiung
Tel: 886-7-536-4818
Fax: 886-7-536-4803

Taiwan - Taipei
Tel: 886-2-2500-6610
Fax: 886-2-2508-0102

Thailand - Bangkok
Tel: 66-2-694-1351
Fax: 66-2-694-1350

EUROPE

Austria - Wels
Tel: 43-7242-2244-39
Fax: 43-7242-2244-393

Denmark - Copenhagen
Tel: 45-4450-2828
Fax: 45-4485-2829

France - Paris
Tel: 33-1-69-53-63-20
Fax: 33-1-69-30-90-79

Germany - Munich
Tel: 49-89-627-144-0
Fax: 49-89-627-144-44

Italy - Milan
Tel: 39-0331-742611
Fax: 39-0331-466781

Netherlands - Drunen
Tel: 31-416-690399
Fax: 31-416-690340

Spain - Madrid
Tel: 34-91-708-08-90
Fax: 34-91-708-08-91

UK - Wokingham
Tel: 44-118-921-5869
Fax: 44-118-921-5820

03/26/09