

Preliminary



- No Matching Network Required for 50 Ω Operation
- Surface-mount 3.0 x 3.0 mm Package
- Complies with Directive 2002/95/EC (RoHS)



SF2211E

1200 MHz SAW Filter

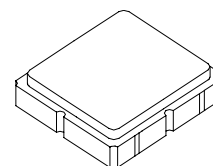

SM3030-6

Absolute Maximum Ratings

Rating	Value	Units
Input Power Level	10	dBm
DC Voltage on any Non-ground Terminal	3	V
Operating Temperature Range	-55 to +85	$^{\circ}$ C
Storage Temperature Range in Tape and Reel	-40 to +85	$^{\circ}$ C
Component Storage Temperature Range	-55 to +95	$^{\circ}$ C
Solder Reflow Temperature, 10 seconds, 5 cycles maximum	260	$^{\circ}$ C

Electrical Characteristics

Characteristic	Sym	Notes	Min	Typ	Max	Units
Center Frequency	f_c			1200		MHz
Insertion Loss, 1180 to 1220 MHz	IL			2.8	4.0	dB
Attenuation, 0 dB Reference:						dB
1080 MHz			35	60		
1100 MHz			45	60		
1300 MHz			40	48		
1320 MHz			35	52		
Source Impedance	Z_s			50		Ω
Load Impedance	Z_L			50		
Case Style	SM3030-6 3.0 x 3.0 mm Nominal Footprint					
Lid Symbolization (Y=year, WW=week, S=shift) dot=pin 1 indicator	945, YWWS					
Standard Reel Quantity	Reel Size 7 Inch					500 Pieces/Reel
	Reel Size 13 Inch					3000 Pieces/Reel

Electrical Connections

Connection	Terminals
Port 1	2
Port 2	5
Case Ground	All others

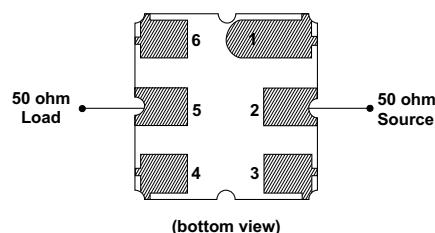

CAUTION: Electrostatic Sensitive Device. Observe precautions for handling.

Notes:

1. Unless noted otherwise, all specifications apply over the operating temperature range with filter soldered to the specified demonstration board with impedance matching to 50 Ω and measured with 50 Ω network analyzer.
2. Unless noted otherwise, all frequency specifications are referenced to the nominal center frequency, f_c .
3. Rejection is measured as attenuation below the minimum IL point in the passband. Rejection in final user application is dependent on PCB layout and external impedance matching design. See Application Note No. 42 for details.
4. "LRIP" or "L" after the part number indicates "low rate initial production" and "ENG" or "E" indicates "engineering prototypes."
5. The design, manufacturing process, and specifications of this filter are subject to change.
6. Either Port 1 or Port 2 may be used for either input or output in the design. However, impedances and impedance matching may vary between Port 1 and Port 2, so that the filter must always be installed in one direction per the circuit design.
7. US and international patents may apply.
8. RFM, stylized RFM logo, and RF Monolithics, Inc., are registered trademarks of RF Monolithics, Inc.

Filter Frequency Response

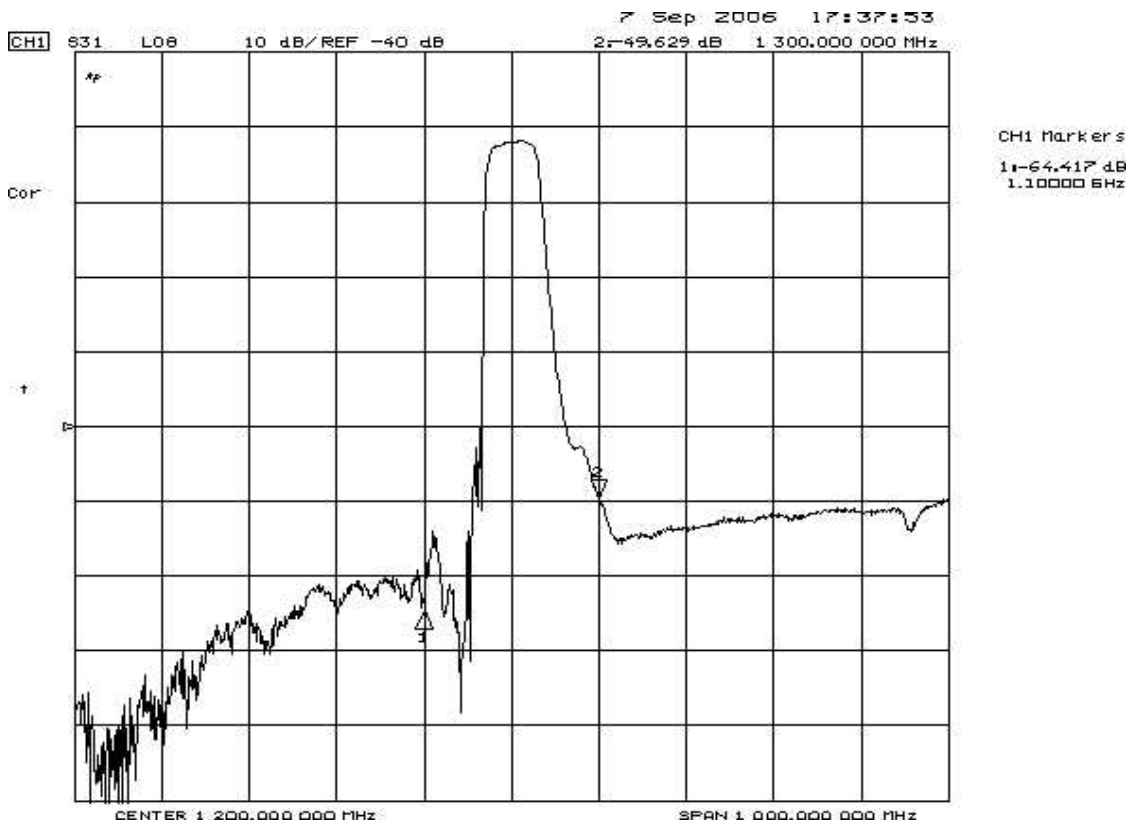

Filter Input Impedance

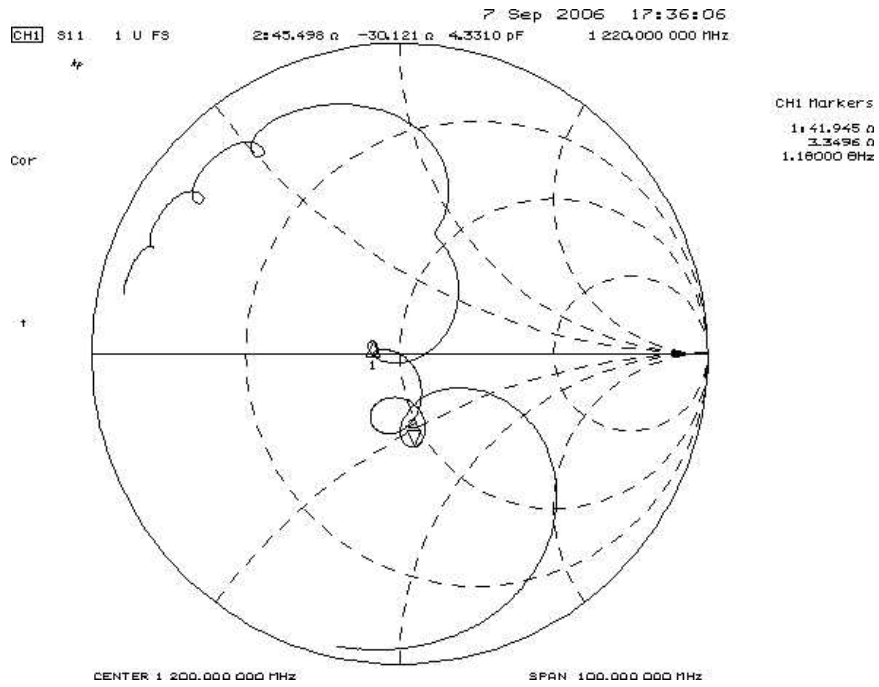

Filter Output Impedance

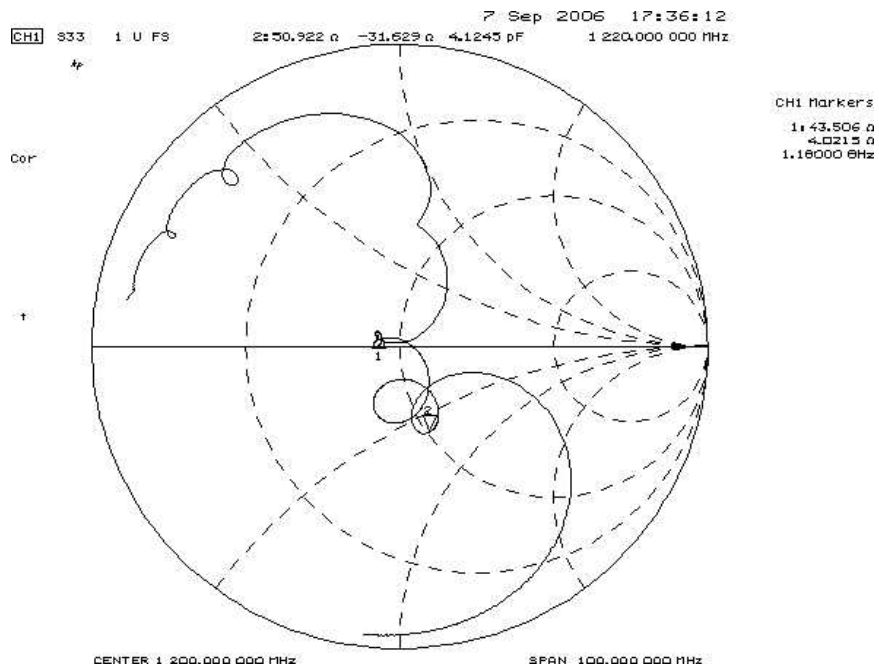

SM3030-6 Case

6-Terminal Ceramic Surface-Mount Case

3.0 X 3.0 mm Nominal Footprint

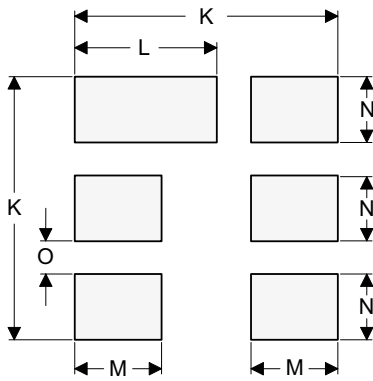
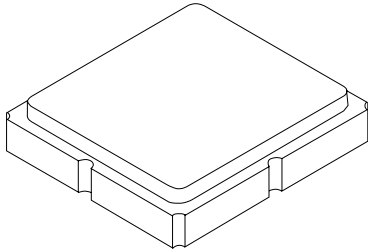

PCB Footprint Top View

Case and PCB Footprint Dimensions

Dimension	mm			Inches		
	Min	Nom	Max	Min	Nom	Max
A	2.87	3.00	3.13	0.113	0.118	0.123
B	2.87	3.00	3.13	0.113	0.118	0.123
C	1.12	1.25	1.38	0.044	0.049	0.054
D	0.77	0.90	1.03	0.030	0.035	0.040
E	2.67	2.80	2.93	0.105	0.110	0.115
F	1.47	1.60	1.73	0.058	0.063	0.068
G	0.72	0.85	0.98	0.028	0.033	0.038
H	1.37	1.50	1.63	0.054	0.059	0.064
I	0.47	0.60	0.73	0.019	0.024	0.029
J	1.17	1.30	1.43	0.046	0.051	0.056
K		3.20			0.126	
L		1.70			0.067	
M		1.05			0.041	
N		0.81			0.032	
O		0.38			0.015	

Case Materials

Materials	
Solder Pad Plating	0.3 to 1.0 μ m Gold over 1.27 to 8.89 μ m Nickel
Lid Plating	2.0 to 3.0 μ m Nickel
Body	Al ₂ O ₃ Ceramic
Pb Free	

Top View

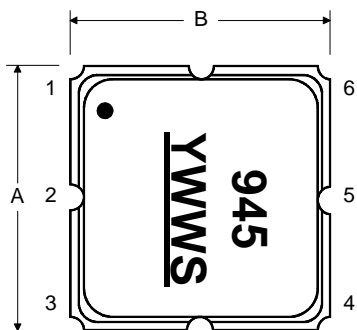

Bottom View

