

## CPDER5V0C-HF

RoHS Device  
Halogen Free

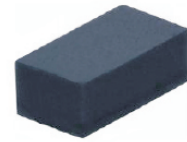

### Features

- Bi-directional ESD protection.
- Surface mount package.
- Operating voltage: 5V.

### Mechanical data

- Case: 0503/SOD-723F standard package, molded plastic.
- Terminals: Gold plated, solderable per MIL-STD-750, method 2026.
- Marking Code:  
CPDER5V0C-HF: E05
- Mounting position: Any.
- Weight: 0.002 gram (approx.).

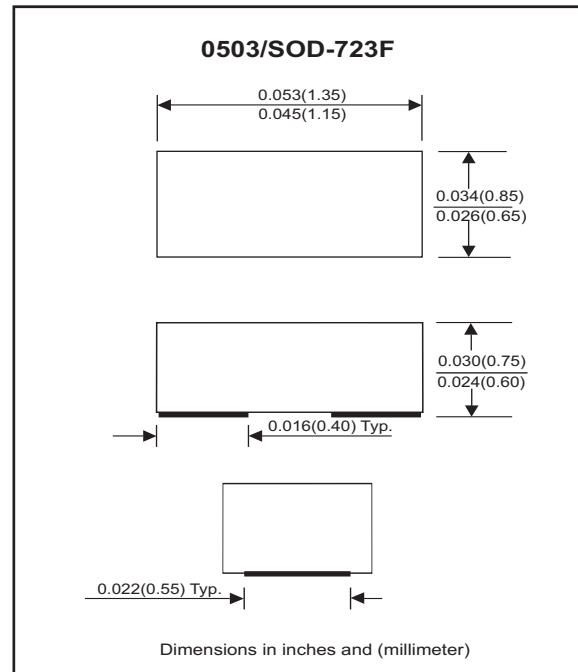

### Electrical Characteristics (at TA=25°C unless otherwise noted)

Parameter	Conditions	Symbol	Min	Typ	Max	Unit
Diode breakdown voltage	I <sub>R</sub> = 1mA	V <sub>BD</sub>	6.1	7.0		V
Leakage current	V <sub>R</sub> = 5V	I <sub>L</sub>		0.1	2.0	uA
Junction capacitance	V <sub>R</sub> = 0V, f = 1MHz	C <sub>T</sub>		25	30	pF
ESD capability	IEC 61000-4-2(air) IEC 61000-4-2(contact)	ESD			16 8	kV
Operation temperature		T <sub>j</sub>			125	°C
Storage temperature		T <sub>STG</sub>	-55		150	°C

## RATING AND CHARACTERISTIC CURVES (CPDER5V0C-HF)

Fig. 1 - Reverse characteristics

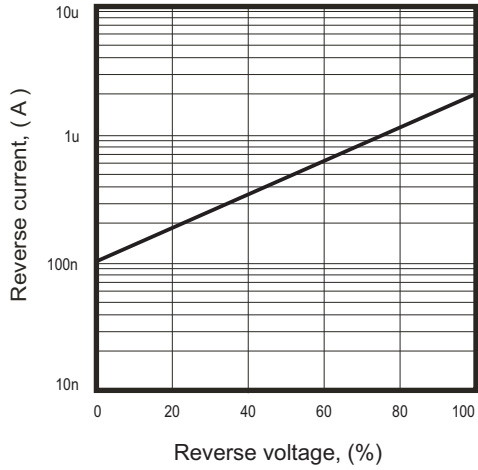

Fig. 2 - Capacitance between terminals characteristics

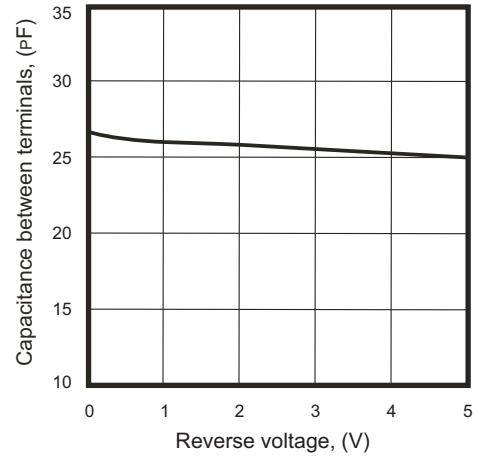
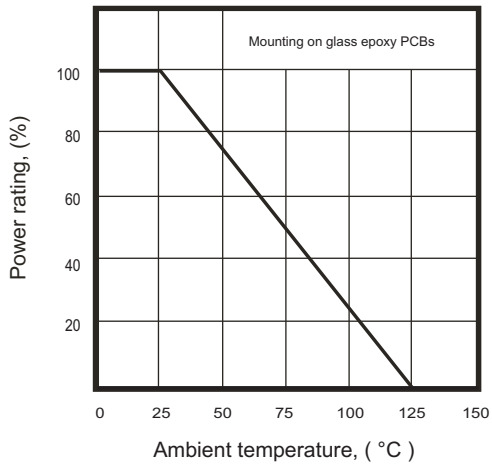
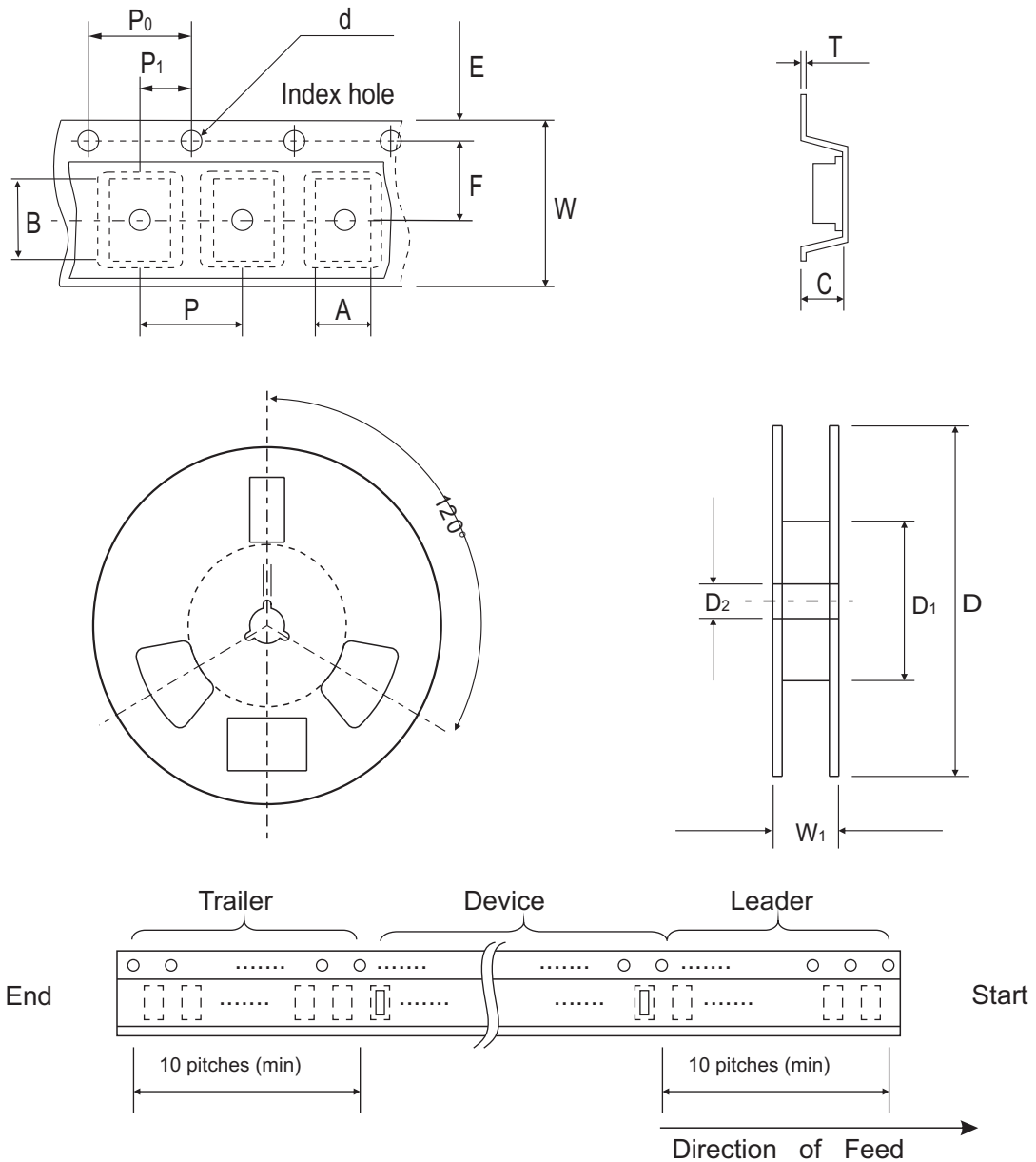

Fig. 3 - Power rating derating curve



## Reel Taping Specification



0503 (SOD-723F)	SYMBOL	A	B	C	d	D	D <sub>1</sub>	D <sub>2</sub>
	(mm)	0.90 ± 0.10	1.46 ± 0.10	0.80 ± 0.10	1.55 ± 0.05	178 ± 1	60.0 MIN.	13.0 ± 0.20
	(inch)	0.035 ± 0.004	0.057 ± 0.004	0.031 ± 0.004	0.061 ± 0.002	7.008 ± 0.04	2.362 MIN.	0.512 ± 0.008

0503 (SOD-723F)	SYMBOL	E	F	P	P <sub>0</sub>	P <sub>1</sub>	T	W	W <sub>1</sub>
	(mm)	1.75 ± 0.10	3.50 ± 0.05	4.00 ± 0.10	4.00 ± 0.10	2.00 ± 0.10	0.22 ± 0.05	8.00 ± 0.20	13.5 MAX.
	(inch)	0.069 ± 0.004	0.138 ± 0.002	0.157 ± 0.004	0.157 ± 0.004	0.079 ± 0.004	0.008 ± 0.002	0.315 ± 0.008	0.531 MAX.

## Marking Code

Part Number	Marking Code
CPDER5V0C-HF	E05

E05

## Suggested PAD Layout

SIZE	0503/SOD-723F	
	(mm)	(inch)
A	0.85	0.033
B	0.55	0.022
C	0.85	0.033
D	1.40	0.055
E	0.30	0.012

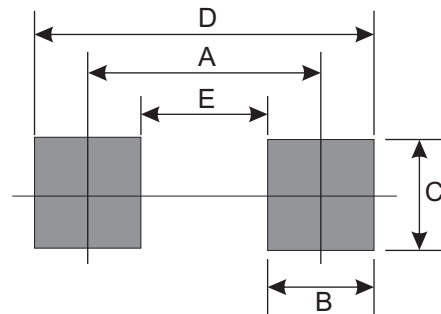

## Standard Packaging

Case Type	Qty Per Reel	Reel Size
	(Pcs)	(inch)
0503/SOD-723F	4,000	7