

GSA1015

PNP EPITAXIAL PLANAR TRANSISTOR

Description

The GSA1015 is designed for use in driver stage of AF amplifier and general purpose applications.

Features

*Collector-Base Voltage: $V_{CBO} = -50V$

*Complementary to GSC1815

Package Dimensions

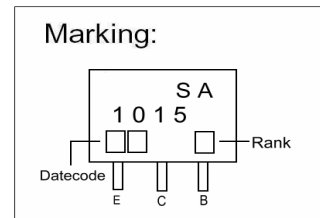
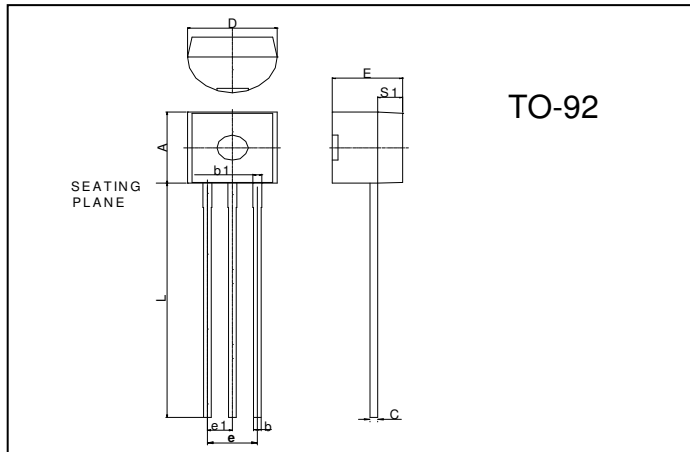

REF.	Millimeter		REF.	Millimeter	
	Min.	Max.		Min.	Max.
A	4.45	4.7	D	4.44	4.7
S1	1.02	-	E	3.30	3.81
b	0.36	0.51	L	12.70	-
b1	0.36	0.76	e1	1.150	1.390
C	0.36	0.51	e	2.42	2.66

Absolute Maximum Ratings at $T_a = 25^\circ C$

Parameter	Symbol	Ratings	Unit
Junction Temperature	T_j	+150	$^\circ C$
Storage Temperature	T_{stg}	-55 ~ +150	$^\circ C$
Collector to Base Voltage	V_{CBO}	-50	V
Collector to Emitter Voltage	V_{CEO}	-50	V
Emitter to Base Voltage	V_{EBO}	-5	V
Collector Current	I_C	-150	mA
Base Current	I_B	-50	mA
Total Power Dissipation	P_D	400	mW

Characteristics at $T_a = 25^\circ C$

Symbol	Min.	Typ.	Max.	Unit	Test Conditions
V_{CBO}	-50	-	-	V	$I_C = -100\mu A, I_E = 0$
V_{CEO}	-50	-	-	V	$I_C = -1mA, I_B = 0$
V_{EBO}	-5	-	-	V	$I_E = -10\mu A, I_C = 0$
I_{CBO}	-	-	-100	nA	$V_{CE} = -50V, I_E = 0$
I_{EBO}	-	-	-100	nA	$V_{EB} = -5V, I_C = 0$
* $V_{CE(sat)}$	-	-	-0.3	V	$I_C = -100mA, I_B = -10mA$
* $V_{BE(sat)}$	-	-	-1.1	V	$I_C = -100mA, I_B = -10mA$
hFE1	70	-	700		$V_{CE} = -6V, I_C = -2mA$
hFE2	25	-	-		$V_{CE} = -6V, I_C = -150mA$
fT	80	-	-	MHz	$V_{CE} = -10V, I_C = -1mA, f = 100MHz$
Cob	-	-	7.0	pF	$V_{CB} = -10V, I_E = 0, f = 1MHz$

* Pulse Test: Pulse Width $\leq 380\mu s$, Duty Cycle $\leq 2\%$

Classification OF hFE1

Rank	O	Y	GR	L
Range	70-140	120-240	200-400	350-700

Characteristics Curve

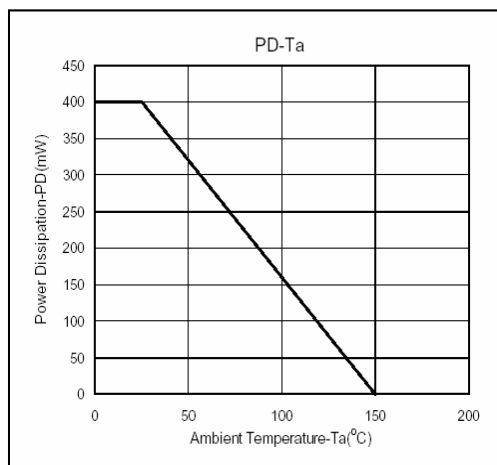
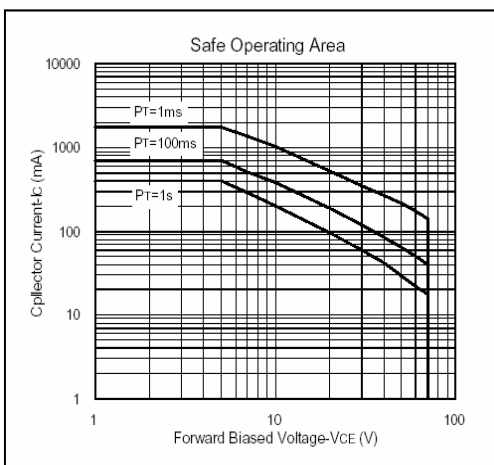
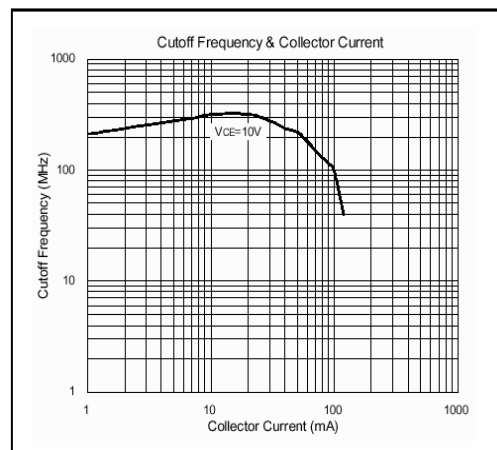
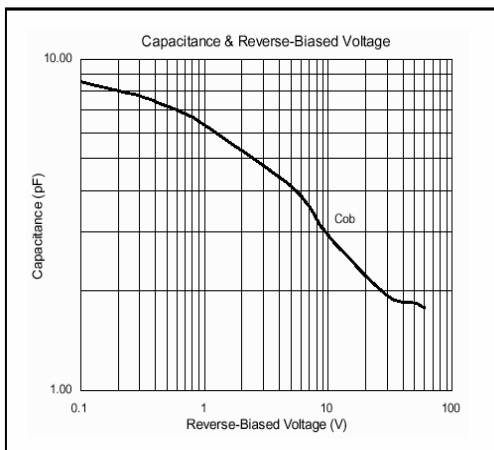
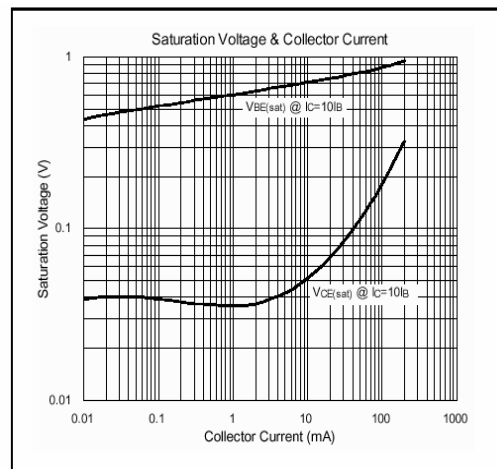
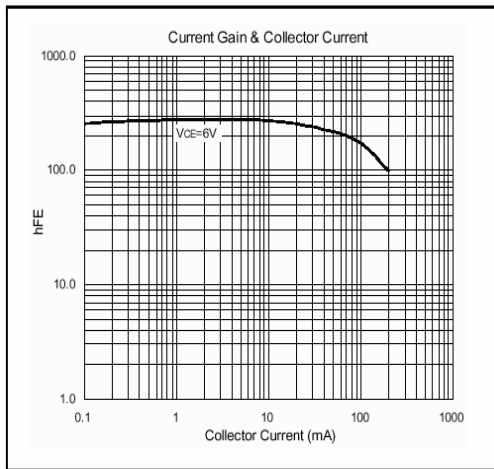

Important Notice:

- All rights are reserved. Reproduction in whole or in part is prohibited without the prior written approval of GTM.
- GTM reserves the right to make changes to its products without notice.
- GTM semiconductor products are not warranted to be suitable for use in life-support Applications, or systems.
- GTM assumes no liability for any consequence of customer product design, infringement of patents, or application assistance.

Head Office And Factory:

- **Taiwan:** No. 17-1 Tatung Rd. Fu Kou Hsin-Chu Industrial Park, Hsin-Chu, Taiwan, R. O. C.
- TEL : 886-3-597-7061 FAX : 886-3-597-9220, 597-0785
- **China:** (201203) No.255, Jang-Jiang Tsai-Lueng RD. , Pu-Dung-Hsin District, Shang-Hai City, China
- TEL : 86-21-5895-7671 ~ 4 FAX : 86-21-38950165