

# INTRODUCTORY

SPECIFICATIONS BASED ON EVALUATION OF LIMITED NUMBER OF DEVICES.



## Single/Dual/Quad High-Speed, Fast-Settling, High Output Current Operational Amplifier

### General Description

The MAX408/428/448 are high speed general purpose monolithic operational amplifiers in a single, dual or quad package, that are useful for signal frequencies extending into the video range. These Op Amps function in gain configurations greater-than or equal-to 3. High output current allows large capacitive loads to be driven at high speeds.

Open-loop voltage gain of 10k V/V and high slew rate of 90V/μs make the MAX408/428/448 ideal for analog amplification and high speed signal processing. 100MHz gain bandwidth and a ±0.1% settling time of 150ns make each amplifier ideal for fast data conversion systems.

±50mA output current capability allows the amplifiers to drive terminated transmission lines of 50Ω with amplitudes of 5V peak-to-peak.

Along with the high speed and output drive capability, a 35nA offset current and trimmable offset voltage make the MAX408/428/448 optimal for signal conditioning applications where accuracy must be maintained.

### Applications

- Video Amplifiers
- Test Equipment
- Waveform Generators
- Video Distribution
- Pulse Amplifiers

### Features

- ◆ Fast Settling Time: ±0.1% in 150ns *T-79-23*
- ◆ High Slew Rate: 90V/μs
- ◆ Large Gain Bandwidth: 100MHz
- ◆ Full Power Bandwidth: 4.8MHz at 6V p-p
- ◆ Ease of Use: Internally Compensated for  $A_{CL} \geq 3$  with 50° - 60° Phase Margin
- ◆ Large Output Current: ±50mA
- ◆ Low Supply Voltage Operation: ±4V
- ◆ Wide Input Voltage Range: Within 1.5V of  $V^+$  and 0.5V of  $V^-$
- ◆ Minimal Crosstalk: >90dB Separation (MAX428/448)
- ◆ Short Circuit Protection

### Ordering Information

PART	TEMP. RANGE	PACKAGE*
MAX408ACPA	0°C to +70°C	8 Lead Plastic DIP
MAX408ACJA	0°C to +70°C	8 Lead CERDIP
MAX408ACSA	0°C to +70°C	8 Lead Small Outline
MAX408ACTV	0°C to +70°C	8 Lead TO-99 Metal Can
MAX408CPA	0°C to +70°C	8 Lead Plastic DIP
MAX408CJA	0°C to +70°C	8 Lead CERDIP
MAX408CSA	0°C to +70°C	8 Lead Small Outline
MAX408CTV	0°C to +70°C	8 Lead TO-99 Metal Can
MAX408C/D	0°C to 70°C	Dice
MAX408MJA	-55°C to +125°C	8 Lead CERDIP
MAX408MTV	-55°C to +125°C	8 Lead TO-99 Metal Can

(Ordering Information continued on last page.)  
\*Contact factory for availability of 20 Lead LCC

### Pin Configurations

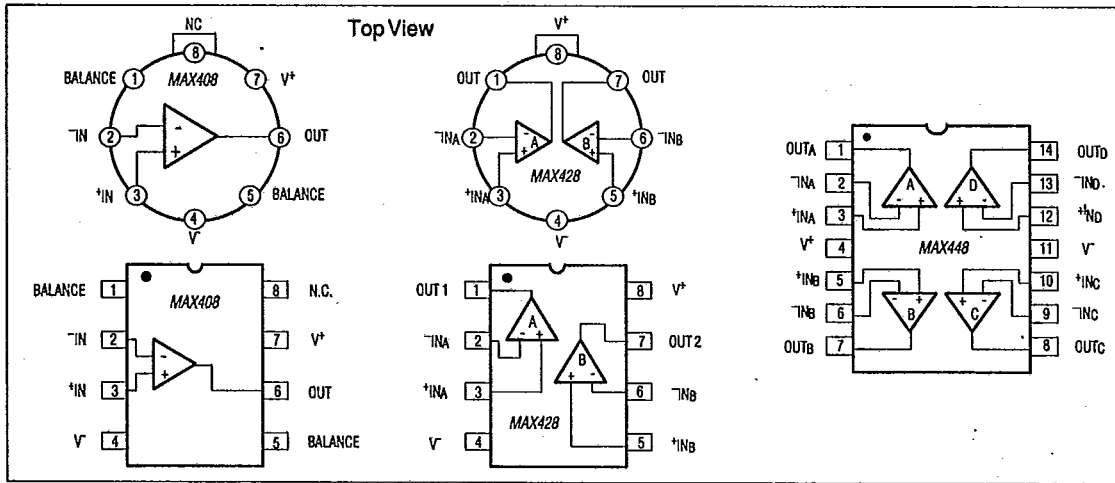

Maxim Integrated Products 4-19

MAXIM is a registered trademark of Maxim Integrated Products.

MAX408/428/448

4

T-79-23

MAX408/428/448

# Single/Dual/Quad High Speed, Fast Settling, High Output Current Operational Amplifier

## ABSOLUTE MAXIMUM RATINGS - MAX408

Supply Voltages	±6V
Differential Input Voltage	±9V
Common Mode Input Voltage	V <sub>SI</sub>   -0.5V
Power Dissipation (Note 1)	450mW
Output Short Circuit Current Duration (Note 2)	Indefinite

Operating Temperature Range:	
Commercial (MAX408AC, C)	0°C to +70°C
Military (MAX408M)	-55°C to +125°C
Storage Temperature Range	
	-65°C to +150°C
Lead Temperature (Soldering, 60 seconds)	
	300°C

**Note 1:** Power derating above T<sub>A</sub> = 70°C to be based on a maximum junction temperature of 150°C and the thermal resistance factors in the chart below

**Note 2:** Continuous short circuit protection is allowed for the case and ambient temperatures in the chart below.

PKG	θ <sub>Jc</sub> (°C/W)	θ <sub>JA</sub> (°C/W)	T <sub>C</sub> (°C)	T <sub>A</sub> (°C)
DIP, CERDIP	75	180	110	70
SOIC	115	180	95	70
TO-99	115	150	95	30

## ELECTRICAL CHARACTERISTICS - MAX408 (V<sub>S</sub> = ±5V, T<sub>A</sub> = 25°C unless otherwise noted.)

PARAMETER	SYMBOL	CONDITIONS	MAX408C		MAX408AC		MAX408M		UNITS
			MIN	TYP MAX	MIN	TYP MAX	MIN	TYP MAX	
Input Offset Voltage	V <sub>OS</sub>	T <sub>A</sub> = 25°C 0°C ≤ T <sub>A</sub> ≤ 70°C -55°C ≤ T <sub>A</sub> ≤ 125°C	5	12 8 16	3	6 5 10	3	6 6 12	mV
Average Offset Voltage Drift	ΔV <sub>OS</sub> /ΔT	0°C ≤ T <sub>A</sub> ≤ 70°C -55°C ≤ T <sub>A</sub> ≤ 125°C	20		20		15		μV/°C
Input Bias Current	I <sub>B</sub>		650	1100	650	1100	650	1100	nA
Input Offset Current	I <sub>OS</sub>	T <sub>A</sub> = 25°C 0°C ≤ T <sub>A</sub> ≤ 70°C -55°C ≤ T <sub>A</sub> ≤ 125°C	35	120 70 200	35	120 70 200	35	120 70 300	nA
Input Common Mode Range	V <sub>CM</sub>		+3 -4	+3.5 -4.5	+3 -4	+3.5 -4.5	+3 -4	+3.5 -4.5	V
Differential Input Resistance	R <sub>IND</sub>	(Note 1)	3	10	3	10	3	10	MΩ
Common Mode Input Resistance	R <sub>INC</sub>	(Note 1)	4	8	4	8	4	8	MΩ
Differential Input Capacitance	C <sub>IND</sub>		2		2		2		pF
Common Mode Input Capacitance	C <sub>INC</sub>		3		3		3		pF
Input Voltage Noise	e <sub>N</sub>	BW = 10Hz to 100kHz	12		12		12		μV <sub>RMS</sub>
Open Loop Voltage Gain	A <sub>V</sub>	V <sub>OUT</sub> = ±3V, R <sub>L</sub> = 2kΩ	2	5	5	10	5	10	V/mV
Output Voltage Swing	V <sub>OUT</sub>	R <sub>L</sub> = 2kΩ R <sub>L</sub> = 51Ω	±3.5 ±2.0	±2.4	±3.5 ±2.5	±2.7	±3.5 ±2.5	±2.7	V
Power Supply Current	I <sub>S</sub>	T <sub>A</sub> = 25°C	7	10	7	10	7	10	mA
Common Mode Rejection Ratio	CMRR	V <sub>CM</sub> = ±2V	60	70	60	70	60	70	dB
Power Supply Rejection Ratio	PSRR	ΔV <sub>PS</sub> = ±0.5V	60	66	60	66	60	66	dB
Slew Rate (Note 1)	SR	10-90% of Leading Edge (Figure 1)	60	90	60	90	60	90	V/μs
Settling Time	t <sub>S</sub>	To ±0.1% (±4mV) of Final Value (Figure 1) (Note 1)	150	200	150	200	150	200	ns
Gain Bandwidth Product	GBW		100		100		100		MHz

**Note 1:** Not tested, guaranteed by design.

T-79-23

# Single/Dual/Quad High Speed, Fast Settling, High Output Current Operational Amplifier

## ABSOLUTE MAXIMUM RATINGS - MAX428

Supply Voltages	±6V
Differential Input Voltage	±9V
Common Mode Input Voltage	$ V_{SI}  < 0.5V$
Power Dissipation (Note 1)	450mW
Output Short Circuit Current Duration (Note 2)	Indefinite

**Note 1:** Power derating above  $T_A = 70^\circ C$  to be based on a maximum junction temperature of  $150^\circ C$  and the following thermal resistance factors:

PKG	$\theta_{JC} (^{\circ}C/W)$	$\theta_{JA} (^{\circ}C/W)$
DIP	75	180
TO-99	115	150

Operating Temperature Range:

Commercial (MAX428AC, C)	$0^\circ C$ to $+70^\circ C$
Military (MAX428M)	$-55^\circ C$ to $+125^\circ C$

Storage Temperature Range  $-65^\circ C$  to  $+150^\circ C$   
 Lead Temperature (Soldering, 60 seconds)  $300^\circ C$

**Note 2:** Continuous short circuit protection is allowed on one amplifier per time up to the following case and ambient temperatures:

PKG	$T_C (^{\circ}C)$	$T_A (^{\circ}C)$
DIP	100	30
TO-99	75	(Note 3)

**Note 3:** Long duration shorts (>5 sec) will result in junction temperature exceeding  $150^\circ C$  which may result in part damage.

MAX408/428/448

## ELECTRICAL CHARACTERISTICS - MAX428 ( $V_S = \pm 5V$ , $T_A = 25^\circ C$ unless otherwise noted.)

PARAMETER	SYMBOL	CONDITIONS	MAX428C		MAX428AC		MAX428M		UNITS
			MIN	TYP MAX	MIN	TYP MAX	MIN	TYP MAX	
Input Offset Voltage	$V_{OS}$	$T_A = 25^\circ C$ $0^\circ C \leq T_A \leq 70^\circ C$ $-55^\circ C \leq T_A \leq 125^\circ C$	5	12	3	6	3	6	mV
Average Offset Voltage Drift	$\Delta V_{OS}/\Delta T$	$0^\circ C \leq T_A \leq 70^\circ C$ $-55^\circ C \leq T_A \leq 125^\circ C$	20		20		15		$\mu V/^\circ C$
Input Bias Current	$I_B$	$T_A = 25^\circ C$ $0^\circ C \leq T_A \leq 70^\circ C$ $-55^\circ C \leq T_A \leq 125^\circ C$	650	1100 1700	650	1100 1700	650	1100 1700 2200	mA
Input Offset Current	$I_{OS}$		35	120	35	120	35	120	nA
Input Common Mode Range	$V_{CM}$		+3 -4	+3.5 -4.5	+3 -4	+3.5 -4.5	+3 -4	+3.5 -4.5	V
Differential Input Resistance	$R_{IND}$	(Note 1)	3	10	3	10	3	10	$M\Omega$
Common Mode Input Resistance	$R_{INC}$	(Note 1)	4	8	4	8	4	8	$M\Omega$
Differential Input Capacitance	$C_{IND}$		2		2		2		pF
Common Mode Input Capacitance	$C_{INC}$		3		3		3		pF
Input Voltage Noise	$e_N$	$BW = 10Hz$ to $100kHz$	12		12		12		$\mu V_{RMS}$
Open Loop Voltage Gain	$A_V$	$V_{OUT} = \pm 3V$ , $R_L = 2k\Omega$	2	5	5	10	5	10	V/mV
Output Voltage Swing	$V_{OUT}$	$R_L = 2k\Omega$ $R_L = 51\Omega$	$\pm 3.5$ $\pm 2.0$	$\pm 2.4$	$\pm 3.5$ $\pm 2.5$	$\pm 2.7$	$\pm 3.5$ $\pm 2.5$	$\pm 2.7$	V
Power Supply Current	$I_S$	$T_A = 25^\circ C$	15 20		15 20		15 20		mA
Common Mode Rejection Ratio	CMRR	$V_{CM} = \pm 2V$	60	70	60	70	60	70	dB
Power Supply Rejection Ratio	PSRR	$\Delta V_{PS} = \pm 0.5V$	60	66	60	66	60	66	dB
Slew Rate (Note 1)	SR	10-90% of Leading Edge (Figure 1)	60	90	60	90	60	90	V/ $\mu s$
Settling Time	$t_S$	To $\pm 0.1\%$ ( $\pm 4mV$ ) of Final Value (Figure 1) (Note 1)	150	200	150	200	150	200	ns
Gain Bandwidth Product	GBW		100		100		100		MHz

**Note 1:** Not tested, guaranteed by design.



4

T-79-23

# Single/Dual/Quad High Speed, Fast Settling, High Output Current Operational Amplifier

MAX408/428/448

## ABSOLUTE MAXIMUM RATINGS - MAX448

Supply Voltages ..... ±6V  
 Differential Input Voltage ..... ±9V  
 Common Mode Input Voltage ..... |V<sub>SI</sub>| ≤ 0.5V  
 Power Dissipation (Note 1) ..... 550mW  
 Output Short Circuit Current Duration (Note 2) ..... Indefinite

Operating Temperature Range:  
 Commercial (MAX448AC, C) ..... 0°C to +70°C  
 Military (MAX448M) ..... -55°C to +125°C  
 Storage Temperature Range ..... -65°C to +150°C  
 Lead Temperature (Soldering, 60 seconds) ..... 300°C

**Note 1:** Power derating above T<sub>A</sub> = 70°C to be based on a maximum junction temperature of 150°C and the thermal resistance factors of θ<sub>JC</sub> = 75°C/W and θ<sub>JA</sub> = 150°C/W.

**Note 2:** Continuous short circuit protection is allowed on one amplifier per time up to case temperatures of 85°C and ambient temperatures of 30°C.

## ELECTRICAL CHARACTERISTICS - MAX448 (V<sub>S</sub> = ±5V, T<sub>A</sub> = 25°C unless otherwise noted.)

PARAMETER	SYMBOL	CONDITIONS	MAX448C		MAX448AC		MAX448M		UNITS
			MIN	TYP	MAX	MIN	TYP	MAX	
Input Offset Voltage	V <sub>OS</sub>	T <sub>A</sub> = 25°C 0°C ≤ T <sub>A</sub> ≤ 70°C -55°C ≤ T <sub>A</sub> ≤ 125°C	5	12	3	6	3	6	mV
			8	16	5	10	6	12	
Average Offset Voltage Drift	ΔV <sub>OS</sub> /ΔT	0°C ≤ T <sub>A</sub> ≤ 70°C -55°C ≤ T <sub>A</sub> ≤ 125°C	20		20		15		μV/°C
Input Bias Current	I <sub>B</sub>	T <sub>A</sub> = 25°C 0°C ≤ T <sub>A</sub> ≤ 70°C -55°C ≤ T <sub>A</sub> ≤ 125°C	650	1100	650	1100	650	1100	nA
				1700		1700		2200	
Input Offset Current	I <sub>OS</sub>		35	120	35	120	35	120	nA
Input Common Mode Range	V <sub>CM</sub>		+3 -4	+3.5 -4.5	+3 -4	+3.5 -4.5	+3 -4	+3.5 -4.5	V
Differential Input Resistance	R <sub>IND</sub>	(Note 1)	3	10	3	10	3	10	MΩ
Common Mode Input Resistance	R <sub>INC</sub>	(Note 1)	4	8	4	8	4	8	MΩ
Differential Input Capacitance	C <sub>IND</sub>		2				2		pF
Common Mode Input Capacitance	C <sub>INC</sub>		3		3		3		pF
Input Voltage Noise	e <sub>N</sub>	BW = 10Hz to 100kHz	12		12		12		μV <sub>RMS</sub>
Open Loop Voltage Gain	A <sub>V</sub>	V <sub>OUT</sub> = ±3V, R <sub>L</sub> = 2kΩ	2	5	4	10	4	10	V/mV
Output Voltage Swing	V <sub>OUT</sub>	R <sub>L</sub> = 2kΩ R <sub>L</sub> = 51Ω	±3.5 ±2.0	±2.4	±3.5 ±2.5	±2.7	±3.5 ±2.5	±2.7	V
Power Supply Current (All four amplifiers)	I <sub>S</sub>	T <sub>A</sub> = 25°C	30	40	30	40	30	40	mA
Power Supply Rejection Ratio	PSRR	ΔV <sub>PS</sub> = ±0.5V	60	66	60	66	60	66	dB
Common Mode Rejection Ratio	CMRR	V <sub>CM</sub> = ±2V	60	70	60	70	60	70	dB
Slew Rate (Note 1)	SR	10-90% of Leading Edge (Figure 1)	60	90	60	90	60	90	V/μs
Settling Time	t <sub>S</sub>	To ±0.1% (±4mV) of Final Value (Figure 1) (Note 1)	150	200	150	200	150	200	ns
Gain Bandwidth Product	GBW		100		100		100		MHz

**Note 1:** Not tested, guaranteed by design.

T-79-23

# Single/Dual/Quad High Speed, Fast Settling, High Output Current Operational Amplifier

AC CHARACTERISTICS - MAX408/428/448 ( $V_S = \pm 5V$ ,  $T_A = 25^\circ C$  unless otherwise specified)

PARAMETER	SYMBOL	CONDITIONS	MAX4XXC			MAX4XXAC			MAX4XXM			UNITS
			MIN	TYP	MAX	MIN	TYP	MAX	MIN	TYP	MAX	
Small Signal Rise/Fall Time	$t_{r/f}$	$e_o = \pm 100mV$ 10-90% (Figure 1)	7			7			7			ns
Full Power Bandwidth	$BW_{FP}$	$R_L = 2k\Omega$ , $C_L = 50pF$ $V_{OUT} = 6V_{p-p}$	4.8			4.8			4.8			MHz
Amp-Amp Crosstalk (MAX428/448)		Input Referenced $f = 10kHz$	-96			-96			-96			dB

MAX408/428/448

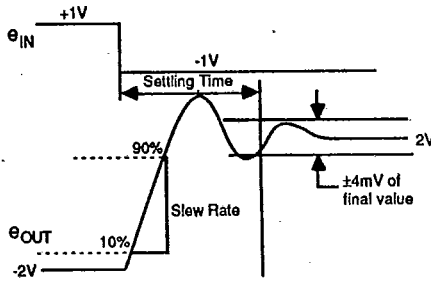
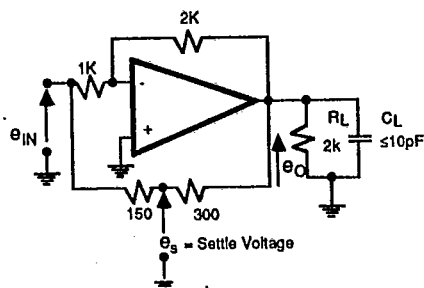

Note that to properly measure  $e_s$ , amplifier and settle resistor ratios should be matched to 0.5% and probe capacitance  $\leq 35pF$

Figure 1A. Settling Time and Slew Rate Test Circuit

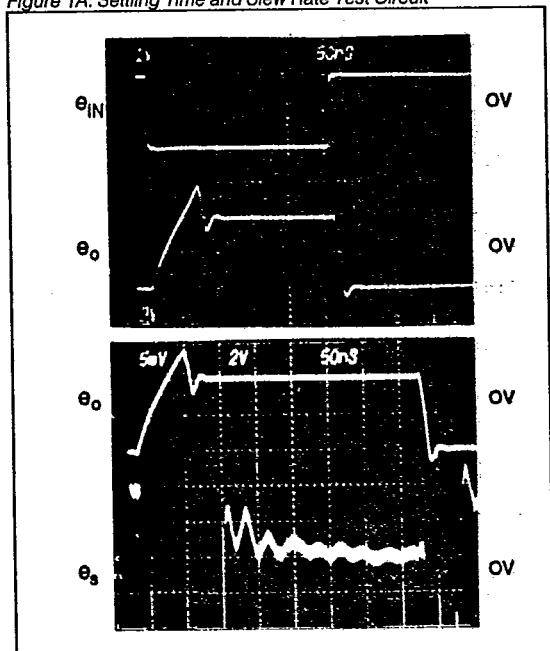

Figure 1B. Large Signal Response

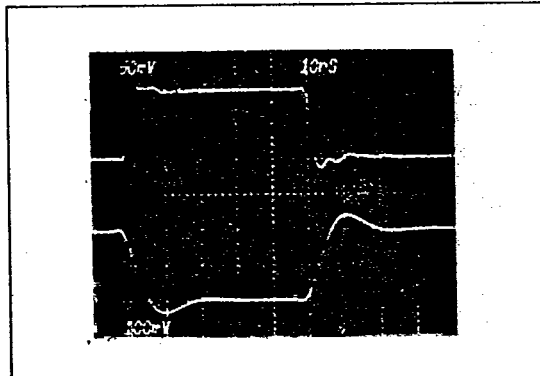

Figure 1C. Small Signal Response

4

T-79-23

# Single/Dual/Quad High Speed, Fast Settling, High Output Current Operational Amplifier

MAX408/428/448

## Typical Operating Characteristics

( $V_S = \pm 5V$ ,  $T_A = 25^\circ C$  unless otherwise stated and apply for each individual op amp where applicable)

INPUT BIAS CURRENT vs TEMPERATURE

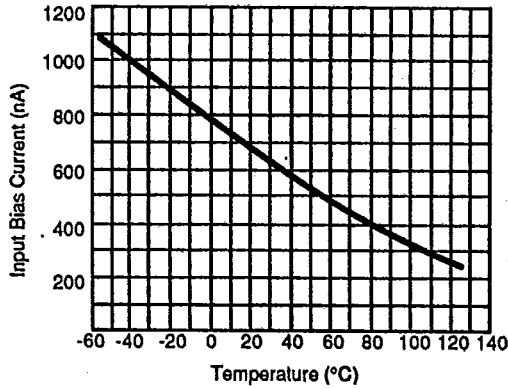

NORMALIZED OPEN LOOP GAIN vs TEMPERATURE

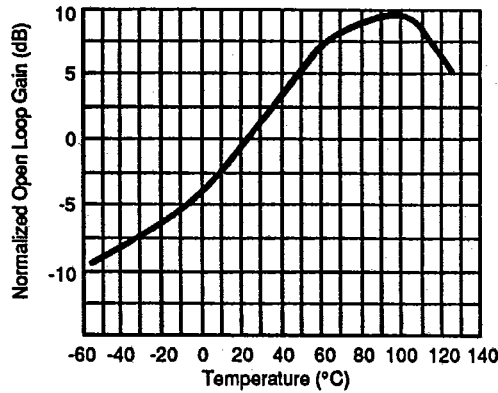

SUPPLY CURRENT vs SUPPLY VOLTAGE

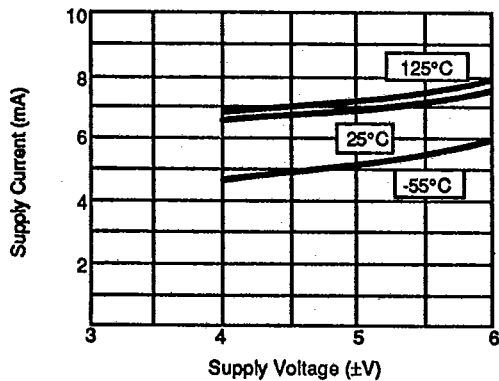

OPEN LOOP GAIN vs SUPPLY VOLTAGE

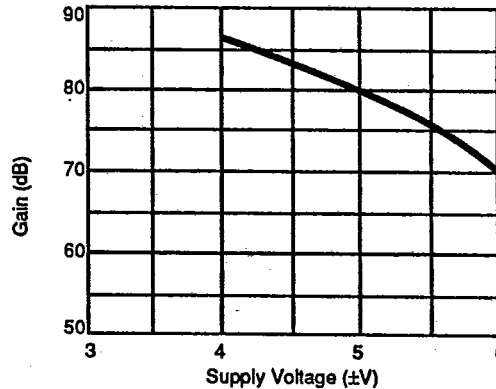

INPUT OFFSET CURRENT vs TEMPERATURE

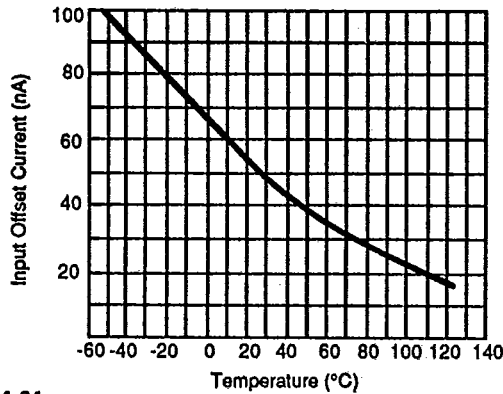

AMPLIFIER/AMPLIFIER CROSSTALK vs FREQUENCY (MAX428/448)

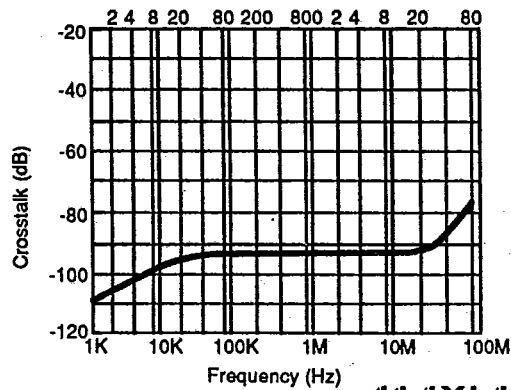

T-79-23

# Single/Dual/Quad High Speed, Fast Settling, High Output Current Operational Amplifier

## Typical Operating Characteristics (continued)

MAX408/428/448

MAXIMUM OUTPUT VOLTAGE SWING vs LOAD RESISTANCE

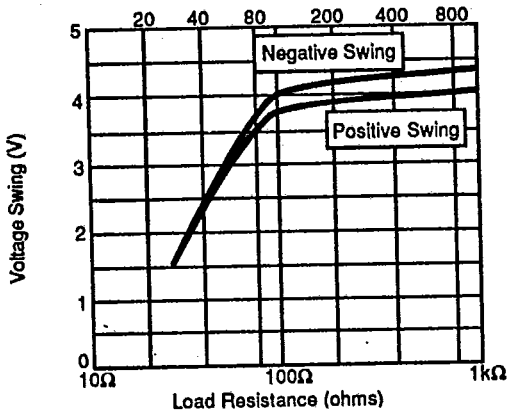

MAXIMUM OUTPUT VOLTAGE SWING vs TEMPERATURE

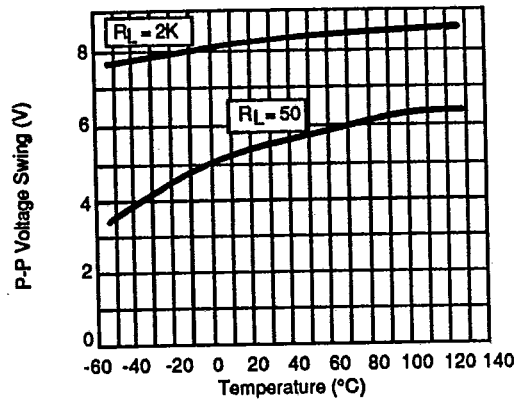

SHORT CIRCUIT OUTPUT CURRENT vs TEMPERATURE

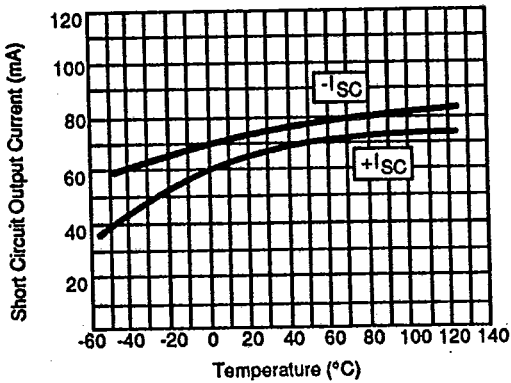

EQUIVALENT INPUT NOISE vs BANDWIDTH

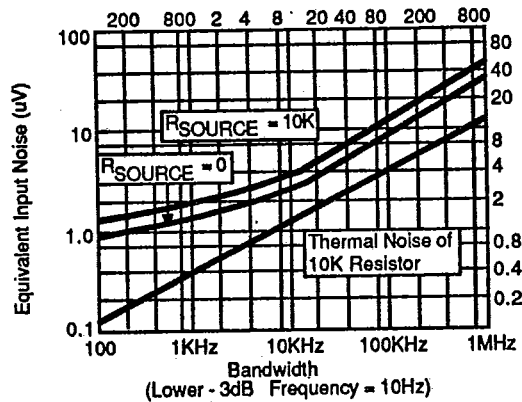

4

T-79-23

# Single/Dual/Quad High-Speed, Fast-Settling, High Output Current Operational Amplifier

MAX408/428/448

## Typical Operating Characteristics (continued)

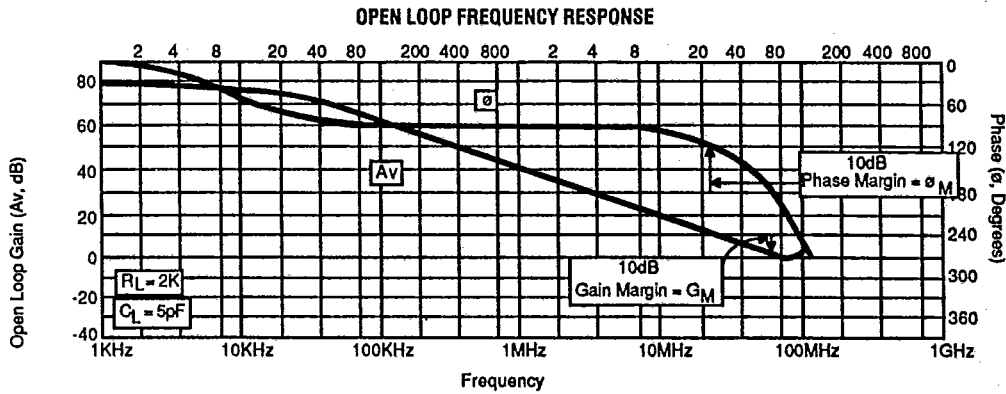

OPEN LOOP FREQ. RESPONSE,  $R_L = 50\Omega$ ,  $C_L = 50pF$

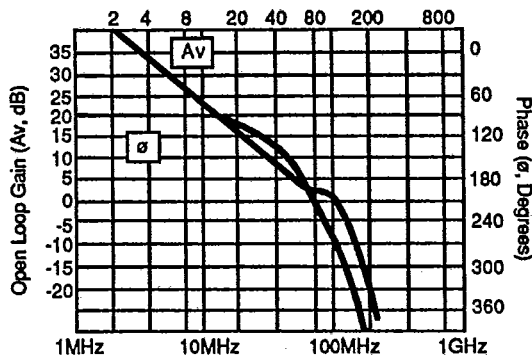

OPEN LOOP FREQ. RESPONSE,  $R_L = 2K\Omega$ ,  $C_L = 50pF$

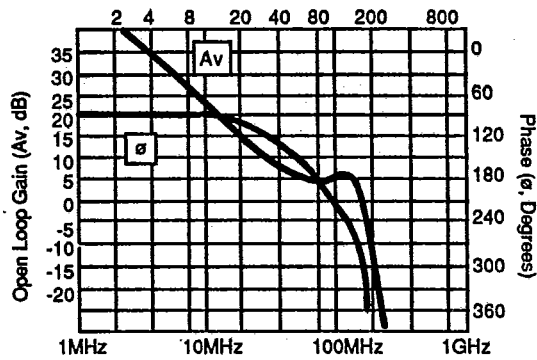

10dB PHASE MARGIN AND 10dB FREQ. vs TEMP.

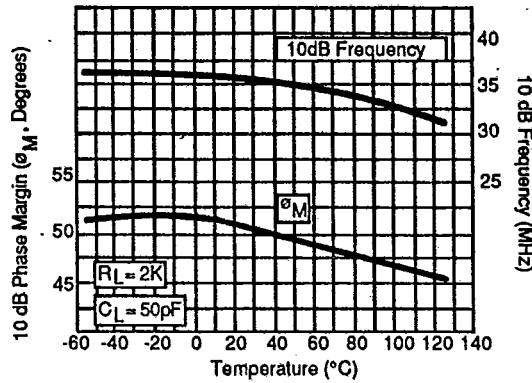

GAIN MARGIN AND 180 DEGREE FREQ. vs TEMP.  $A_v = 10dB$

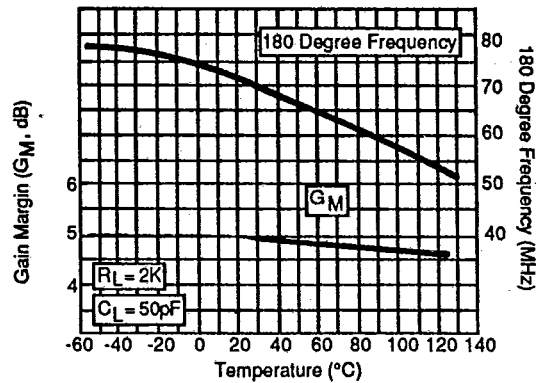



T-79-23

# Single/Dual/Quad High-Speed, Fast-Settling, High Output Current Operational Amplifier

## Application Information

### AC Characteristics

The 35MHz 10dB crossover point of the MAX408/428/448 is achieved without feed forward compensation, a technique which can produce long tails in the recovery characteristic. The single pole rolloff follows the classic 20dB/decade slope to frequencies approaching 50MHz. The 10dB (3.2V/V) phase margin of 50°, even with a capacitive load of 50pF, gives stable and predictable performance down to non-inverting gain configurations of approximately 3V/V (inverting gains of -2V/V). At frequencies beyond 50MHz, the 20dB/decade slope is disturbed by an output stage zero, the damping factor of which is dependent upon the  $R_L$ ,  $C_L$  load combination. This results in loss of gain margin (gain at loop phase = 360°) at frequencies of 70 to 100MHz which at a gain margin of 5dB ( $R_L = 2K$ ,  $C_L = 5pF$ ) results in a peak in the gain of 3 amplifier configurations as shown in Figures 3 and 4.

Figure 3 shows a blow up of the open loop characteristics in the 10MHz to 200MHz frequency range, as well as the corresponding closed loop characteristics for a gain of 3 non-inverting amplifier at similar load conditions. It should be noted that the open loop characteristic does not show the additional phase shift covered by the input capacitance pole. This is why the closed loop peaking at 30 to 40MHz is greater than what would be expected from the 50 to 60 degrees of phase margin indicated by the open loop characteristics. Corresponding small signal step response characteristics show well-behaved pulse waveforms with 16-33% overshoot.

The input capacitive pole can be neutralized by adding a feedback capacitor to  $R_2$ . The value of capacitance is selected according to  $R_1 C_{IN} = R_2 C_{FB}$ , where  $C_{IN}$  is the

sum of the common mode and differential input capacitance = 5pF. For  $R_2 = 2R_1$ ,  $C_{FB} = C_{IN}/2 \approx 2.5pF$ .

Figure 4 shows the results of this feedback capacitor addition. Neutralizing the input capacitance demonstrates the peaking that can result from the loss of gain margin at 70 to 100MHz. As the load time constant ( $R_L C_L$ ) increases the peaking gets progressively worse ≈6dB at  $R_L = 2K$ ,  $C_L = 50pF$ . The step response waveforms are as expected with a very strong 88MHz ring being exhibited at  $R_L = 2K$ ,  $C_L = 50pF$  and no overshoot at  $R_L = 50\Omega$ ,  $C_L = 5pF$ .

### Layout Considerations

As with any high-speed wideband amplifier, certain layout considerations are necessary to ensure stable operation. All connections to the amplifier should remain as short as possible, and the power supplies bypassed with 0.1μF capacitors to signal ground. It is suggested that a ground plane be considered as the best method for ensuring stability because it minimizes stray inductance and unwanted coupling in the ground signal paths.

To minimize capacitive effects, resistor values should be kept as small as possible, consistent with the application.

### MAX408 Offset Voltage Nulling

The configuration of Figure 2 will give a typical  $V_{OS}$  nulling range of ±15mV. If a smaller adjustment range is desired, resistor values  $R_1$  and  $R_2$  can be increased accordingly. For example, at  $R_1 = 3.6k\Omega$ , the adjustment range is ±5mV. Since pins 1 and 5 are not part of the signal path, AC characteristics are left undisturbed.

MAX408/428/448

4

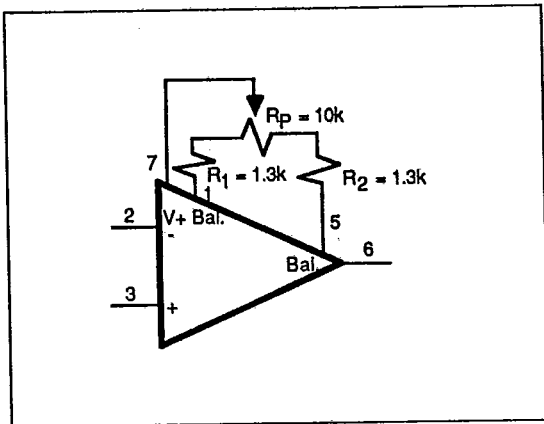
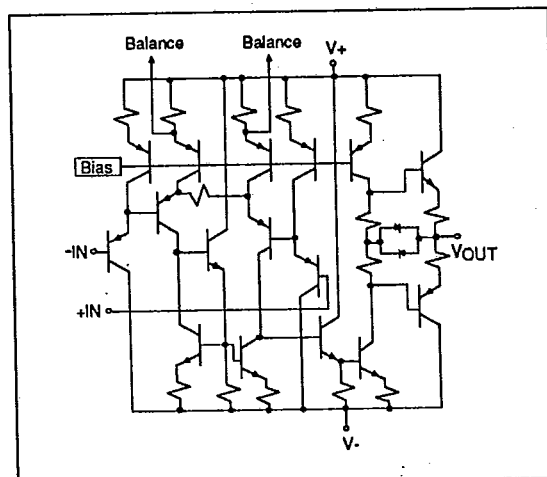

Figure 2.  $V_{OS}$  Nulling Method for MAX408



Simplified Schematic. For MAX428/448 omit balance pins.

T-79-23

# Single/Dual/Quad High-Speed, Fast-Settling, High Output Current Operational Amplifier

MAX408/428/448

OPEN LOOP FREQUENCY RESPONSE

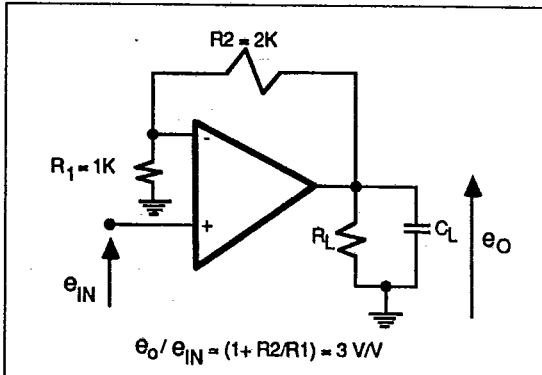
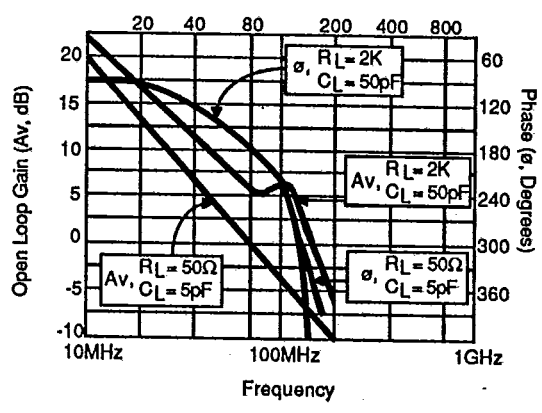

CLOSED LOOP FREQUENCY RESPONSE

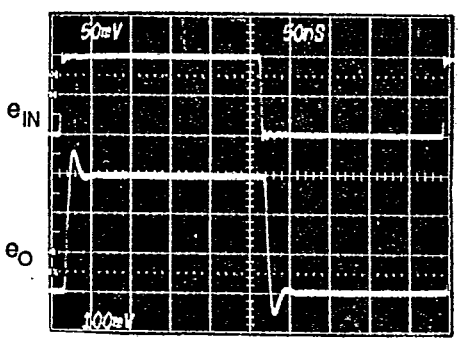
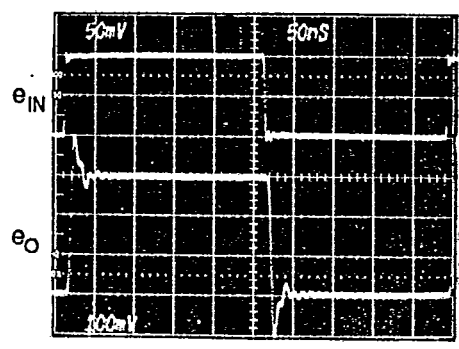
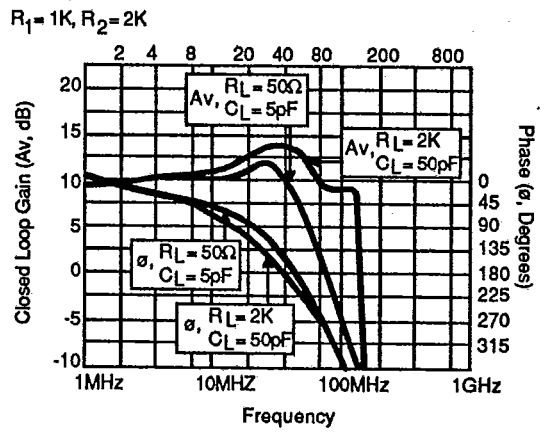

Small Signal Step Response

Figure 3. Frequency and Time Domain Response Characteristics, Av = 3

T-79-23

# Single/Dual/Quad High-Speed, Fast-Settling, High Output Current Operational Amplifier

MAX408/428/448

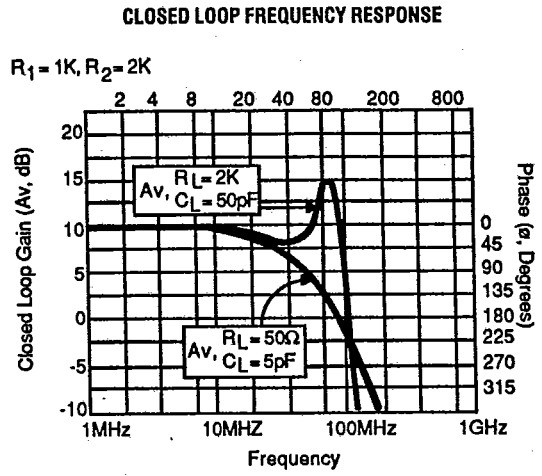
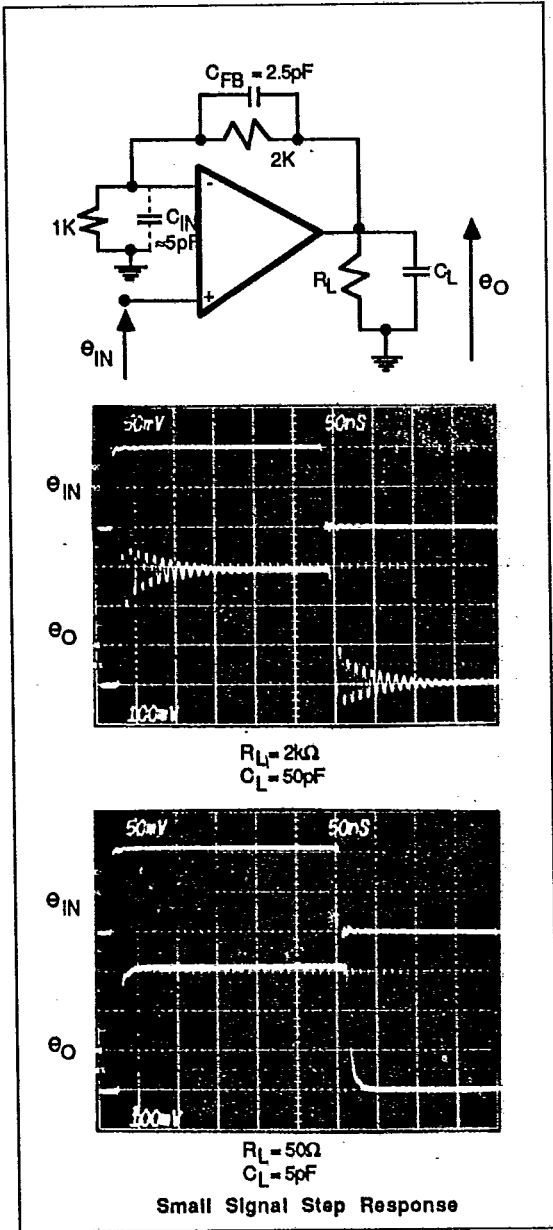

4

Figure 4. Response Characteristics with Input Pole Cancellation, Av = 3

T-79-23

**Single/Dual/Quad High-Speed, Fast-Settling,  
High Output Current Operational Amplifier****Ordering Information (continued)**

MAX408/428/448

PART	TEMP. RANGE	PACKAGE*
MAX428ACPA	0°C to +70°C	8 Lead Plastic DIP
MAX428ACJA	0°C to +70°C	8 Lead Cerdip
MAX428ACSA	0°C to +70°C	8 Lead Small Outline
MAX428ACTV	0°C to +70°C	8 Lead TO-99 Metal Can
MAX428CPA	0°C to +70°C	8 Lead Plastic DIP
MAX428CJA	0°C to +70°C	8 Lead Cerdip
MAX428CSA	0°C to +70°C	8 Lead Small Outline
MAX428CTV	0°C to +70°C	8 Lead TO-99 Metal Can
MAX428C/D	0°C to +70°C	Dice
MAX428MJA	-55°C to +125°C	8 Lead Cerdip
MAX428MTV	-55°C to +125°C	8 Lead TO-99 Metal Can
MAX448ACPD	0°C to +70°C	14 Lead Plastic DIP
MAX448ACJD	0°C to +70°C	14 Lead Cerdip
MAX448ACSD	0°C to +70°C	14 Lead Small Outline
MAX448CPD	0°C to +70°C	14 Lead Plastic DIP
MAX448CJD	0°C to +70°C	14 Lead Cerdip
MAX448CSD	0°C to +70°C	14 Lead Small Outline
MAX448C/D	0°C to +70°C	Dice
MAX448MJD	-55°C to +125°C	14 Lead Cerdip

\*Contact factory for availability of 20 Lead LCC

Maxim cannot assume responsibility for use of any circuitry other than circuitry entirely embodied in a Maxim product. No circuit patent licenses are implied. Maxim reserves the right to change the circuitry and specifications without notice at any time.