

# GPS/GNSS Low-Noise Amplifier

## General Description

The MAX2659 high-gain, low-noise amplifier (LNA) is designed for GPS, Galileo, and GLONASS applications. Designed in Maxim's advanced SiGe process, the device achieves a 20.5dB gain and an ultra-low-noise figure of 0.8dB while maximizing the input-referred 1dB compression point and the 3rd-order intercept point at -12dBm and -5dBm, respectively.

The MAX2659 operates from a +1.6V to +3.6V single supply and consumes only 4.1mA. The shutdown feature in the device reduces the supply current to be less than 1 $\mu$ A. The MAX2659 is available in a very small, lead-free, RoHS-compliant, 1.5mm x 1.0mm x 0.75mm, 6-pin  $\mu$ DFN package.

## Applications

Automotive Navigation  
Location-Enabled Mobile Devices  
Telematics (Asset Tracking and Management)  
Personal Navigation Device (PND)  
Cellular Phones with GPS  
Notebook PC/Ultra-Mobile PC  
Recreational, Marine Navigation  
Avionics

## Features

- ◆ High-Power Gain: 20.5dB
- ◆ Ultra-Low-Noise Figure: 0.8dB
- ◆ Integrated 50 $\Omega$  Output Matching Circuit
- ◆ Low Supply Current: 4.1mA
- ◆ Wide Supply Voltage Range: 1.6V to 3.6V
- ◆ Low Bill of Materials
- ◆ Small Footprint: 1.5mm x 1.0mm
- ◆ Thin Profile: 0.75mm
- ◆ Lead-Free and RoHS-Compliant Package

## Ordering Information

| PART          | TEMP RANGE     | PIN-PACKAGE |
|---------------|----------------|-------------|
| MAX2659ELT+   | -40°C to +85°C | 6 $\mu$ DFN |
| MAX2659ELT/V+ | -40°C to +85°C | 6 $\mu$ DFN |

+ Denotes a lead(Pb)-free/RoHS-compliant package.  
/V denotes an automotive qualified part.

## Pin Configuration/Functional Diagram/Typical Application Circuit

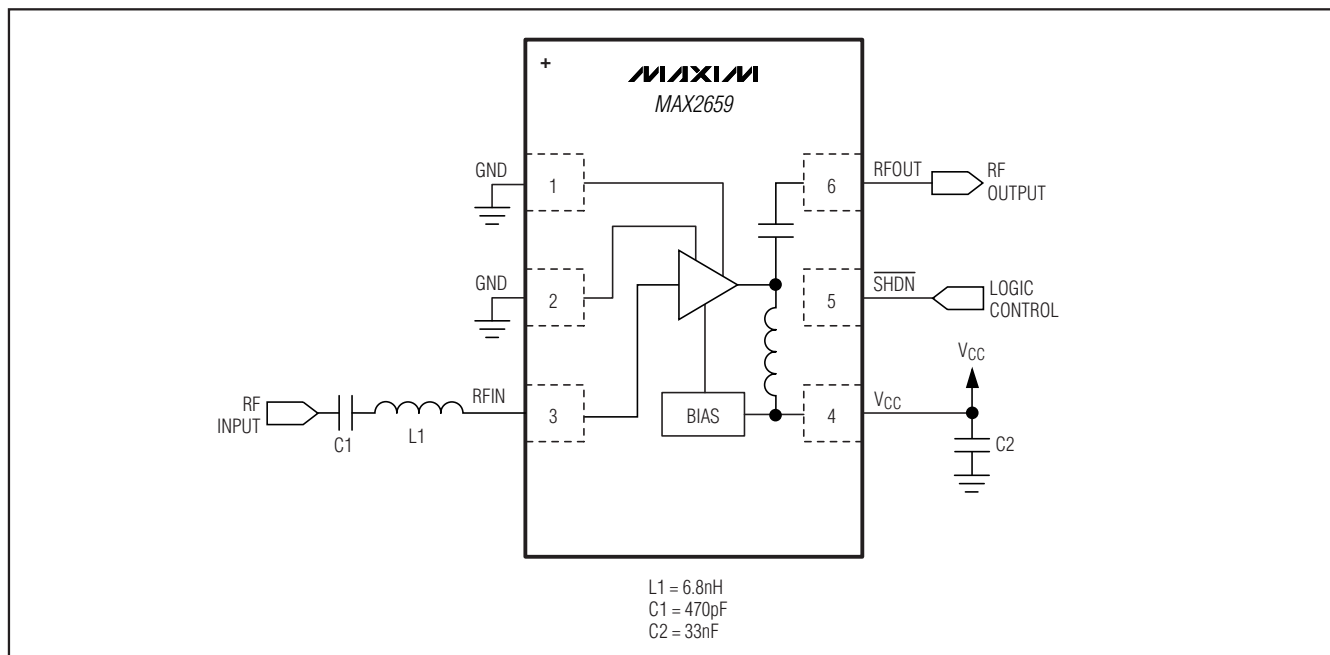

# GPS/GNSS Low-Noise Amplifier

## ABSOLUTE MAXIMUM RATINGS

V<sub>CC</sub> to GND .....-0.3V to +4.2V  
 Other Pins to GND.....-0.3V to + Operating V<sub>CC</sub> + 0.3V  
 Maximum RF Input Power .....+10dBm  
 Continuous Power Dissipation (T<sub>A</sub> = +70°C)  
 6-Pin µDFN (derates 2.1mW/°C above +70°C).....167mW

Operating Temperature Range .....-40°C to +85°C  
 Junction Temperature.....+150°C  
 Storage Temperature Range .....-65°C to +160°C  
 Lead Temperature (soldering, 10s).....+260°C  
 Soldering Temperature (reflow).....+260°C

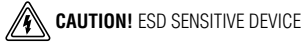

Stresses beyond those listed under "Absolute Maximum Ratings" may cause permanent damage to the device. These are stress ratings only, and functional operation of the device at these or any other conditions beyond those indicated in the operational sections of the specifications is not implied. Exposure to absolute maximum rating conditions for extended periods may affect device reliability.

## DC ELECTRICAL CHARACTERISTICS

(MAX2659 EV kit; V<sub>CC</sub> = 1.6V to 3.6V, T<sub>A</sub> = -40°C to +85°C, no RF signals are applied. Typical values are at V<sub>CC</sub> = 2.85V and T<sub>A</sub> = +25°C, unless otherwise noted.) (Note 1)

| PARAMETER                | CONDITIONS                | MIN | TYP  | MAX | UNITS |
|--------------------------|---------------------------|-----|------|-----|-------|
| Supply Voltage           |                           | 1.6 | 2.85 | 3.6 | V     |
| Supply Current           | SHDN = high               |     | 4.1  | 5.6 | mA    |
|                          | Shutdown mode, SHDN = low |     |      | 1   | µA    |
| Digital Input-Logic High |                           | 1.1 |      |     | V     |
| Digital Input-Logic Low  |                           |     |      | 0.4 | V     |
| Digital Input Current    |                           |     |      | 1   | µA    |
| RFIN DC Voltage          | SHDN = high               |     | 0.83 |     | V     |

## AC ELECTRICAL CHARACTERISTICS

(MAX2659 EV kit; V<sub>CC</sub> = 1.6V to 3.6V, T<sub>A</sub> = -40°C to +85°C, f<sub>RFIN</sub> = 1575.42MHz. Typical values are at V<sub>CC</sub> = 2.85V and T<sub>A</sub> = +25°C, unless otherwise noted.) (Note 1)

| PARAMETER                       | CONDITIONS              | MIN  | TYP     | MAX | UNITS |
|---------------------------------|-------------------------|------|---------|-----|-------|
| RF Frequency                    | L1 band                 |      | 1575.42 |     | MHz   |
| Power Gain                      | V <sub>CC</sub> = 2.85V | 17   | 20.5    |     | dB    |
|                                 | V <sub>CC</sub> = 1.6V  | 16.5 | 20.5    |     |       |
| Noise Figure                    | (Note 2)                |      | 0.8     |     | dB    |
| 3rd-Order Input Intercept Point | (Note 3)                |      | -5      |     | dBm   |
| Input 1dB Compression point     | (Note 4)                |      | -12     |     | dBm   |
| Input Return Loss               | (Note 2)                | 10   | 15      |     | dB    |
| Output Return Loss              | (Note 2)                | 10   | 25      |     | dB    |
| Reverse Isolation               | (Note 2)                |      | 32      |     | dB    |

**Note 1:** Min and Max limits guaranteed by test at T<sub>A</sub> = +25°C and guaranteed by design and characterization at T<sub>A</sub> = -40°C and T<sub>A</sub> = +85°C.

**Note 2:** Guaranteed by design and characterization.

**Note 3:** Measured with the two tones located at 5MHz and 10MHz offset from the center of the GPS band with -40dBm/tone.

**Note 4:** Measured with a tone located at 5MHz offset from the center of the GPS band.

# GPS/GNSS Low-Noise Amplifier

MAX2659

## Typical Operating Characteristics

(MAX2659 EV kit; Typical values are at  $V_{CC} = 2.85V$ ,  $T_A = +25^\circ C$ , and  $f_{RFIN} = 1575.42MHz$ , unless otherwise noted.)

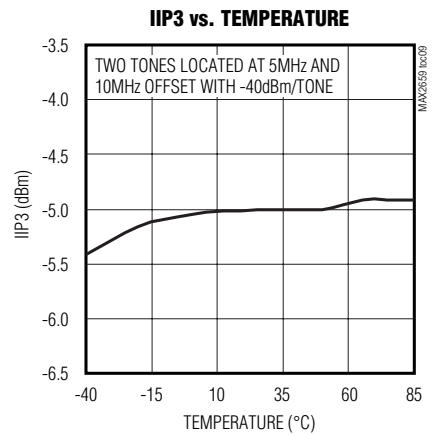
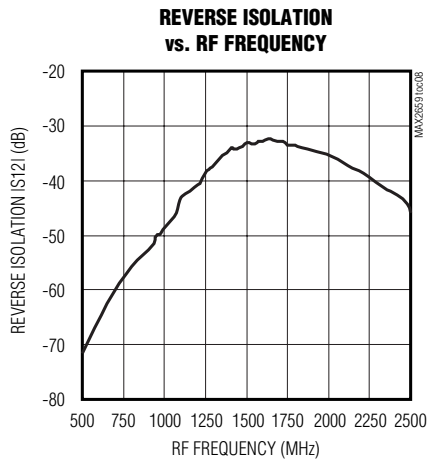
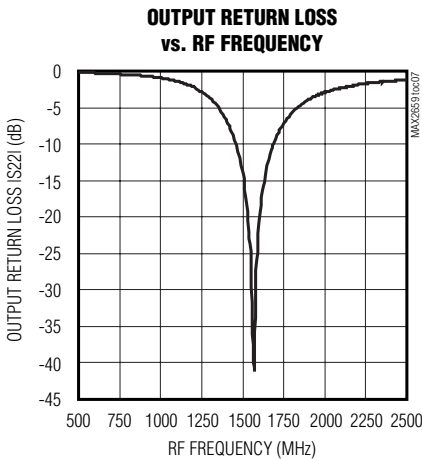
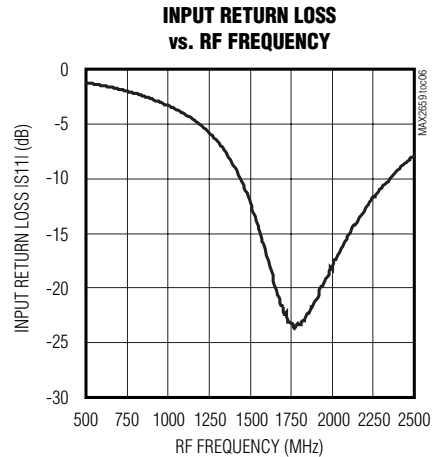
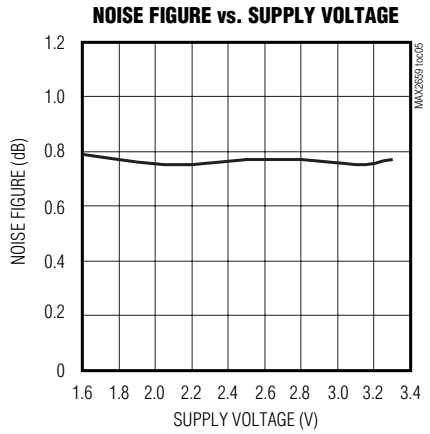
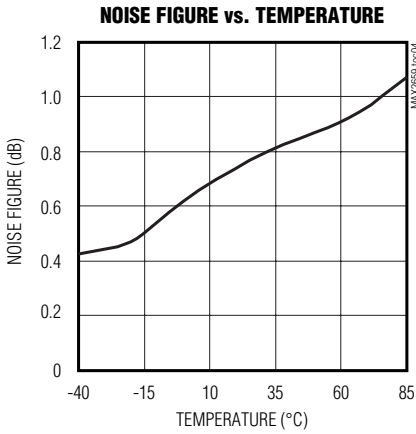
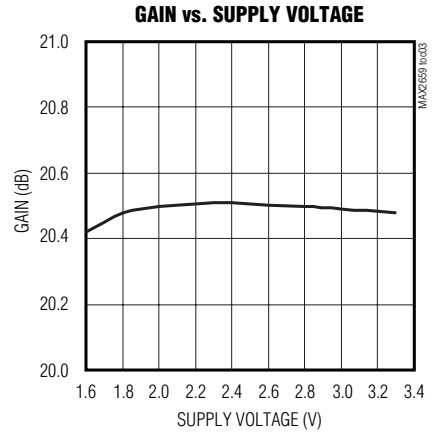
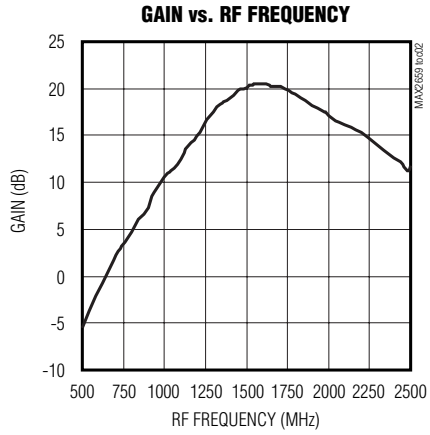
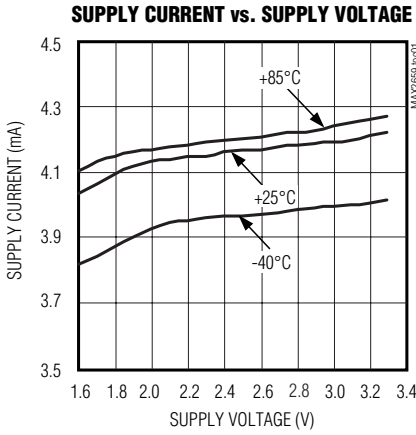

# GPS/GNSS Low-Noise Amplifier

## Typical Operating Characteristics (continued)

(MAX2659 EV kit; Typical values are at  $V_{CC} = 2.85V$ ,  $T_A = +25^\circ C$ , and  $f_{RFIN} = 1575.42MHz$ , unless otherwise noted.)

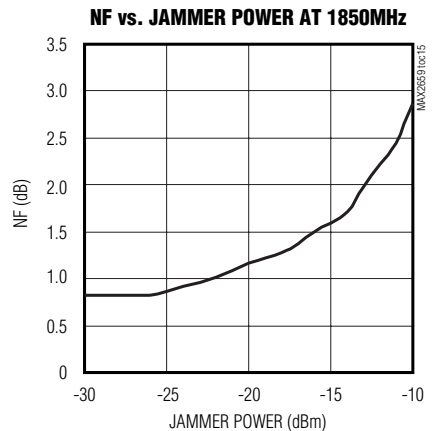
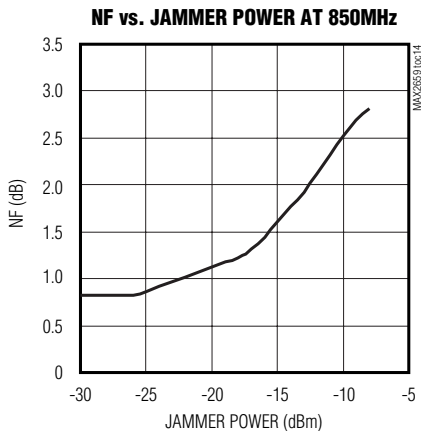
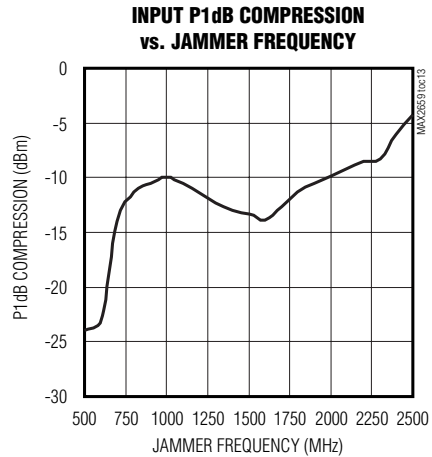
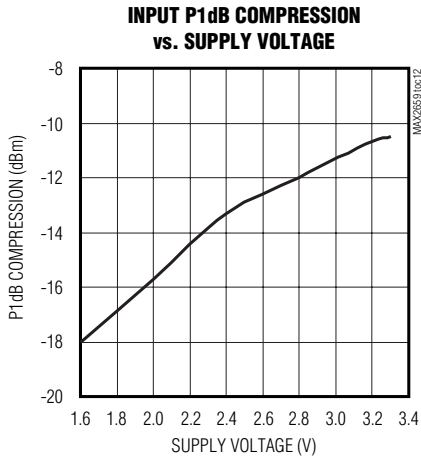
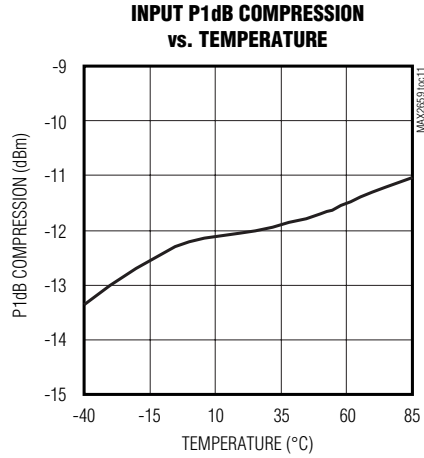
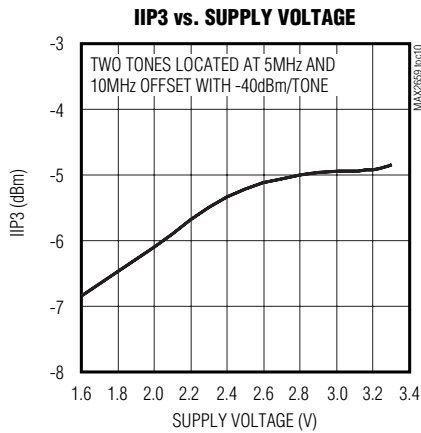

# GPS/GNSS Low-Noise Amplifier

MAX2659

## Pin Description

| PIN  | NAME            | FUNCTION  |
|------|-----------------|---|
| 1, 2 | GND             | Ground. Connect to the PCB ground plane.  |
| 3    | RFIN            | RF Input. Requires a DC-blocking capacitor and external matching components.                      |
| 4    | V <sub>CC</sub> | Supply Voltage. Bypass to ground with a 33nF capacitor as close as possible to the IC.            |
| 5    | SHDN            | Shutdown Input. A logic-low disables the device.  |
| 6    | RFOUT           | RF Output. RFOUT is internally matched to 50Ω and incorporates an internal DC-blocking capacitor. |

## Detailed Description

The MAX2659 is an LNA designed for GPS L1, GALILEO, and GLONASS applications. The device features a power-shutdown control mode to eliminate the need for an external supply switch. The device achieves a 20.5dB gain and an ultra-low-noise figure of 0.8dB. The MAX2659 consumes approximately 4.1mA while providing a IP<sub>1dB</sub> of -12dBm and an IIP<sub>3</sub> of -5dBm.

### Input and Output Matching

The MAX2659 requires an off-chip input matching. Only a 6.8nH inductor in series with a DC-blocking capacitor is needed to form the input matching circuit. The *Typical Application Circuit* diagram shows the recommended input-matching network. These values are optimized for the best simultaneous gain, noise figure, and return loss performance. Table 1 lists typical device S<sub>11</sub> values. The MAX2659 integrates an on-chip output matching to 50Ω at the output, eliminating the need for external matching components.

**Table 1. Typical S<sub>11</sub> Values**

| FREQUENCY (MHz) | REAL S <sub>11</sub> | IMAGINARY S <sub>11</sub> |
|-----------------|----------------------|---------------------------|
| 1000            | -0.58                | -j0.52                    |
| 1100            | -0.68                | -j0.356                   |
| 1200            | -0.74                | -j0.16                    |
| 1300            | -0.74                | j0.036                    |
| 1400            | -0.676               | j0.22                     |
| 1500            | -0.56                | j0.36                     |
| 1575            | -0.47                | j0.415                    |
| 1600            | -0.44                | j0.43                     |
| 1700            | -0.36                | j0.467                    |
| 1800            | -0.3                 | j0.51                     |
| 1900            | -0.228               | j0.567                    |
| 2000            | -0.14                | j0.622                    |

## Shutdown

The MAX2659 includes a shutdown feature to turn off the entire chip. Apply a logic high to SHDN pin to place the part in the active mode and a logic low to place the part in the shutdown mode.

## Applications Information

A properly designed PC board (PCB) is essential to any RF microwave circuit. Use controlled-impedance lines on all high-frequency inputs and outputs. Bypass V<sub>CC</sub> with decoupling capacitors located close to the device. For long V<sub>CC</sub> lines, it may be necessary to add decoupling capacitors. Locate these additional capacitors further away from the device package. Proper grounding of the GND pins is essential. If the PCB uses a top-side RF ground, connect it directly to the GND pins. For a board where the ground is not on the component layer, connect the GND pins to the board with multiple vias close to the package.

## Chip Information

PROCESS: SiGe BiCMOS

## Package Information

For the latest package outline information and land patterns (footprints), go to [www.maxim-ic.com/packages](http://www.maxim-ic.com/packages). Note that a "+", "#", or "-" in the package code indicates RoHS status only. Package drawings may show a different suffix character, but the drawing pertains to the package regardless of RoHS status.

| PACKAGE TYPE | PACKAGE CODE | OUTLINE NO.             | LAND PATTERN NO.        |
|--------------|--------------|-------------------------|-------------------------|
| 6 μDFN       | L611+2       | <a href="#">21-0147</a> | <a href="#">90-0084</a> |

# GPS/GNSS Low-Noise Amplifier

## Revision History

| REVISION NUMBER | REVISION DATE | DESCRIPTION  | PAGES CHANGED |
|-----------------|---------------|--|---------------|
| 0               | 4/07          | Initial release  | —             |
| 1               | 5/08          | Updated Digital Input-Logic High specification and added RFIN DC Voltage specification in <i>DC Electrical Characteristics</i> table | 2             |
| 2               | 9/09          | Added MAX2659ELT/V+ to <i>Ordering Information</i>   | 1             |
| 3               | 1/11          | Updated maximum supply voltage specification to 3.6V   | 1, 2          |

Maxim cannot assume responsibility for use of any circuitry other than circuitry entirely embodied in a Maxim product. No circuit patent licenses are implied. Maxim reserves the right to change the circuitry and specifications without notice at any time.

Maxim Integrated Products, 120 San Gabriel Drive, Sunnyvale, CA 94086 408-737-7600 \_\_\_\_\_ 6