



# RF Power Field Effect Transistor Array

## N-Channel Enhancement-Mode Lateral MOSFET

Designed for broadband commercial and industrial applications with frequencies to 1000 MHz. The high gain and broadband performance of this device make it ideal for large-signal, common-source amplifier applications in 26 volt base station equipment. The device is in a PFP-16 Power Flat Pack package which gives excellent thermal performances through a solderable backside contact.

- Typical Performance at 960 MHz, 26 Volts  
 Output Power — 2 Watts Per Transistor  
 Power Gain — 18 dB  
 Efficiency — 50%
- Capable of Handling 10:1 VSWR, @ 26 Vdc, 960 MHz, 2 Watts CW Output Power

### Features

- Designed for Maximum Gain and Insertion Phase Flatness
- Excellent Thermal Stability
- Characterized with Series Equivalent Large-Signal Impedance Parameters
- RoHS Compliant
- In Tape and Reel. R2 Suffix = 1,500 Units per 16 mm, 13 inch Reel.

**MRF9002NR2**

**1000 MHz, 2 W, 26 V  
 LATERAL N-CHANNEL  
 BROADBAND  
 RF POWER MOSFET**

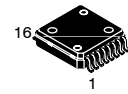

**CASE 978-03  
 PLASTIC  
 PFP-16**

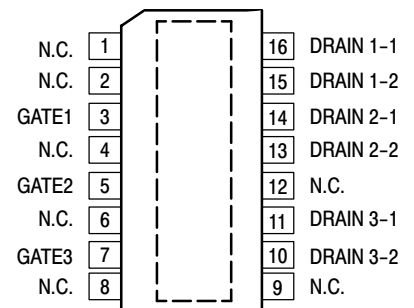

(Top View)

Note: Exposed backside flag is source terminal for transistors.

**Figure 1. Pin Connections**

**Table 1. Maximum Ratings**

Rating	Symbol	Value	Unit
Drain-Source Voltage	$V_{DSS}$	- 0.5, +65	Vdc
Gate-Source Voltage	$V_{GS}$	- 0.5, + 15	Vdc
Total Dissipation Per Transistor @ $T_C = 25^\circ\text{C}$	$P_D$	4	W
Storage Temperature Range	$T_{stg}$	- 65 to +150	$^\circ\text{C}$
Operating Junction Temperature	$T_J$	150	$^\circ\text{C}$

**Table 2. Thermal Characteristics**

Characteristic	Symbol	Value <sup>(1)</sup>	Unit
Thermal Resistance, Junction to Case, Single Transistor	$R_{\theta JC}$	12	$^\circ\text{C}/\text{W}$

**Table 3. Moisture Sensitivity Level**

Test Methodology	Rating	Package Peak Temperature	Unit
Per JESD 22-A113, IPC/JEDEC J-STD-020	3	260	$^\circ\text{C}$

1. MTTF calculator available at <http://www.freescale.com/rf>. Select Tools/Software/Application Software/Calculators to access the MTTF calculators by product.

**NOTE - CAUTION** - MOS devices are susceptible to damage from electrostatic charge. Reasonable precautions in handling and packaging MOS devices should be observed.

**Table 4. Electrical Characteristics** ( $T_C = 25^\circ\text{C}$  unless otherwise noted)

Characteristic	Symbol	Min	Typ	Max	Unit
<b>On Characteristics</b>					
Gate Threshold Voltage ( $V_{DS} = 10\text{ Vdc}$ , $I_D = 20\ \mu\text{Adc}$ )	$V_{GS(th)}$	2.4	—	4	Vdc
Gate Quiescent Voltage ( $V_{DS} = 26\text{ Vdc}$ , $I_D = 25\text{ mAdc}$ )	$V_{GS(Q)}$	3	—	5	Vdc
Drain-Source On-Voltage ( $V_{GS} = 10\text{ Vdc}$ , $I_D = 0.1\text{ Adc}$ )	$V_{DS(on)}$	—	0.3	—	Vdc
<b>Functional Tests</b> (Per Transistor in Freescale Test Fixture, 50 ohm system)					
Common-Source Amplifier Power Gain @ P1dB ( $V_{DD} = 26\text{ Vdc}$ , $I_{DQ} = 25\text{ mA}$ , $f = 960.0\text{ MHz}$ )	$G_{ps}$	15	18	—	dB
Drain Efficiency @ P1dB ( $V_{DD} = 26\text{ Vdc}$ , $I_{DQ} = 25\text{ mA}$ , $f = 960.0\text{ MHz}$ )	$\eta$	35	50	—	%
Input Return Loss @ P1dB ( $V_{DD} = 26\text{ Vdc}$ , $I_{DQ} = 25\text{ mA}$ , $f = 960.0\text{ MHz}$ )	IRL	—	- 15	- 9	dB
Power Output, 1 dB Compression Point ( $V_{DD} = 26\text{ Vdc}$ , $I_{DQ} = 25\text{ mA}$ , $f = 960.0\text{ MHz}$ )	$P_{1dB}$	34	37	—	dBm

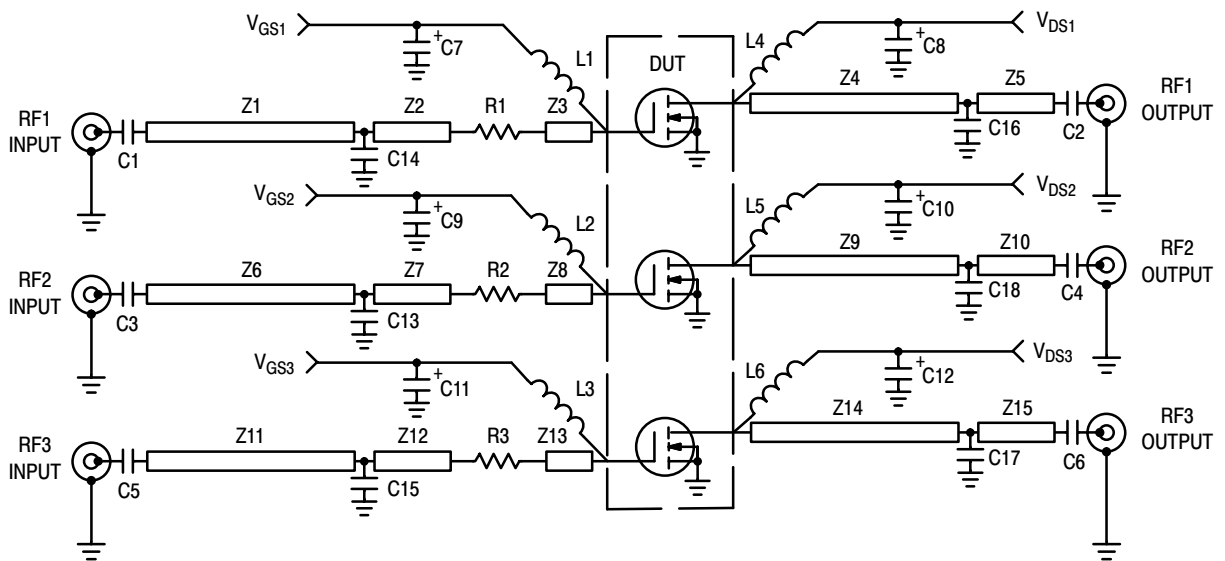
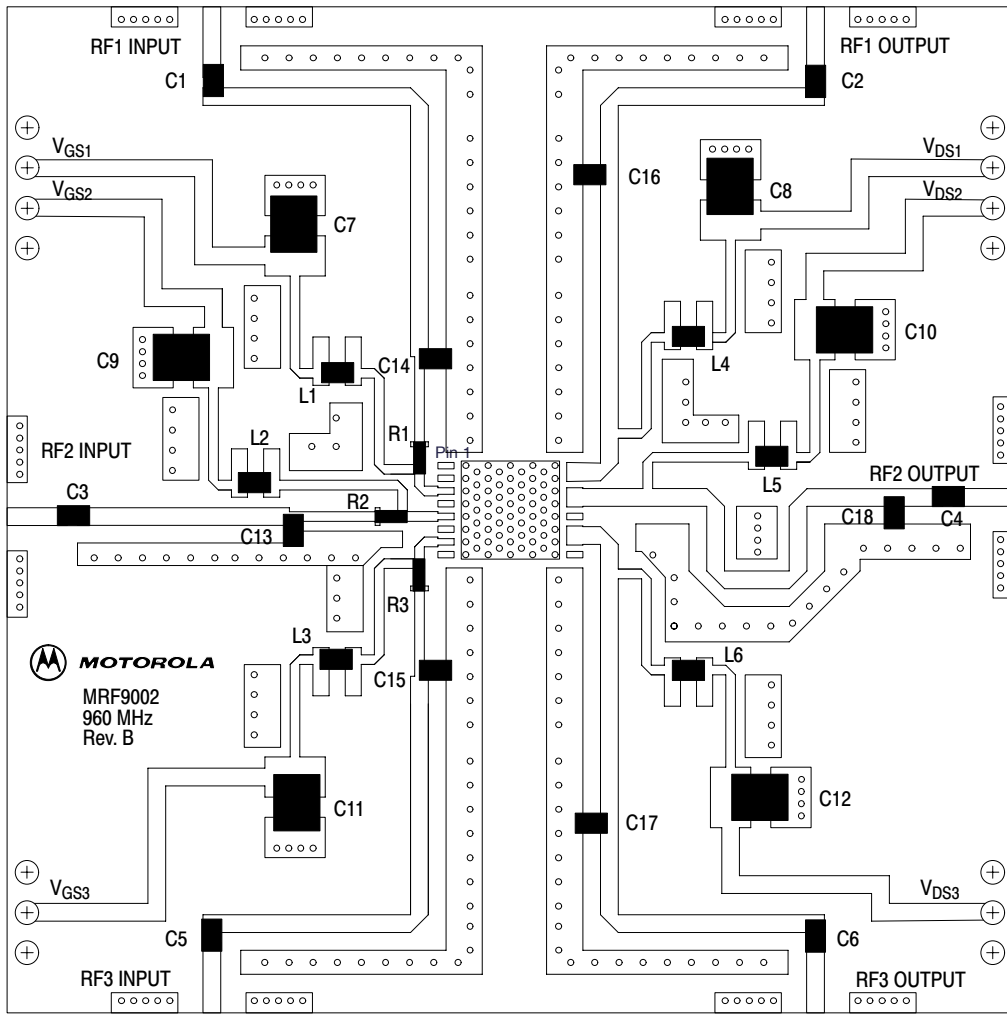

Figure 2. MRF9002NR2 Broadband Test Circuit Schematic

Table 5. MRF9002NR2 Broadband Test Circuit Component Designations and Values

Designators	Description
C1 - C6	33 pF Chip Capacitors (0805)
C7 - C12	1.0 $\mu$ F, 35 V Tantalum Capacitors, B Case, Kemet
C13	8.2 pF Chip Capacitor (0805)
C14, C15	10 pF Chip Capacitors (0805)
C16, C17	2.7 pF Chip Capacitors (0805)
C18	3.3 pF Chip Capacitor (0805)
L1 - L6	12 nH Chip Inductors (0805)
R1 - R3	0 $\Omega$ Chip Resistors (0805)
Z1, Z11	1.16 x 28.5 mm Microstrip
Z2, Z7, Z12	0.65 x 5.6 mm Microstrip
Z3, Z8, Z13	0.65 x 2.6 mm Microstrip
Z4, Z14	1.16 x 19.5 mm Microstrip
Z5, Z15	1.16 x 17.5 mm Microstrip
Z6	1.16 x 12.9 mm Microstrip
Z9	1.16 x 27.2 mm Microstrip
Z10	1.16 x 4.3 mm Microstrip
PCB	Etched Circuit Board
Raw PCB Material	Rogers RO4350, 0.020", 2.5", x 2.5", $\epsilon_r = 3.5$
Bedstead	Copper Heatsink



Freescale has begun the transition of marking Printed Circuit Boards (PCBs) with the Freescale Semiconductor signature/logo. PCBs may have either Motorola or Freescale markings during the transition period. These changes will have no impact on form, fit or function of the current product.

**Figure 3. MRF9002NR2 Broadband Test Circuit Component Layout**

## TYPICAL CHARACTERISTICS

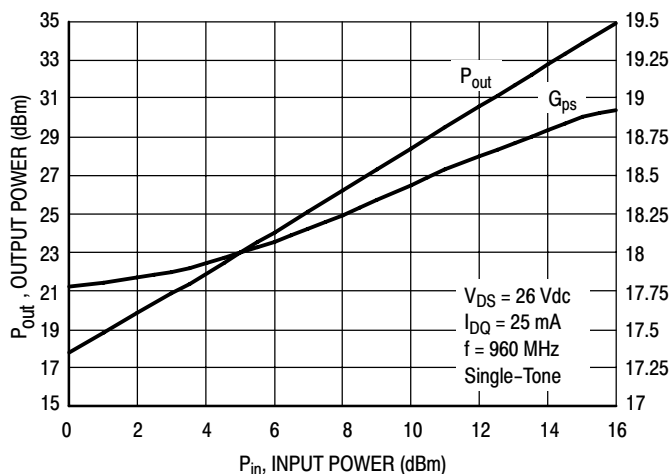

Figure 4. Output Power and Power Gain versus Input Power

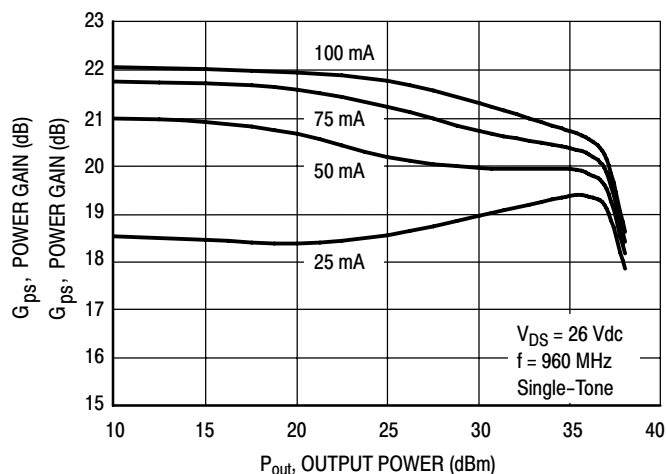

Figure 5. Power Gain versus Output Power

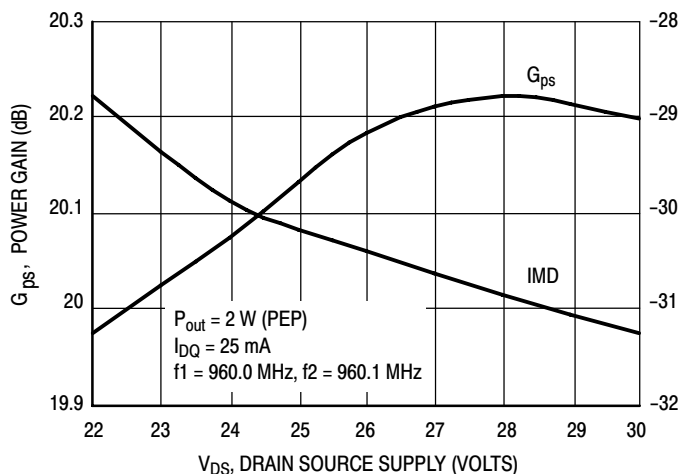

Figure 6. Power Gain and Intermodulation Distortion versus Supply Voltage

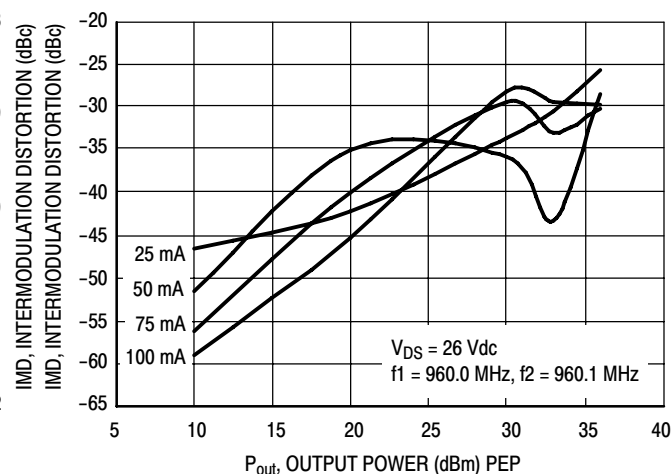

Figure 7. Intermodulation Distortion versus Output Power

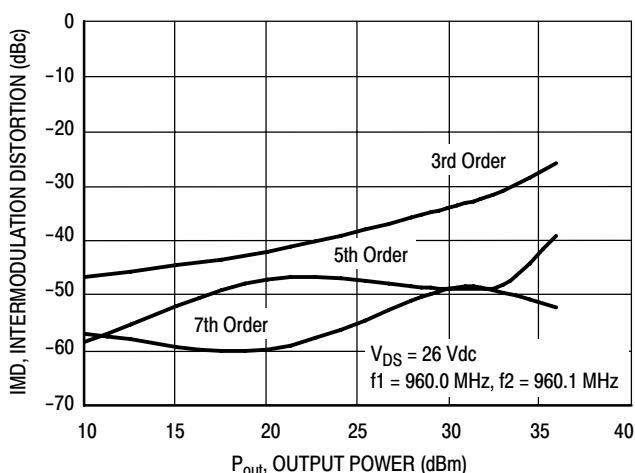

Figure 8. Intermodulation Distortion Products versus Output Power

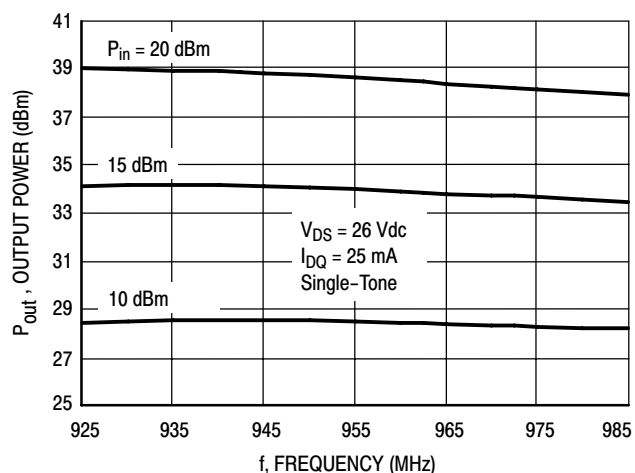
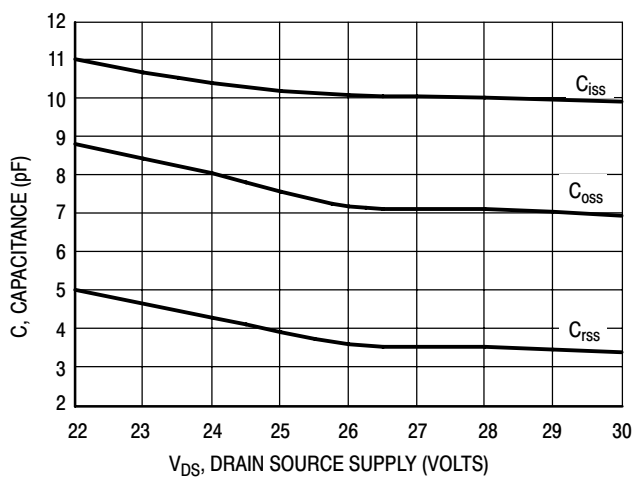
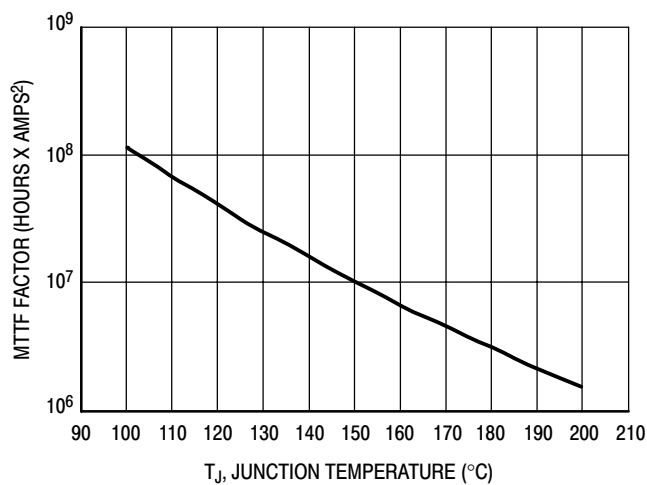

Figure 9. Output Power versus Frequency

## TYPICAL CHARACTERISTICS

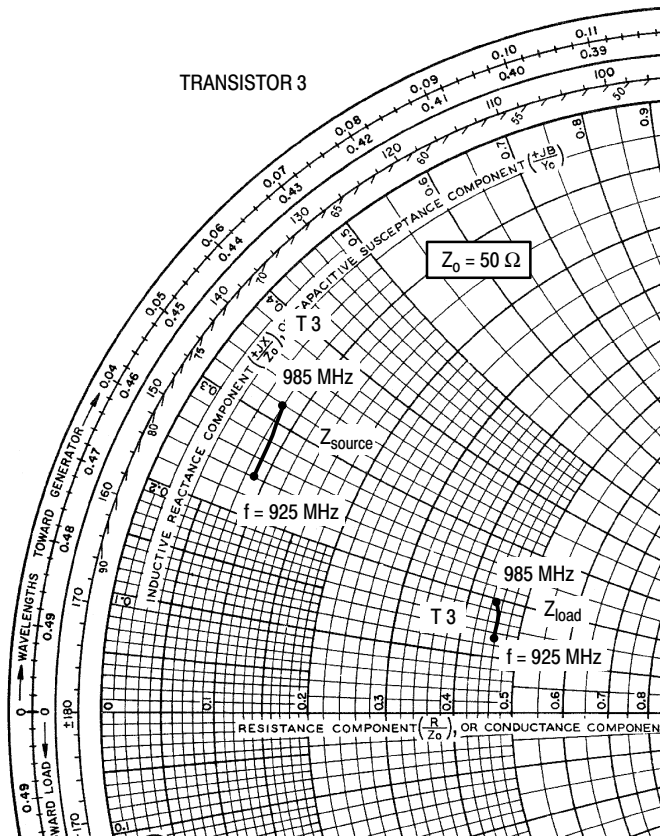
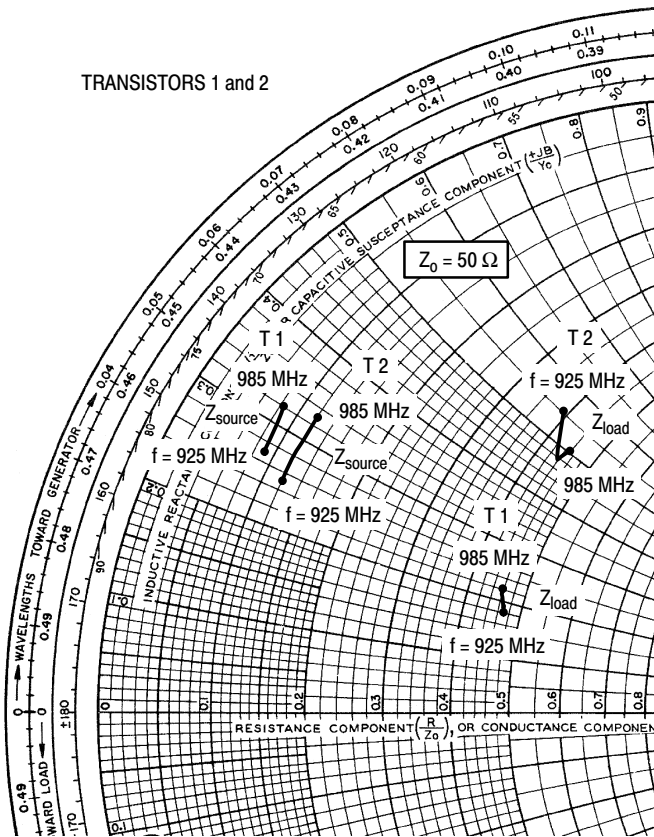

**Figure 10. Capacitance versus Drain Source Voltage**



This above graph displays calculated MTTF in hours x ampere<sup>2</sup> drain current. Life tests at elevated temperatures have correlated to better than  $\pm 10\%$  of the theoretical prediction for metal failure. Divide MTTF factor by  $I_D^2$  for MTTF in a particular application.

**Figure 11. MTTF Factor versus Junction Temperature**



$V_{DD} = 26 \text{ V}$ ,  $I_{DQ} = 25 \text{ mA}$ ,  $P_{out} = 2 \text{ W PEP}$

f MHz	$Z_{source}$ $\Omega$	$Z_{load}$ $\Omega$
925	$4.5 + j13.3$	$23.4 + j9.2$
960	$4.3 + j15.3$	$23.2 + j10.4$
985	$4.1 + j15.8$	$23.0 + j11.1$

**Transistor 1**

$V_{DD} = 26 \text{ V}$ ,  $I_{DQ} = 25 \text{ mA}$ ,  $P_{out} = 2 \text{ W PEP}$

f MHz	$Z_{source}$ $\Omega$	$Z_{load}$ $\Omega$
925	$6.0 + j12.3$	$19.7 + j27.8$
960	$5.9 + j14.3$	$22.0 + j23.9$
985	$5.8 + j16.5$	$22.5 + j25.4$

**Transistor 2**

$V_{DD} = 26 \text{ V}$ ,  $I_{DQ} = 25 \text{ mA}$ ,  $P_{out} = 2 \text{ W PEP}$

f MHz	$Z_{source}$ $\Omega$	$Z_{load}$ $\Omega$
925	$4.3 + j12.2$	$23.1 + j6.5$
960	$4.3 + j14.0$	$22.8 + j8.4$
985	$3.9 + j15.9$	$22.6 + j9.3$

**Transistor 3**

$Z_{source}$  = Test circuit impedance as measured from gate to ground.

$Z_{load}$  = Test circuit impedance as measured from drain to ground.

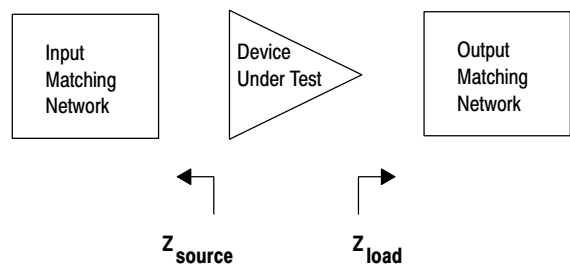

**Figure 12. Series Equivalent Source and Load Impedance**



## NOTES





## NOTES



## NOTES

## PACKAGE DIMENSIONS

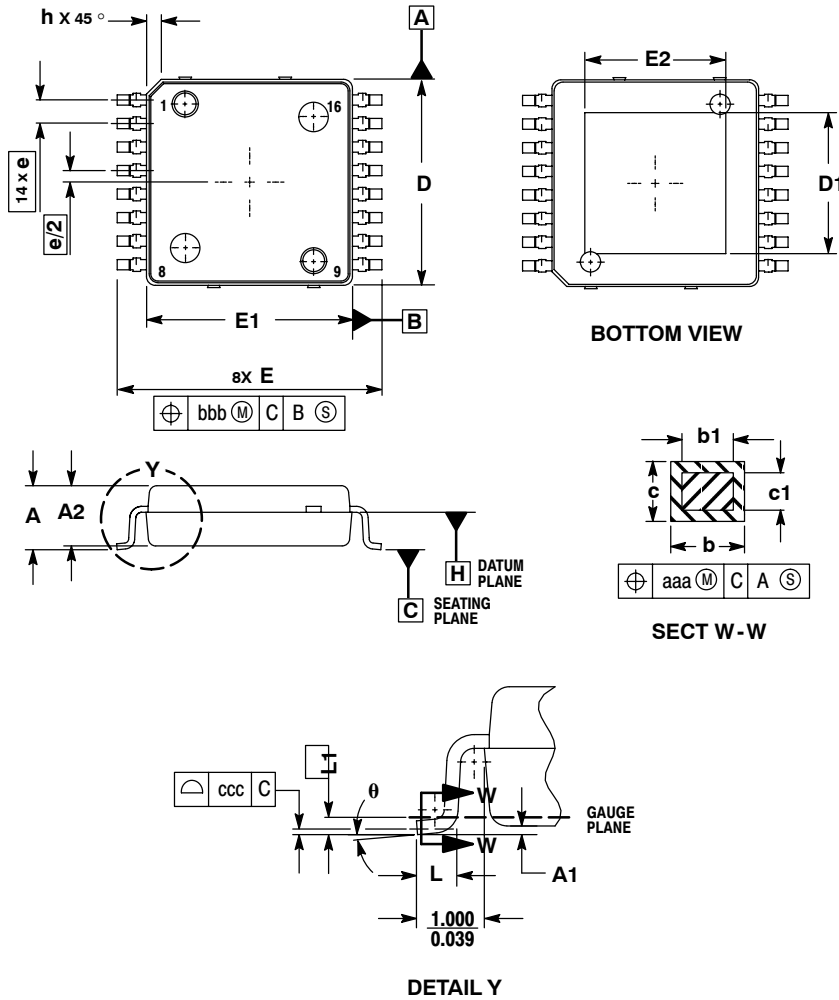

**NOTES:**

1. CONTROLLING DIMENSION: MILLIMETER.
2. DIMENSIONS AND TOLERANCES PER ASME Y14.5M, 1994.
3. DATUM PLANE -H- IS LOCATED AT BOTTOM OF LEAD AND IS COINCIDENT WITH THE LEAD WHERE THE LEAD EXITS THE PLASTIC BODY AT THE BOTTOM OF THE PARTING LINE.
4. DIMENSIONS D AND E1 DO NOT INCLUDE MOLD PROTRUSION. ALLOWABLE PROTRUSION IS 0.250 PER SIDE. DIMENSIONS D AND E1 DO INCLUDE MOLD MISMATCH AND ARE DETERMINED AT DATUM PLANE -H-.
5. DIMENSION b DOES NOT INCLUDE DAMBAR PROTRUSION. ALLOWABLE DAMBAR PROTRUSION IS 0.127 TOTAL IN EXCESS OF THE b DIMENSION AT MAXIMUM MATERIAL CONDITION.
6. DATUMS -A- AND -B- TO BE DETERMINED AT DATUM PLANE -H-.

DIM	MILLIMETERS	
	MIN	MAX
A	2.000	2.300
A1	0.025	0.100
A2	1.950	2.100
D	6.950	7.100
D1	4.372	5.180
E	8.850	9.150
E1	6.950	7.100
E2	4.372	5.180
L	0.466	0.720
L1	0.250 BSC	
b	0.300	0.432
b1	0.300	0.375
c	0.180	0.279
c1	0.180	0.230
e	0.800 BSC	
h	---	0.600
θ	0°	7°
aaa	0.200	
bbb	0.200	
ccc	0.100	

**CASE 978-03  
 ISSUE C  
 PLASTIC  
 PFP-16**

## **How to Reach Us:**

### **Home Page:**

[www.freescale.com](http://www.freescale.com)

### **E-mail:**

[support@freescale.com](mailto:support@freescale.com)

### **USA/Europe or Locations Not Listed:**

Freescale Semiconductor  
Technical Information Center, CH370  
1300 N. Alma School Road  
Chandler, Arizona 85224  
+1-800-521-6274 or +1-480-768-2130  
[support@freescale.com](mailto:support@freescale.com)

### **Europe, Middle East, and Africa:**

Freescale Halbleiter Deutschland GmbH  
Technical Information Center  
Schatzbogen 7  
81829 Muenchen, Germany  
+44 1296 380 456 (English)  
+46 8 52200080 (English)  
+49 89 92103 559 (German)  
+33 1 69 35 48 48 (French)  
[support@freescale.com](mailto:support@freescale.com)

### **Japan:**

Freescale Semiconductor Japan Ltd.  
Headquarters  
ARCO Tower 15F  
1-8-1, Shimo-Meguro, Meguro-ku,  
Tokyo 153-0064  
Japan  
0120 191014 or +81 3 5437 9125  
[support.japan@freescale.com](mailto:support.japan@freescale.com)

### **Asia/Pacific:**

Freescale Semiconductor Hong Kong Ltd.  
Technical Information Center  
2 Dai King Street  
Tai Po Industrial Estate  
Tai Po, N.T., Hong Kong  
+800 2666 8080  
[support.asia@freescale.com](mailto:support.asia@freescale.com)

### **For Literature Requests Only:**

Freescale Semiconductor Literature Distribution Center  
P.O. Box 5405  
Denver, Colorado 80217  
1-800-441-2447 or 303-675-2140  
Fax: 303-675-2150  
[LDCForFreescaleSemiconductor@hibbertgroup.com](mailto:LDCForFreescaleSemiconductor@hibbertgroup.com)

Information in this document is provided solely to enable system and software implementers to use Freescale Semiconductor products. There are no express or implied copyright licenses granted hereunder to design or fabricate any integrated circuits or integrated circuits based on the information in this document.

Freescale Semiconductor reserves the right to make changes without further notice to any products herein. Freescale Semiconductor makes no warranty, representation or guarantee regarding the suitability of its products for any particular purpose, nor does Freescale Semiconductor assume any liability arising out of the application or use of any product or circuit, and specifically disclaims any and all liability, including without limitation consequential or incidental damages. "Typical" parameters that may be provided in Freescale Semiconductor data sheets and/or specifications can and do vary in different applications and actual performance may vary over time. All operating parameters, including "Typicals", must be validated for each customer application by customer's technical experts. Freescale Semiconductor does not convey any license under its patent rights nor the rights of others. Freescale Semiconductor products are not designed, intended, or authorized for use as components in systems intended for surgical implant into the body, or other applications intended to support or sustain life, or for any other application in which the failure of the Freescale Semiconductor product could create a situation where personal injury or death may occur. Should Buyer purchase or use Freescale Semiconductor products for any such unintended or unauthorized application, Buyer shall indemnify and hold Freescale Semiconductor and its officers, employees, subsidiaries, affiliates, and distributors harmless against all claims, costs, damages, and expenses, and reasonable attorney fees arising out of, directly or indirectly, any claim of personal injury or death associated with such unintended or unauthorized use, even if such claim alleges that Freescale Semiconductor was negligent regarding the design or manufacture of the part.

Freescale™ and the Freescale logo are trademarks of Freescale Semiconductor, Inc. All other product or service names are the property of their respective owners.

© Freescale Semiconductor, Inc. 2006. All rights reserved.

RoHS-compliant and/or Pb-free versions of Freescale products have the functionality and electrical characteristics of their non-RoHS-compliant and/or non-Pb-free counterparts. For further information, see <http://www.freescale.com> or contact your Freescale sales representative.

For information on Freescale's Environmental Products program, go to <http://www.freescale.com/epc>.

