

FGR3000FX-90DA

HIGH POWER INVERTER USE
PRESS PACK TYPE

FGR3000FX-90DA

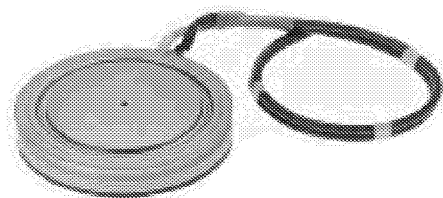

- ITQRM Repetitive controllable on-state current 3000A
- IT(AV) Average on-state current 780A
- VDRM Repetitive peak off state voltage 4500V
- Reverse conducting type

OUTLINE DRAWING

Dimensions in mm

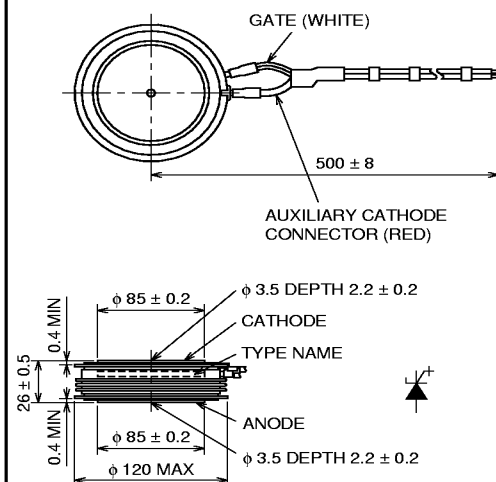

APPLICATION

Inverters, D.C. choppers, Induction heaters, D.C. to D.C. converters.

MAXIMUM RATINGS

Symbol	Parameter	Voltage class		Unit
		90DA		
VDRM	Repetitive peak off-state voltage*	4500		V
VDSM	Non-repetitive peak off-state voltage*	4500		V
VD(DC)	DC off-state voltage*	3600		V
VLTD5	Long term DC stability voltage*	3000		V

* : Vgk = -2V

Symbol	Parameter	Conditions	Ratings	Unit
ITQRM	Repetitive controllable on-state current	VDM = 4500V, Tj = 125°C, Cs = 6.0μF, Ls = 0.2μH	3000	A
IT(RMS)	RMS on-state current		1220	A
IT(AV)	Average on-state current	f = 60Hz, sine wave θ = 180°, Tf = 70°C	780	A
ITSM	Surge (non-repetitive) on-state current	One half cycle at 60Hz	16	kA
IT ² t	I ² t for fusing	One cycle at 60Hz	1.0 × 10 ⁶	A ² s
IR(RMS)	RMS Reverse current		940	A
IR(AV)	Average reverse current	f = 60Hz, sine wave θ = 180°C, Tf = 75°C	600	A
IRSM	Surge (non-repetitive) reverse current	One half cycle at 60Hz	16	kA
IR ² t	Current-squared, time integration	One cycle at 60Hz	1.0 × 10 ⁶	A ² s
diT/dt	Critical rate of rise of on-state current	VD = 3000V, IGM = 75A, Tj = 75°C	500	A/μs
VFGM	Peak forward gate voltage		10	V
VRGM	Peak reverse gate voltage		18	V
IFGM	Peak forward gate current		100	A
IRGM	Peak gate reverse current		900	A
PFGM	Peak forward gate power dissipation		400	W
PRGM	Peak reverse gate power dissipation		27	kW
PFG(AV)	Average forward gate power dissipation		100	W
PRG(AV)	Average reverse gate power dissipation		230	W
Tj	Junction temperature		-40 ~ +125	°C
Tstg	Storage temperature		-40 ~ +150	°C
—	Mounting force required	Recommended value 37	31 ~ 43	kN
—	Weight	Standard value	1450	g

Aug.1998



FGR3000FX-90DA

HIGH POWER INVERTER USE
PRESS PACK TYPE

ELECTRICAL CHARACTERISTICS

Symbol	Parameter	Test conditions	Limits			Unit
			Min	Typ	Max	
V _{TM}	On-state voltage	T _J = 125°C, I _{TM} = 3000A, Instantaneous measurment	—	—	5.0	V
V _{RM}	Peak reverse voltage drop	T _J = 125°C, I _{RM} = 3000A, Instantaneous measurment	—	—	4.5	V
I _{DRM}	Repetitive peak off-state current	T _J = 125°C, V _{DRM} Applied, V _{GK} = -2V	—	—	250	mA
I _{RG}	Reverse gate current	T _J = 125°C, V _{RG} = 17V	—	—	500	mA
dv/dt	Critical rate of rise of off-state voltage	T _J = 125°C, V _D = 3000V, V _{GK} = -2V	1000	—	—	V/μs
t _{gt}	Turn-on time	T _J = 125°C, I _{TM} = 3000A, I _{GM} = 75A, V _D = 3000V	—	—	10	μs
t _{gq}	Turn-off time	T _J = 125°C, I _{TM} = 3000A, V _{DM} = 4500V, diGQ/dt = -30A/μs V _{RG} = 17V, C _s = 6.0μF, L _s = 0.2μH	—	—	30	μs
I _{GQM}	Peak gate turn-off current		—	720	—	A
V _{GT}	Gate trigger voltage	DC METHOD : V _D = 24V, R _L = 0.1Ω, T _J = 25°C	—	—	1.5	V
I _{GT}	Gate trigger current		—	—	3000	mA
R _{th(j-f)}	Thermal resistance	GTO Side (Junction to fin)	—	—	0.016	°C/W
		Diode Side (Junction to fin)	—	—	0.025	

PERFORMANCE CURVES

MAXIMUM ON-STATE AND MAXIMUM REVERSE CHARACTERISTICS

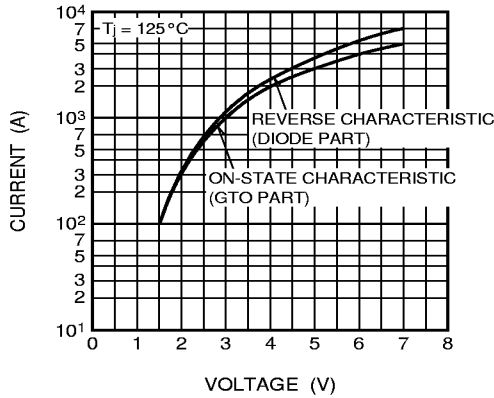

RATED ON-STATE AND REVERSE SURGE CURRENT

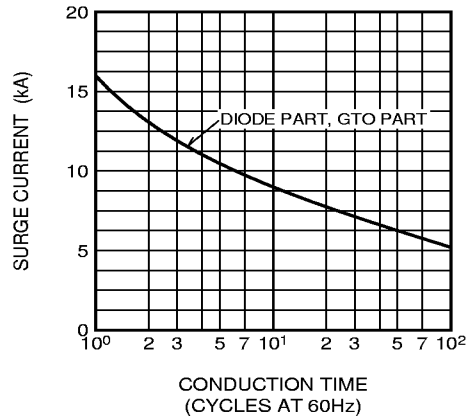

GATE CHARACTERISTICS

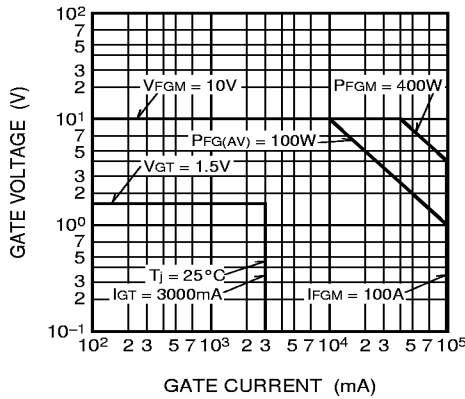

MAXIMUM THERMAL IMPEDANCE CHARACTERISTICS (JUNCTION TO FIN)

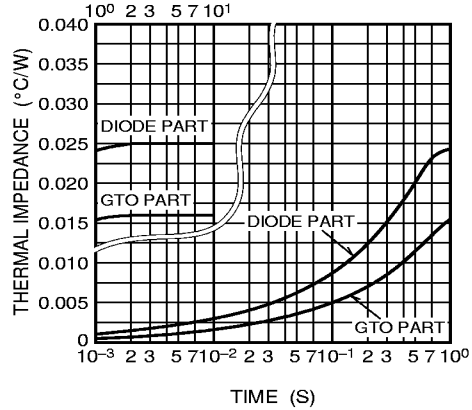

FGR3000FX-90DA

**HIGH POWER INVERTER USE
PRESS PACK TYPE**

MAXIMUM ON-STATE POWER DISSIPATION CHARACTERISTICS (GTO PART, SINGLE-PHASE HALF WAVE)

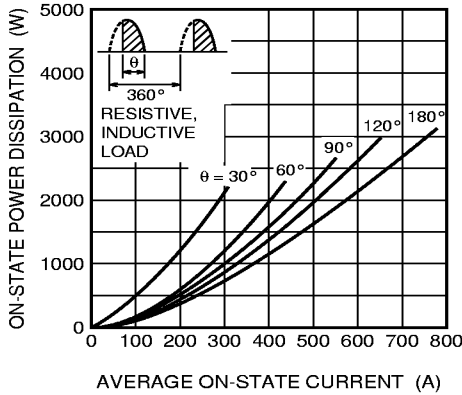

ALLOWABLE FIN TEMPERATURE VS. AVERAGE ON-STATE CURRENT (GTO PART, SINGLE-PHASE HALF WAVE)

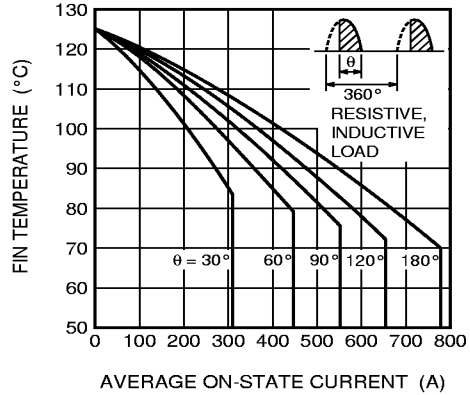

MAXIMUM ON-STATE POWER DISSIPATION CHARACTERISTICS (GTO PART, RECTANGULAR WAVE)

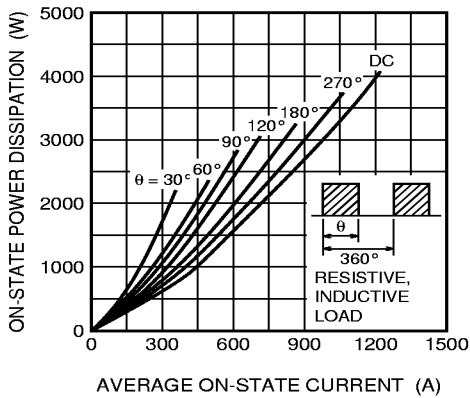

ALLOWABLE FIN TEMPERATURE VS. AVERAGE ON-STATE CURRENT (GTO PART, RECTANGULAR WAVE)

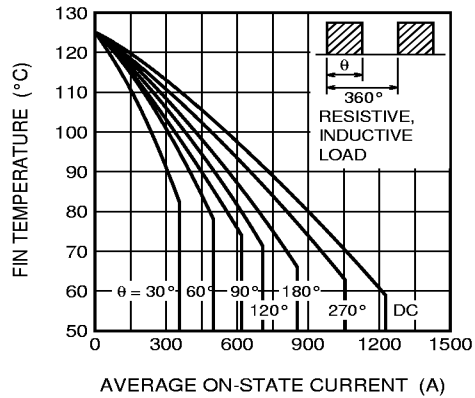

MAXIMUM REVERSE POWER DISSIPATION CHARACTERISTICS (DIODE PART, SINGLE PHASE WAVE)

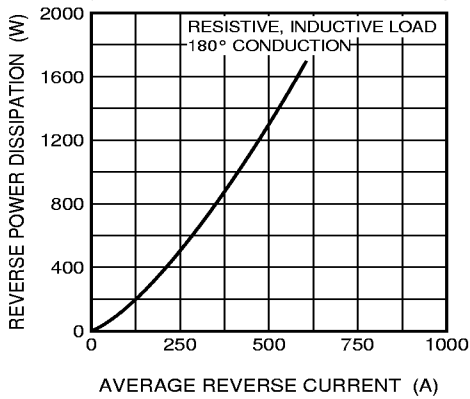

ALLOWABLE FIN TEMPERATURE VS. AVERAGE REVERSE CURRENT (DIODE PART, SINGLE PHASE HALF WAVE)

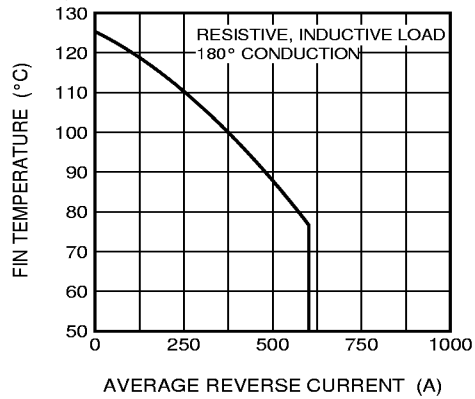

FGR3000FX-90DA

HIGH POWER INVERTER USE
PRESS PACK TYPE

GATE TRIGGER CURRENT VS. JUNCTION TEMPERATURE (TYPICAL)

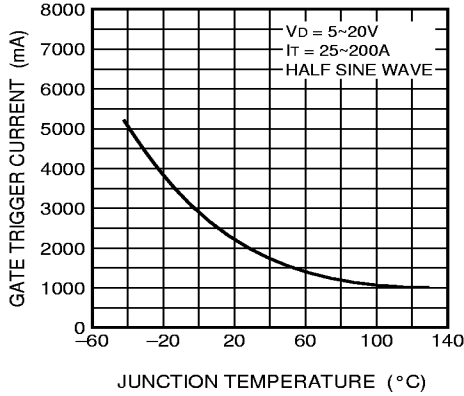

TURN ON TIME, TURN ON DELAY TIME VS. TURN ON GATE CURRENT (TYPICAL)

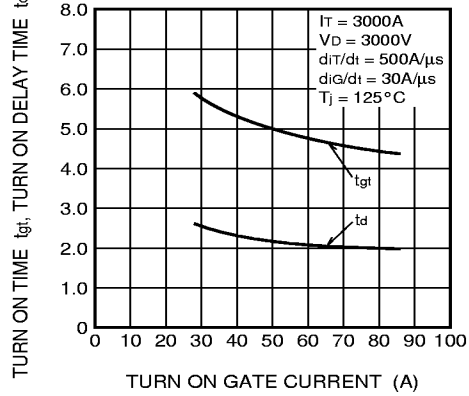

TURN OFF TIME, TURN OFF STORAGE TIME VS. TURN OFF GATE CURRENT (TYPICAL)

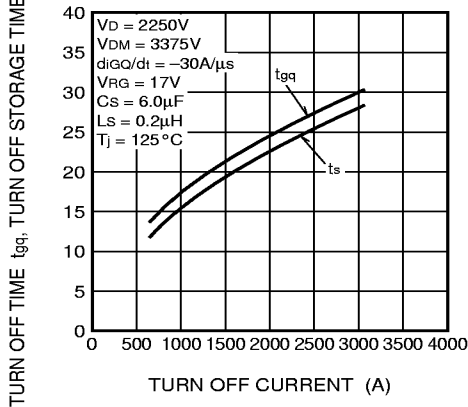

TURN OFF TIME, TURN OFF STORAGE TIME VS. RATE OF RISE OF TURN OFF GATE CURRENT (TYPICAL)

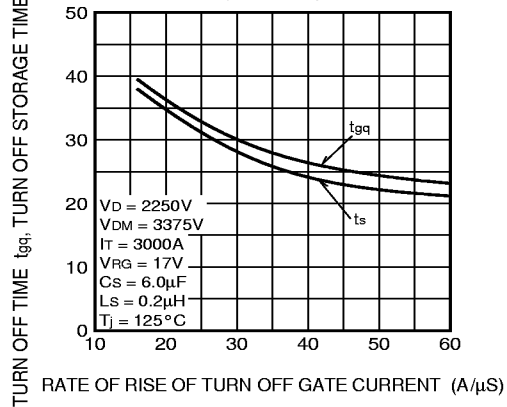

TURN OFF GATE CURRENT VS. TURN OFF CURRENT (TYPICAL)

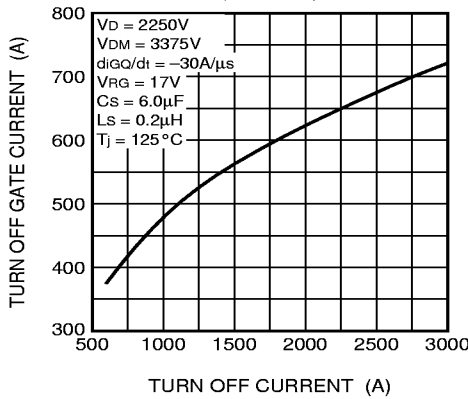

TURN OFF GATE CURRENT VS. RATE OF RISE OF GATE CURRENT (TYPICAL)

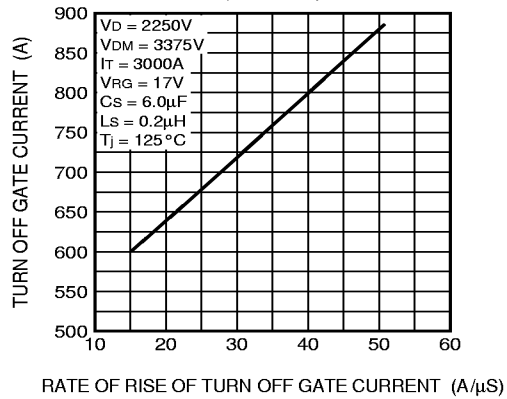

FGR3000FX-90DA

HIGH POWER INVERTER USE
PRESS PACK TYPE

