

HA12141NT, HA12151MA, HA12161FP T-77-21 HA12142NT, HA12153MA, HA12162FP

Dolby B- and C-Type Noise Reduction System

Description

HA12141 series are silicon monolithic bipolar IC series providing dual channel Dolby B- and C-type noise reduction in one chip.

These ICs are available only to licenses of Dolby Laboratories Licensing Corporation.

Licensing and application information may be obtained from Dolby Laboratories Licensing Corporation.

HA12141 series provide the following functions and features.

Functions

- Dual Dolby B/C-type NR processor
- NR OFF/B/C control switch
- MPX by-pass/encode/decode (MPX OFF/REC/PB) control switch
- MPX filter drive circuit

Features

- Low external parts count
- R-C spectrum skewing network using passive components
- External capacitors are E-3 series (small valves)
- Several time constant capacitors built into the IC
- Separate REC/PB input and output. Unprocessed signal output available in the encode and decode modes.
- Common PCB pattern is available with HA12134A series (Dolby B NR), because these ICs offer similar pin layout.
- 2 type PB-OUT level (300 mV, 580 mV)
- 3 type package (DP-30S, MP-44S, FP-28D) Wide range of operating supply voltage (7.5 V to 16 V)

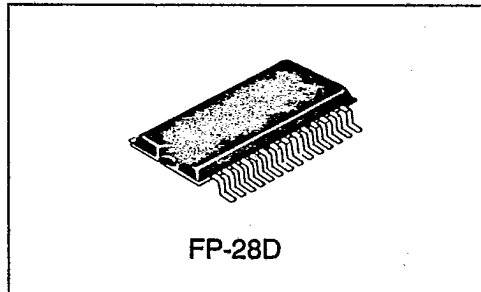

Dolby is a trademark of Dolby Laboratories Licensing Corporation.

Table 1 Ordering Information

Type No.	Package	Dolby level	PB-OUT level	REC-OUT level	Note
HA12141NT	DP-30S	300 mVrms	300 mVrms	300 mVrms	
HA12142NT	DP-30S	300 mVrms	580 mVrms	300 mVrms	
HA12151MA	MP-44S	300 mVrms	300 mVrms	300 mVrms	L, Rch separate control SW
HA12153MA	MP-44S	300 mVrms	580 mVrms	300 mVrms	↓
HA12161FP	FP-28D	300 mVrms	300 mVrms	—	PB-mode only
HA12162FP	FP-28D	300 mVrms	580 mVrms	—	↓



HA12141NT, HA12151MA, HA12161FP, HA12142NT, HA12153MA, HA12162FP

Table 2 Absolute Maximum Ratings
 Ta = 25°C, unless otherwise specified

T-77-21

Item	Symbol	Rating	Unit	Note
Supply voltage	V _{CCmax}	16	V	
Power dissipation	P _T	400	mW	Ta ≤ 85°C
Operating temperature	T _{opr}	-40 to +85	°C	
Storage temperature	T _{stg}	-55 to +125	°C	

Table 3 Electrical Characteristics (HA12141NT, HA12142NT, HA12151MA, HA12153MA)
 Ta = 25°C, V_{CC} = 12 V, unless otherwise specified
 Dolby Level = 300 mVrms at TP (REC-mode: TP2, TP4 PB-mode: TP1, TP3)

Item	Symbol	Min	Typ	Max	Unit	Test conditions				
						R/P	NR	f (Hz)	Other conditions	
Operating voltage	HA12141NT HA12151MA	V _{opr}	7.5	12.0	16.0	V	—	—	—	
	HA12142NT HA12153MA		9.5	12.0	16.0	V				
Quiescent current	I _{CC}	—	12.0	—	mA	R	OFF	—	No signal	
Input amp gain	G _v (IA REC)	18.0	20.0	22.0	dB	R	OFF	1 k	V _{in} = 0 dB	
	G _v (IA PB)	18.0	20.0	22.0	dB	P	OFF	1 k		
B-type NR Encode boost	B-ENC-2 k	2.8	4.3	5.8	dB	R	B	2 k	V _{in} = -20 dB	
	B-ENC-5 k	1.7	3.2	4.7	dB	R	B	5 k	V _{in} = -20 dB	
C-Type NR Encode boost	C-ENC-1 k (1)	3.9	5.9	7.9	dB	R	C	1 k	V _{in} = -20 dB	
	C-ENC-1 k (2)	18.1	19.6	21.6	dB	R	C	1 k	V _{in} = -60 dB	
	C-ENC-700	9.8	11.8	13.8	dB	R	C	700	V _{in} = -30 dB	
Signal handling	HA12141NT HA12151MA	V _{omax}	12.0	13.0	—	dB	R	OFF	1 k	THD = 1% V _{CC} = 7.5 V
	HA12142NT HA12153MA		12.0	13.0	—	dB				V _{CC} = 9.5 V



HA12141NT, HA12151MA, HA12161FP, HA12142NT, HA12153MA, HA12162FP

Electrical Characteristics (cont)

Ta = 25°C, V_{CC} = 12 V, unless otherwise specified
 Dolby Level = 300 mVrms at TP (REC-mode: TP2, TP4 PB-mode: TP1, TP3)

T-77-21

Item	Symbol	Min	Typ	Max	Unit	Test conditions				
						R/P	NR	f (Hz)	Other conditions	
Signal to noise ratio	S/N (REC)	60.0	64.0	—	dB	R	C	—	R _g = 5.1 kΩ CCIR/ARM	
Total harmonic distortion	THD (OFF)	—	0.03	0.15	%	R	OFF	1 k	V _{in} = 0 dB	
	THD (C)	—	0.09	0.3	%	R	C	1 k	V _{in} = 0 dB	
NR OFF frequency response	FR-OFF	-3.0	0.0	+3.0	dB	P	OFF	100 k	V _{in} = 0 dB	
Crosstalk between REC-PB	CT (R→P)	—	80.0	—	dB	P	OFF	1 k	V _{in} = 0 dB	
	CT (P→R)	—	80.0	—	dB	R	OFF	1 k		
Crosstalk between channel	CT (L→R)	—	85.0	—	dB	R	OFF	1 k	V _{in} = 0 dB	
	CT (R→L)	—	85.0	—	dB					
Control voltage for MPX OFF/REC/PB	V _{cont} (MPX)	V _{CC} -1	—	V _{CC}	V					
	V _{cont} (REC)	2.5	—	$\frac{V_{CC}}{2} + 0.5$	V					
	V _{cont} (PB)	0.0	—	0.4	V					
Control voltage for NR C/B OFF	V _{cont} (C)	$\frac{V_{CC}}{2} + 3$	—	V _{CC}	V					
	V _{cont} (B)	$\frac{V_{CC}}{2} - 0.5$	—	$\frac{V_{CC}}{2} + 0.5$	V					
	V _{cont} (OFF)	0.0	—	$\frac{V_{CC}}{2} - 3$	V					
PB-OUT level	HA12141NT HA12151MA	V _{out}	250	300	350	mVrms	R	OFF	1 k	V _{in} = 0 dB
		HA12142NT HA12153MA	490	580	670	mVrms				
REC-OUT offset	V _{offset}	-70	0.0	70	mV	R	OFF	—	No signal	
Channel balance	ΔGv	-1.0	0.0	1.0	dB	R	OFF	1 k	V _{in} = 0 dB	

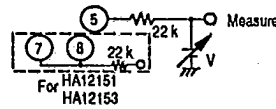
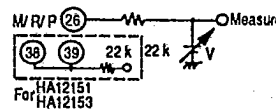

T-77-21

HA12141NT, HA12151MA, HA12161FP, HA12142NT, HA12153MA, HA12162FP

Table 4 Electrical Characteristics (HA12161FP, HA12162FP)

Ta = 25°C, V_{CC} = 12 V, Unless otherwise specified
 Dolby Level = 300 mVrms at TP (PB-mode: TP1, TP3)

Item	Symbol	Min	Typ	Max	Unit	Test conditions				
						P/AUX	NR	f (Hz)	Other conditions	
Operating voltage	HA12161FP	V _{opr}	7.5	12.0	16.0	V	—	—	—	
	HA12162FP		9.5	12.0	16.0	V				
Quiescent current	I _{CC}	—	12.0	—	mA	P	OFF	—	No signal	
Input amp gain	G _v (IA AUX 1)	18.0	20.0	22.0	dB	AUX 1	OFF	1 k	V _{in} = 0 dB	
	G _v (IA PB)	18.0	20.0	22.0	dB	P	OFF	1 k		
B-type NR decode cut	B-DEC-2 k	-5.8	-4.3	-2.8	dB	P	B	2 k	V _{out} = -20 dB	
	B-DEC-5 k	-4.7	-3.2	-1.7	dB	P	B	5 k	V _{out} = -20 dB	
C-Type NR decode cut	C-DEC-1 k (1)	-7.9	-5.9	-3.9	dB	P	C	1 k	V _{out} = -20 dB	
	C-DEC-1 k (2)	-21.6	-19.6	-18.1	dB	P	C	1 k	V _{out} = -60 dB	
Signal handling	HA12161FP	V _{omax}	12.0	13.0	—	dB	P	OFF	1 k	THD = 1% V _{CC} =7.5 V
	HA12162FP		12.0	13.0	—	dB				V _{CC} =9.5 V
Signal to noise ratio	S/N (PB)	70.0	76.0	—	dB	P	OFF	—	R _g = 10 kΩ CCIR/ARM	
Total harmonic distortion	THD (OFF)	—	0.03	0.15	%	P	OFF	1 k	V _{in} = 0 dB	
	THD (C)	—	0.09	0.3	%	P	C	1 k	V _{in} = 0 dB	
NR OFF frequency response	FR-OFF	-4.0	-1.0	+3.0	dB	P	OFF	100 k	V _{in} = 0 dB	
Crosstalk between AUX 1→PB	CT (AUX 1→PB)	—	80.0	—	dB	P	OFF	1 k	V _{in} = 0 dB	



HA12141NT, HA12151MA, HA12161FP, HA12142NT, HA12153MA, HA12162FP

Electrical Characteristics (cont)

Ta = 25°C, V_{CC} = 12 V, Unless otherwise specified

Dolby Level = 300 mVrms at TP (PB-mode: TP1, TP3)

T-77-21

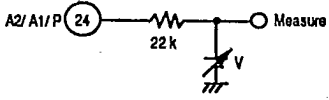
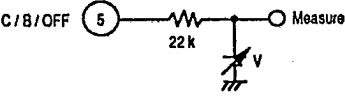
Item	Symbol	Min	Typ	Max	Unit	Test conditions				
						P/AUX	NR	f (Hz)	Other conditions	
Crosstalk between channel	CT (L→R)	—	85.0	—	dB	P	OFF	1 k	V _{in} = 12 dB	
	CT (R→L)	—	85.0	—	dB					
Control voltage for AUX 2/AUX 1/PB	V _{cont} (AUX 2)	V _{CC} -1	—	V _{CC}	V					
	V _{cont} (AUX 1)	2.5	—	$\frac{V_{CC}}{2} + 0.5$	V					
	V _{cont} (PB)	0.0	—	0.4	V					
Control voltage for NR C/B OFF	V _{cont} (C)	$\frac{V_{CC}}{2} + 3$	—	V _{CC}	V					
	V _{cont} (B)	$\frac{V_{CC}}{2} - 0.5$	—	$\frac{V_{CC}}{2} + 0.5$	V					
	V _{cont} (OFF)	0.0	—	$\frac{V_{CC}}{2} + 3$	V					
PB-OUT level	HA12161FP	V _{out}	250	300	350	mVrms	P	OFF	1 k	V _{in} = 0 dB
	HA12162FP		490	580	670	mVrms				
PB-OUT offset	V _{offset}	-100	0.0	+100	mV	P	OFF	—	No signal	→ C
Channel balance	ΔG _v	-1.0	0.0	1.0	dB	P	OFF	1 k	V _{in} = 0 dB	



HA12141NT, HA12151MA, HA12161FP, HA12142NT, HA12153MA, HA12162FP

HA12141NT Series Block Diagram

T-77-21

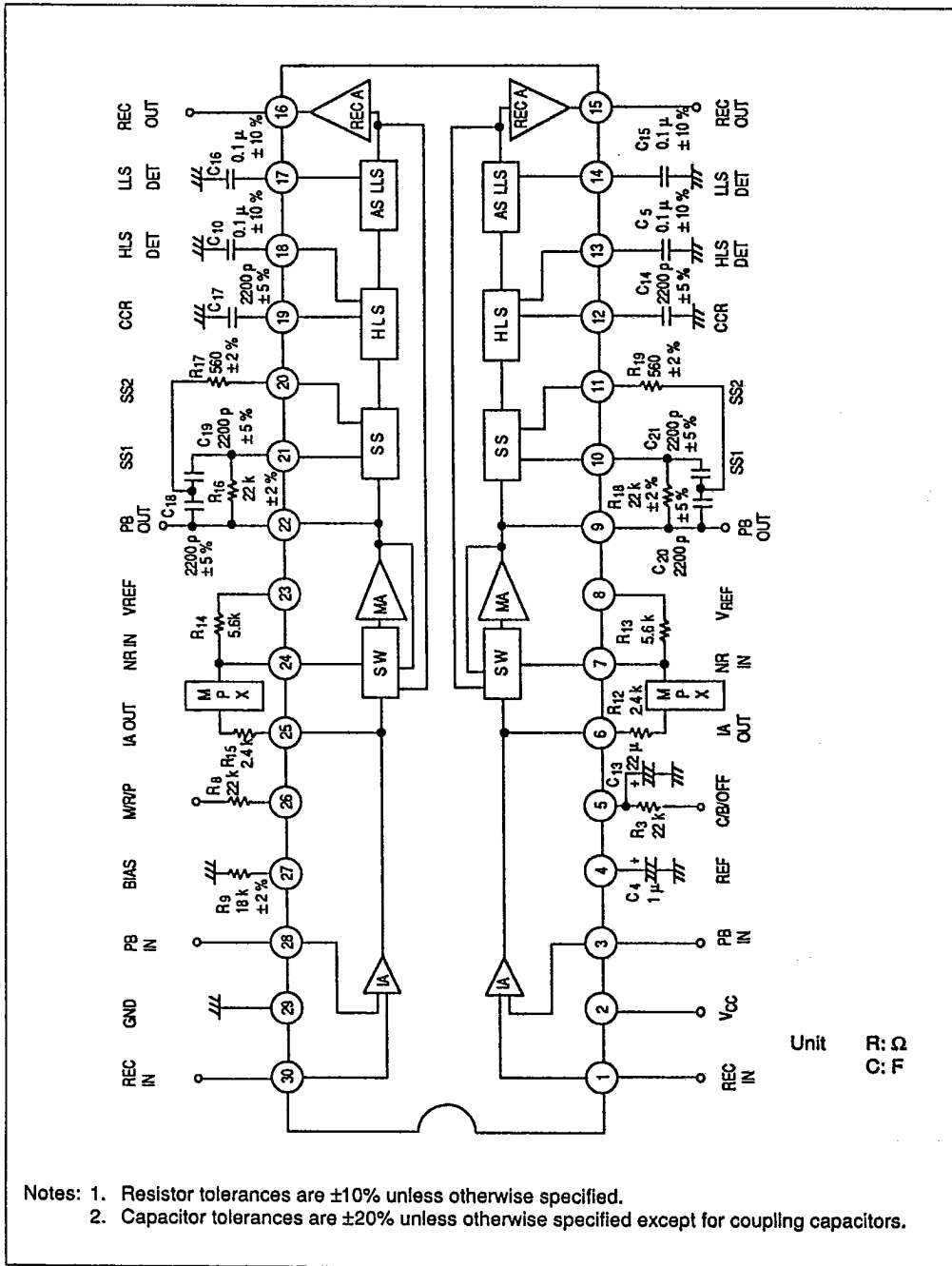

HA12141NT, HA12151MA, HA12161FP, HA12142NT, HA12153MA, HA12162FP

HA12151MA Series Block Diagram

T-77-21

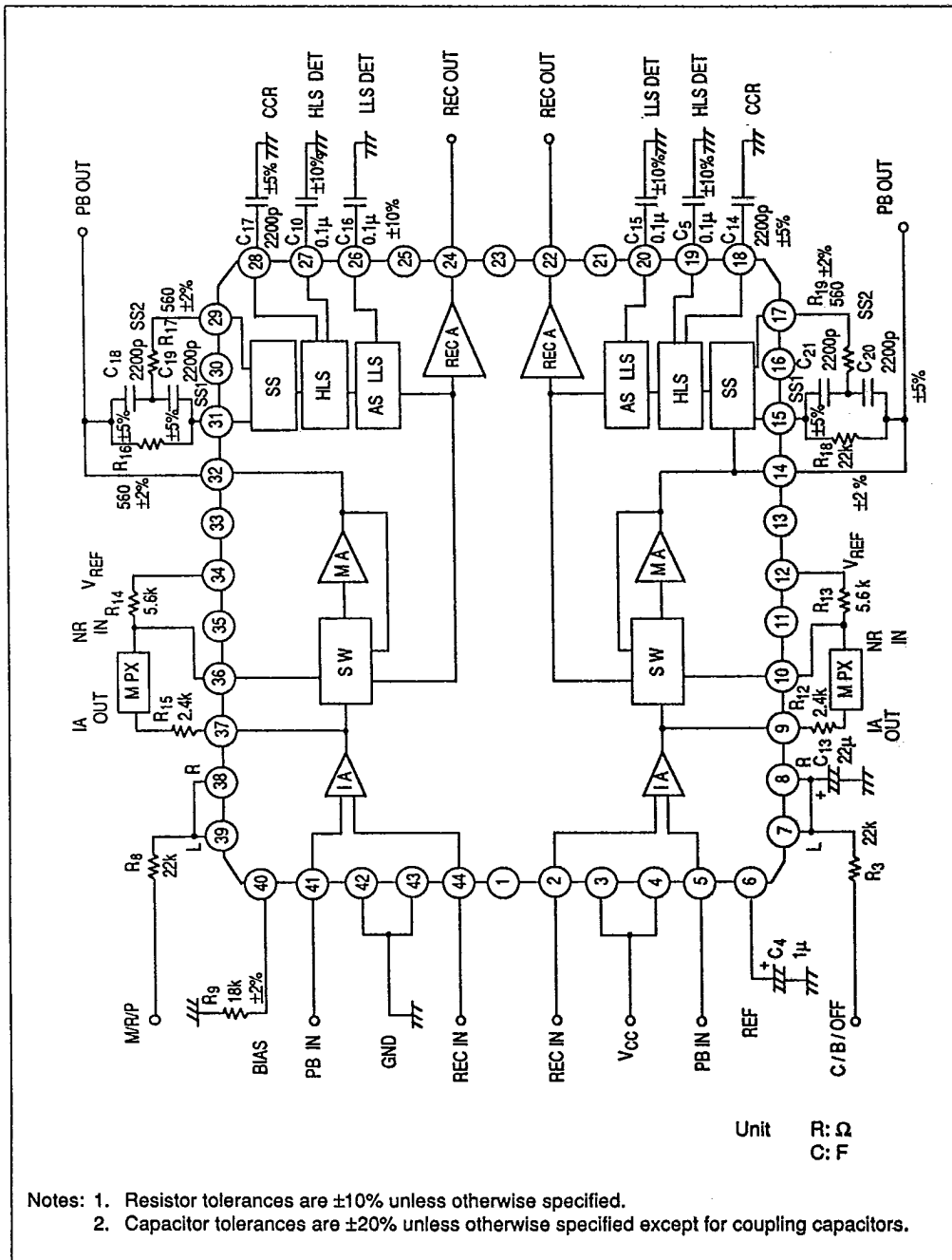

HA12141NT, HA12151MA, HA12161FP, HA12142NT, HA12153MA, HA12162FP

HA12161FP Series Block Diagram

T-77-21

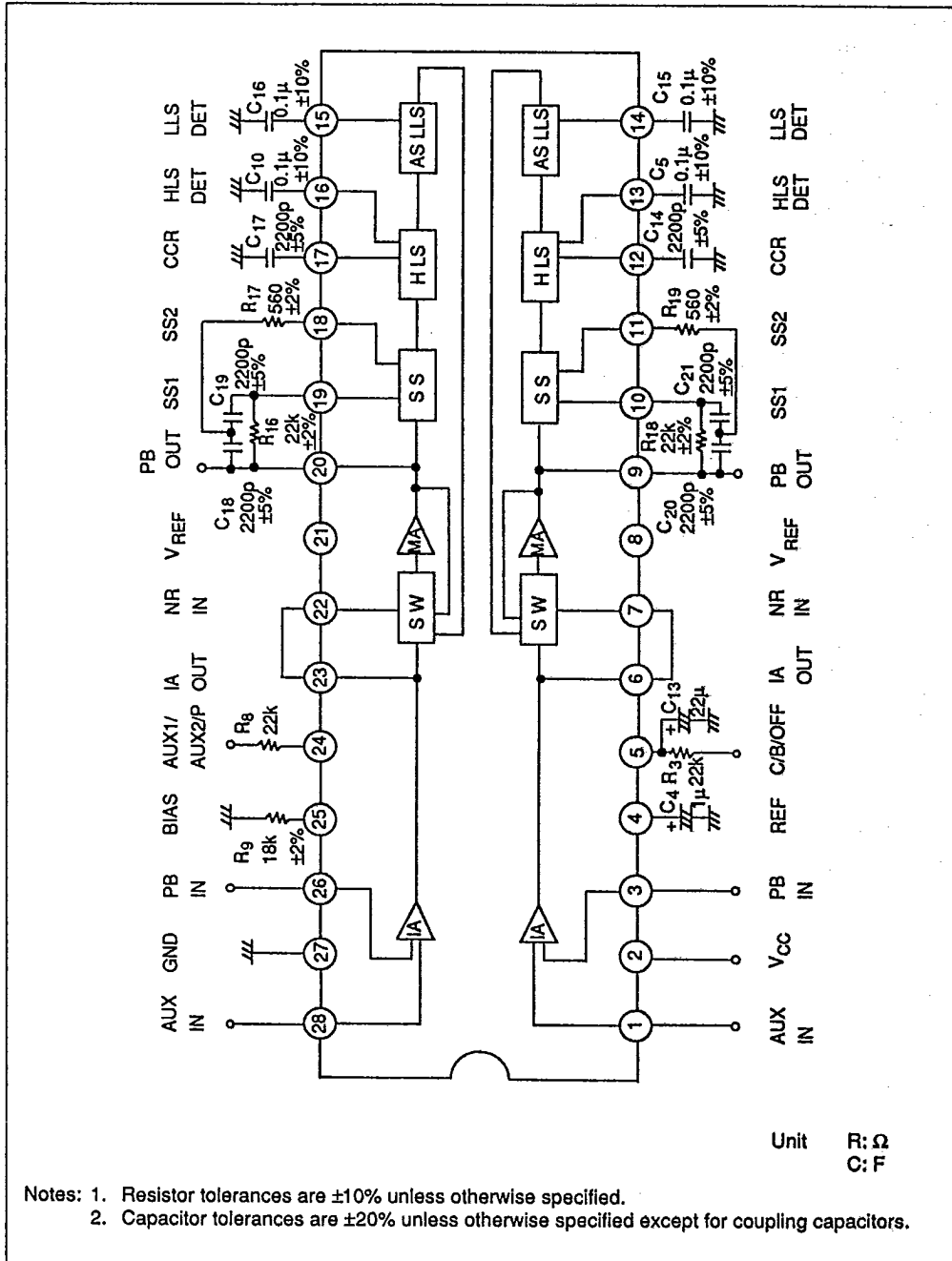

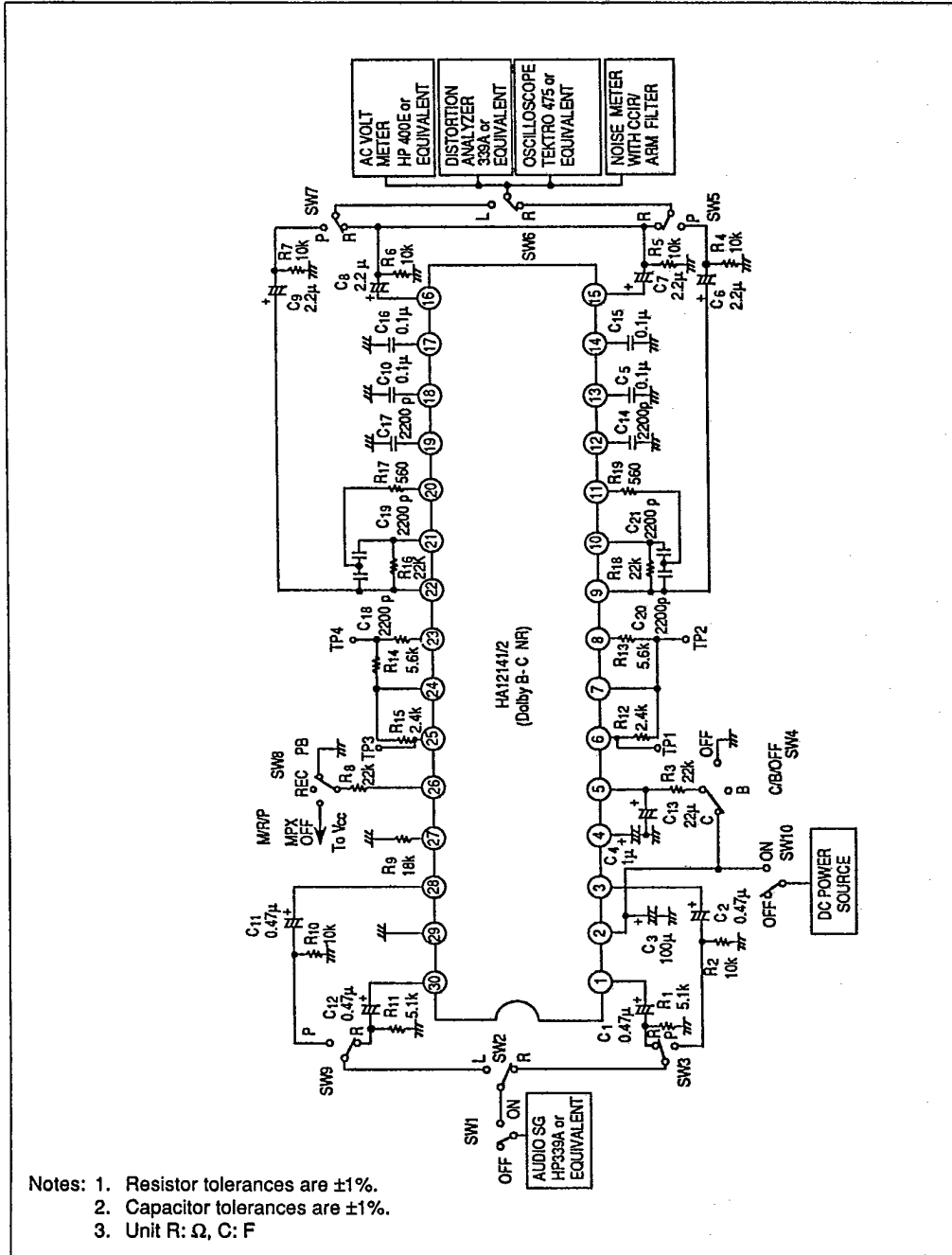

HA12141NT, HA12151MA, HA12161FP, HA12142NT, HA12153MA, HA12162FP

Test Circuit - HA12161FP, HA12162FP

T-77-21

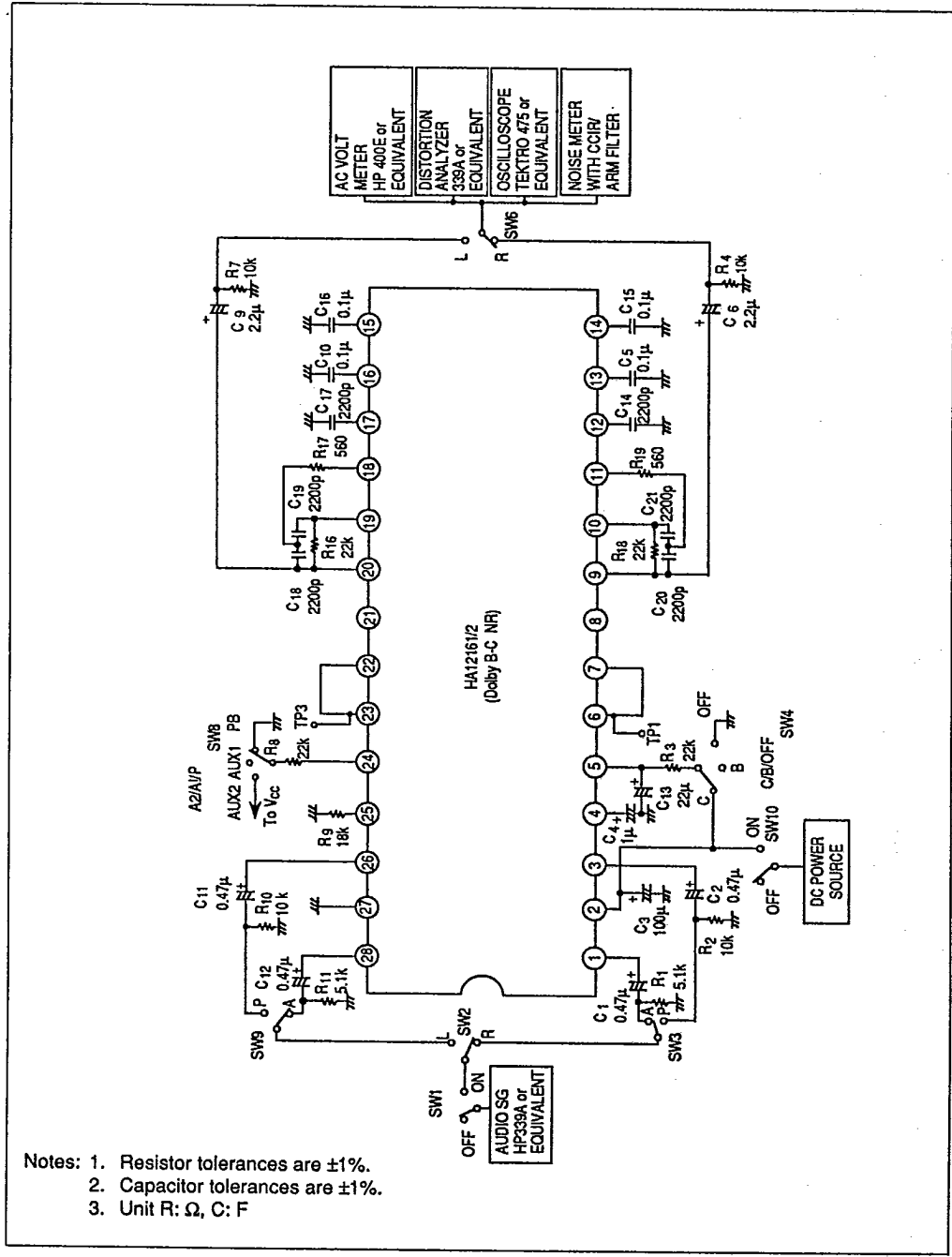

- Notes: 1. Resistor tolerances are $\pm 1\%$.
 2. Capacitor tolerances are $\pm 1\%$.
 3. Unit R: Ω , C: F



HA12141NT, HA12151MA, HA12161FP, HA12142NT, HA12153MA, HA12162FP

HA12134A Series, HA12141 Series Connection Diagram

T-77-21

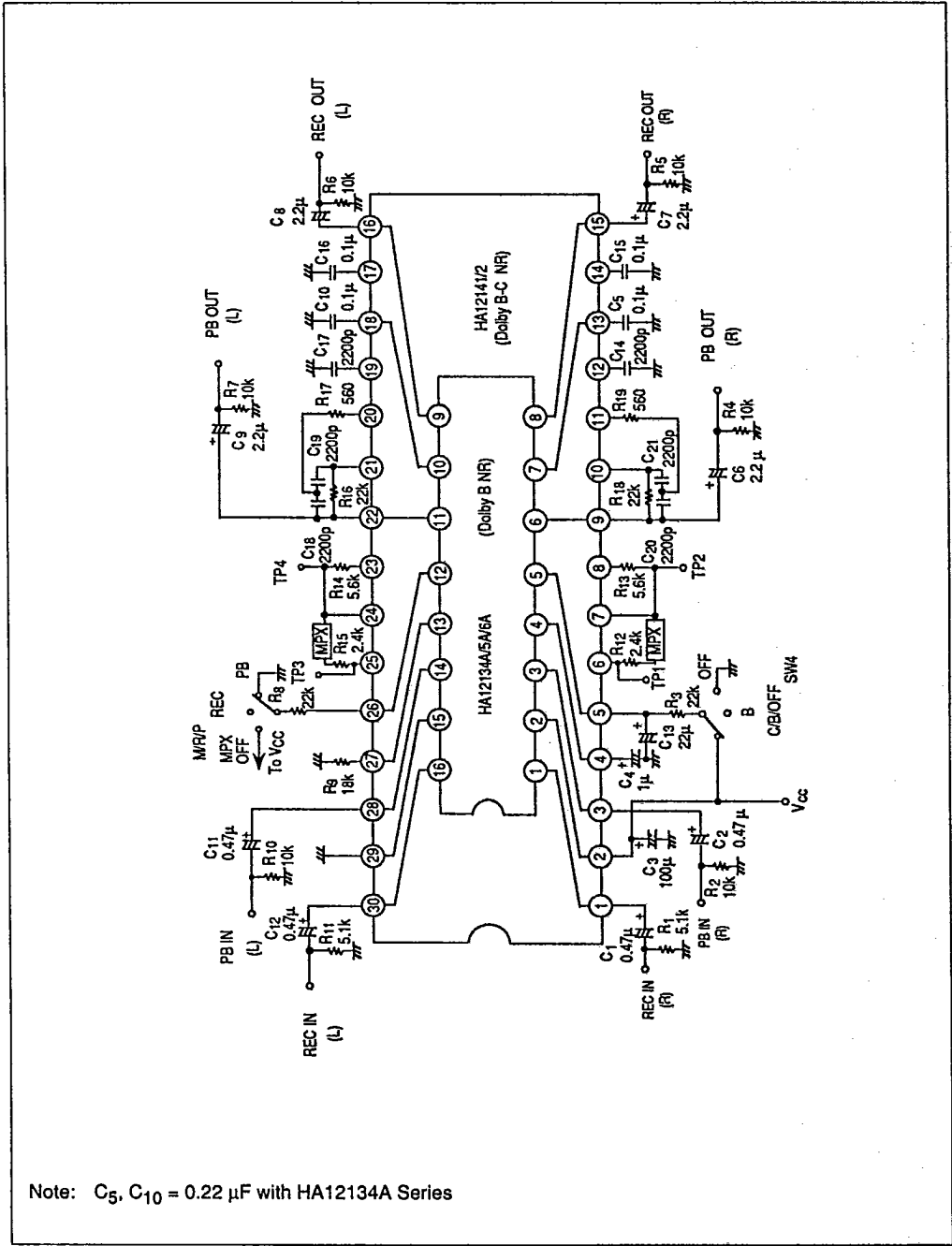

Note: C₅, C₁₀ = 0.22 μF with HA12134A Series



HA12141NT, HA12151MA, HA12161FP, HA12142NT, HA12153MA, HA12162FP

Table 5 Pin Description

$V_{CC} = 12V, T_a = 25^\circ C$, No signal, The value in the table show typical value.

T-77-21

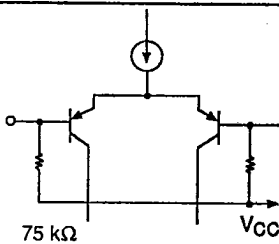
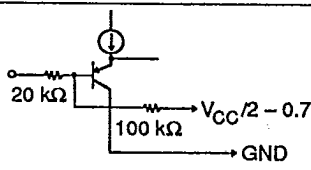
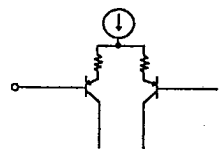
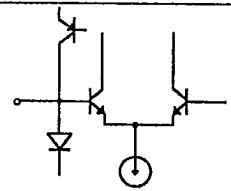
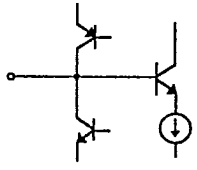
Pin No.			Terminal Name	Zin	DC Voltage	Equivalent Circuit	Description
DP	MSP	SOP					
1	2	1	REC IN	75 kΩ	$V_{CC}/2$		Recording input
30	44	28					
3	5	3	PB IN				Playback input
28	41	26					
2	3	2	V_{CC}	—	V_{CC}	—	Power supply
	4	4					
4	6	4	REF	—	$V_{CC}/2$	—	Ripple filter
5	7	5	C/B/OFF	—	$V_{CC}/2 - 0.7 V$		Mode control pin for NR "H"→C "M"→B "L"→NR OFF
7	10	7	NR IN	—	$V_{CC}/2$		NR processor Input
24	36	22					
10	15	10	SS 1	—	$V_{CC}/2$		Spectral skewing amp input
21	31	19					
12	18	12	CCR	—	$V_{CC}/2$		Current controlled resistor output
19	28	17					



HA12141NT, HA12151MA, HA12161FP, HA12142NT, HA12153MA, HA12162FP

Pin Description (cont)

V_{CC} = 12V, T_a = 25°C, No signal, The value in the table show typical value.

T-77-21

Pin No.			Terminal Name	Z _{in}	DC Voltage	Equivalent Circuit	Description
DP	MSP	SOP					
6	9	6	IA OUT	—	V _{CC} /2		Input amp output
25	37	23					
8	12	8	VREF				Reference Voltage output
23	34	21					
9	14	9	PB OUT				Playback (Decode) output
22	32	20					
11	17	11	SS 2				Spectral skewing amp output
20	29	18					
15	22	—	REC OUT				Recording (Encode) output
16	24	—					
13	19	13	HLS DET	—	2.1 V		Time constant pin for rectifier
18	27	16					
14	20	14	LLS DET				
17	26	15					
26	38 39	24	M/R/P	—	2.1 V		Mode control pin for REC/PB "H" → REC MPX OFF "M" → REC MPX ON "L" → PB
27	40	25	BIAS	—	0.24 V		Reference current input
29	42 43	27	GND	—	0.0 V		Ground



HA12141NT, HA12151MA, HA12161FP, HA12142NT, HA12153MA, HA12162FP

Pin Description (cont)

V_{CC} = 12V, T_a = 25°C, No signal, The value in the table show typical value.

T-77-21

Pin No.

DP	MSP	SOP	Terminal Name	Zin	DC Voltage	Equivalent Circuit	Description
—	1	—	NC	—	—	—	No connection
	11						
	13						
	16						
	21						
	23						
	25						
	30						
	33						
	35						



HA12141NT, HA12151MA, HA12161FP, HA12142NT, HA12153MA, HA12162FP

T-77-21

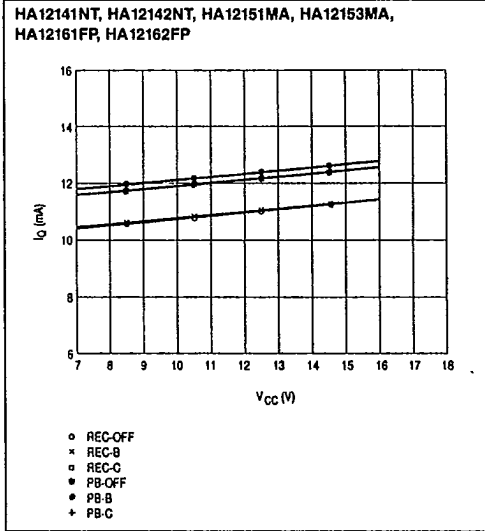

Quiescent Current vs. Supply Voltage

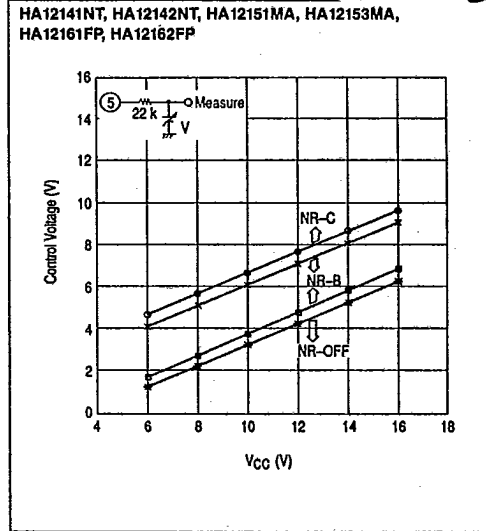

Control Voltage vs. Supply Voltage (NR-OFF/B/C)

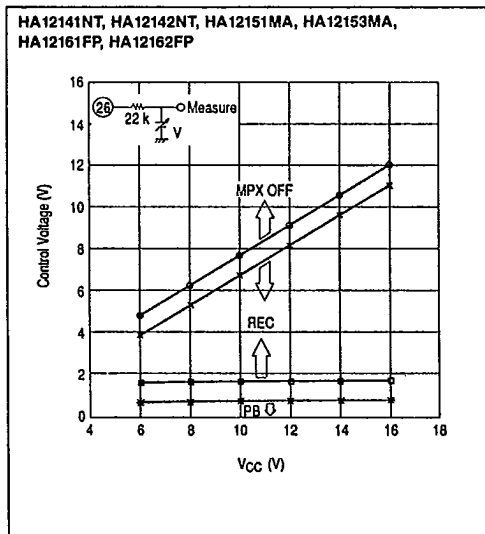

Control Voltage vs. Supply Voltage (PB/REC/MPX)

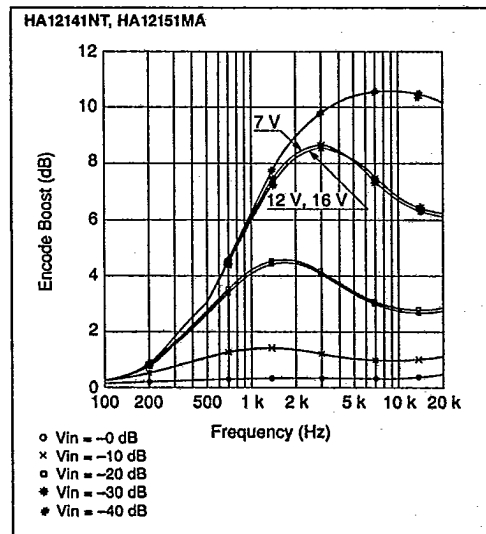

Encode Boost vs. Frequency (NR-B VCC = 7 V, 12 V, 16 V)



HA12141NT, HA12151MA, HA12161FP, HA12142NT, HA12153MA, HA12162FP

T-77-21

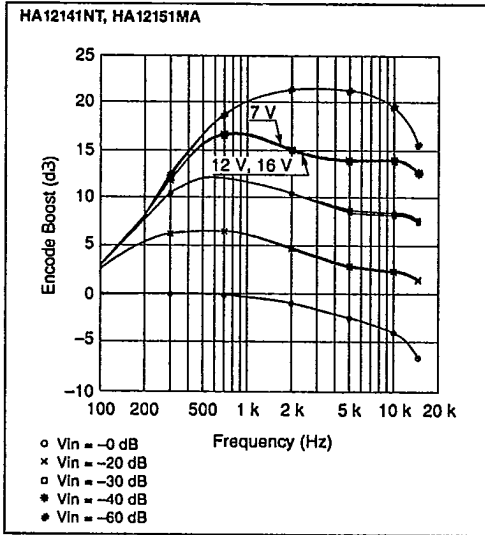

Encode Boost vs. Frequency
(NR-C VCC = 7 V, 12 V, 16 V)

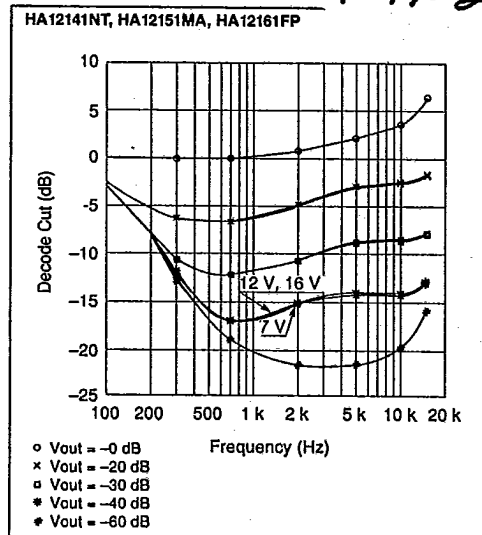

Decode Cut vs. Frequency
(NR-C VCC = 7 V, 12 V, 16 V)

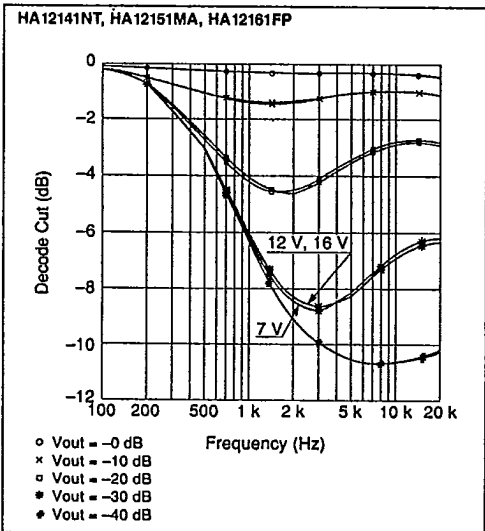

Decode Cut vs. Frequency
(NR-B VCC = 7 V, 12 V, 16 V)

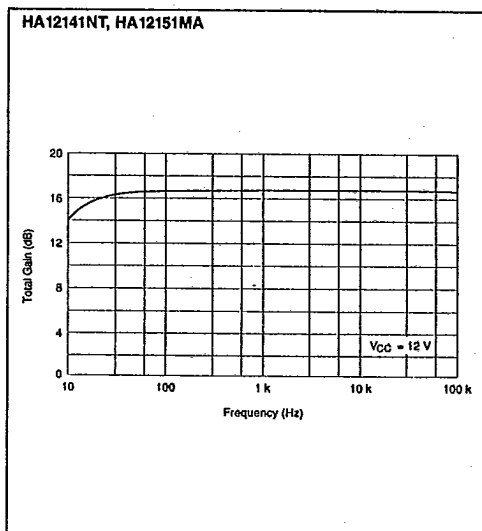

Total Gain vs. Frequency
(REC MODE RECOU NR-OFF)



HA12141NT, HA12151MA, HA12161FP, HA12142NT, HA12153MA, HA12162FP

T-77-21

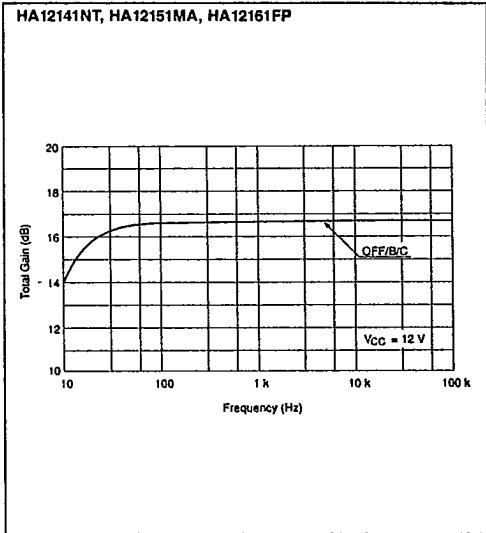

**Total Gain vs. Frequency
(REC MODE PBOUT)**

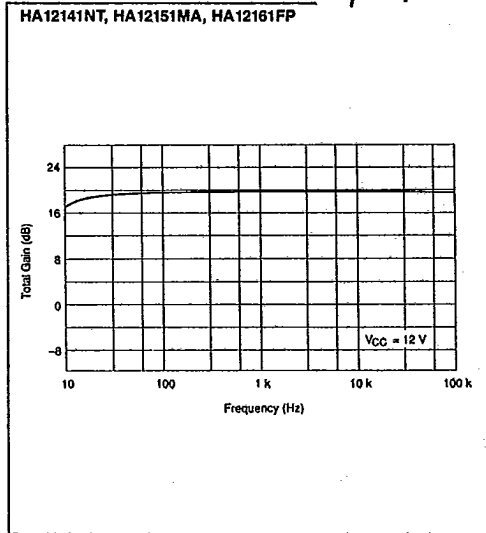

**Total Gain vs. Frequency
(PB MODE PBOUT NR-OFF)**

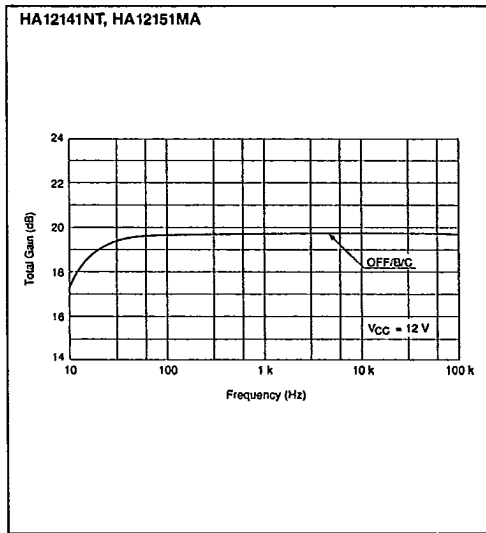

**Total Gain vs. Frequency
(PB MODE RECOUT)**

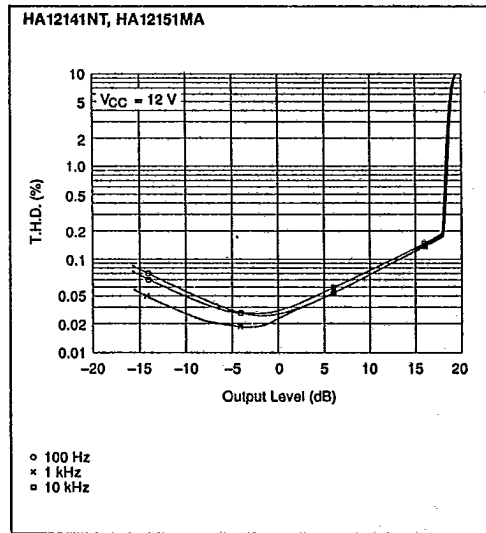

**Total Harmonic Distortion vs. Output Level
(REC MODE NR-OFF)**



HA12141NT, HA12151MA, HA12161FP, HA12142NT, HA12153MA, HA12162FP

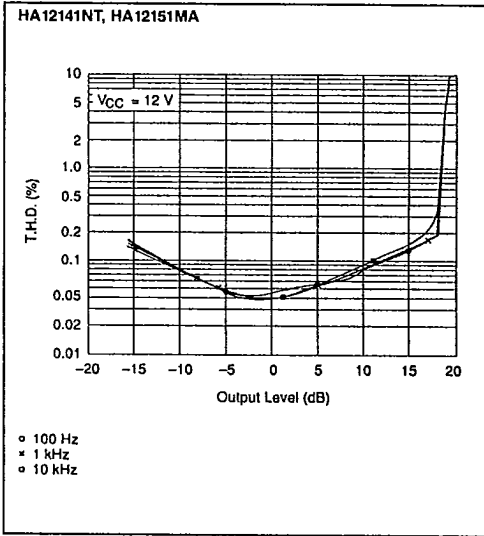

Total Harmonic Distortion vs. Output Level
(REC MODE NR-B)

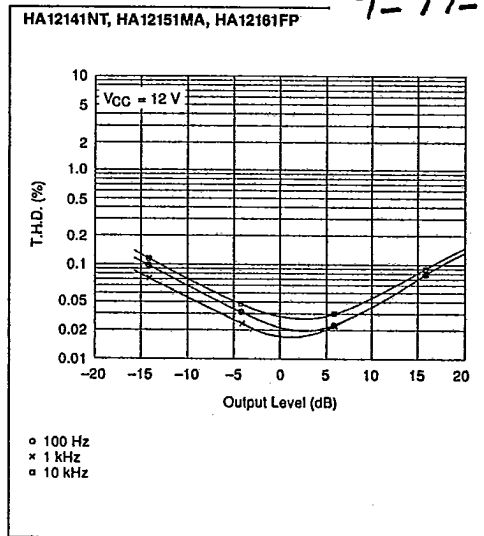

Total Harmonic Distortion vs. Output Level
(PB MODE NR-OFF)

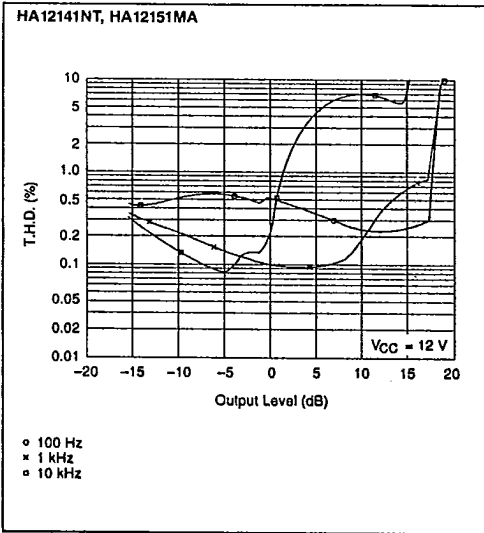

Total Harmonic Distortion vs. Output Level
(REC MODE NR-C)

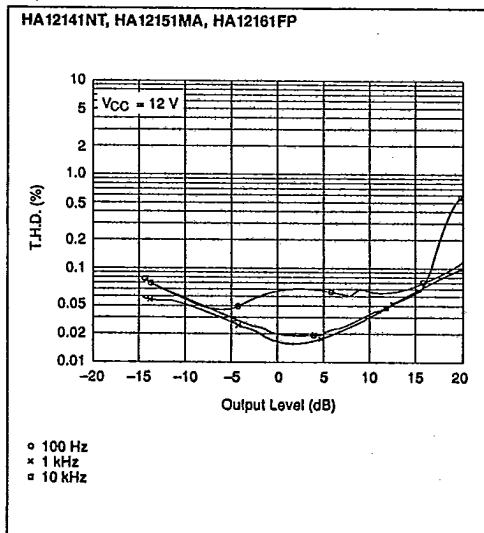

Total Harmonic Distortion vs. Output Level
(PB MODE NR-B)



HA12141NT, HA12151MA, HA12161FP, HA12142NT, HA12153MA, HA12162FP

T-77-21

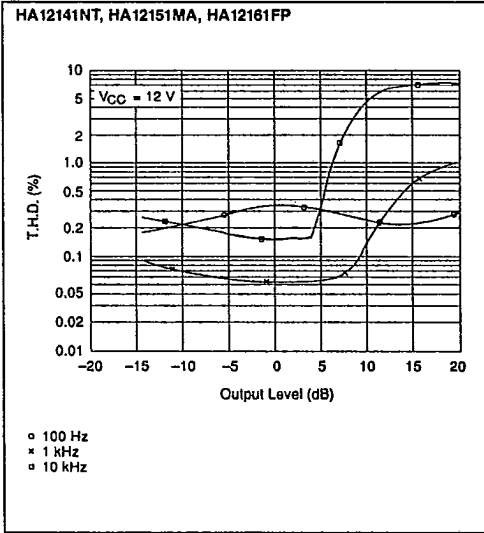

Total Harmonic Distortion vs. Output Level (PB MODE NR-C)

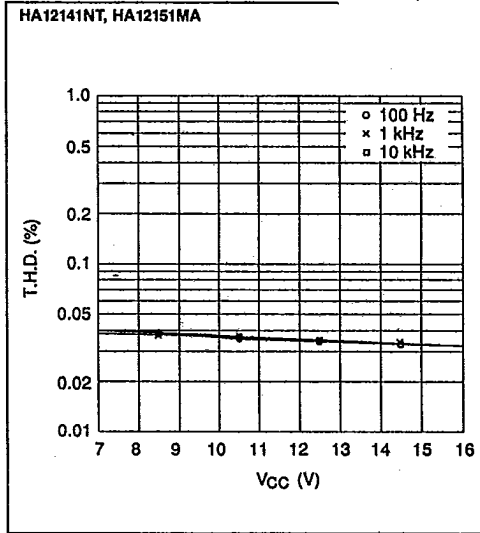

Total Harmonic Distortion vs. Supply Voltage (REC MODE NR-B)

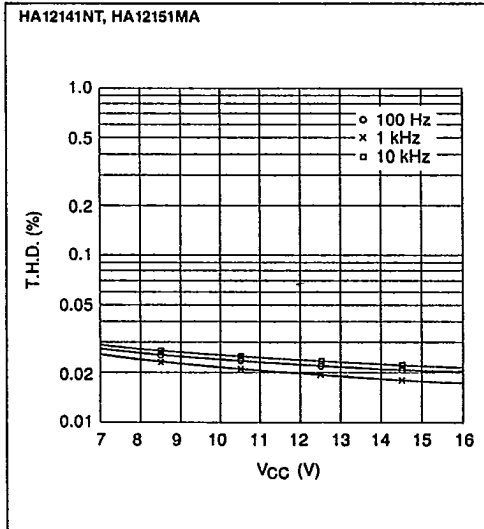

Total Harmonic Distortion vs. Supply Voltage (REC MODE NR-OFF)

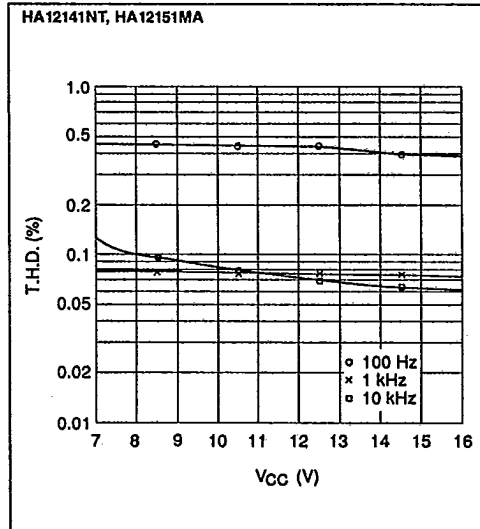

Total Harmonic Distortion vs. Supply Voltage (REC MODE NR-C)



HA12141NT, HA12151MA, HA12161FP, HA12142NT, HA12153MA, HA12162FP

T-77-21

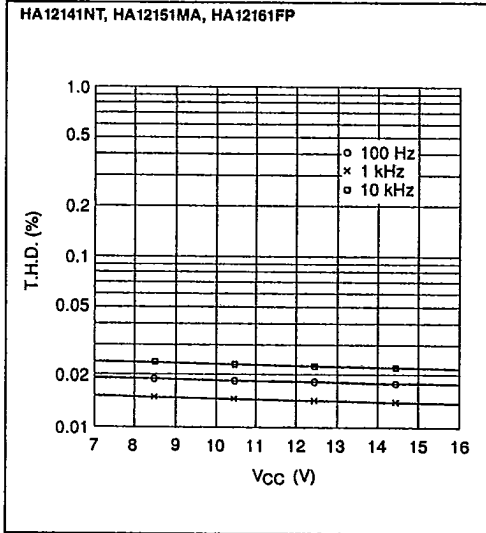

Total Harmonic Distortion vs. Supply Voltage (PB MODE NR-OFF)

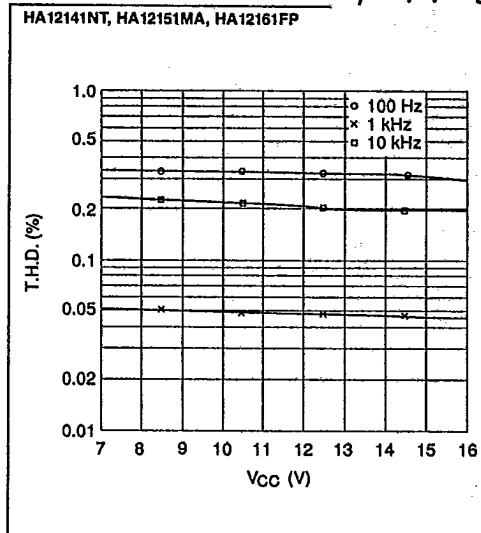

Total Harmonic Distortion vs. Supply Voltage (PB MODE NR-C)

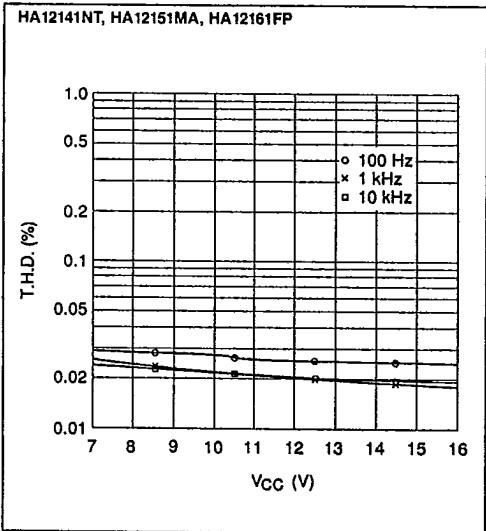

Total Harmonic Distortion vs. Supply Voltage (PB MODE NR-B)

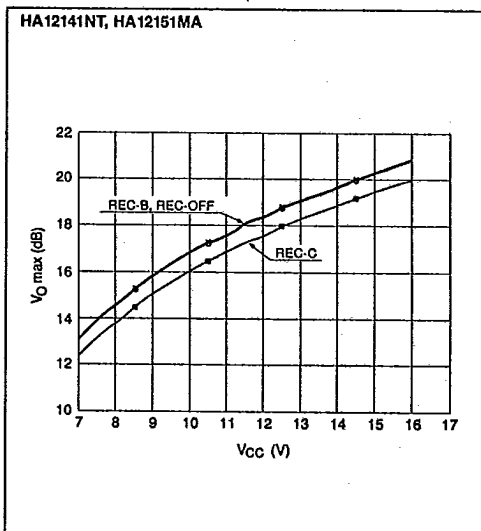

Maximum Output Level vs. Supply Voltage (REC MODE)



HA12141NT, HA12151MA, HA12161FP

T-77-21

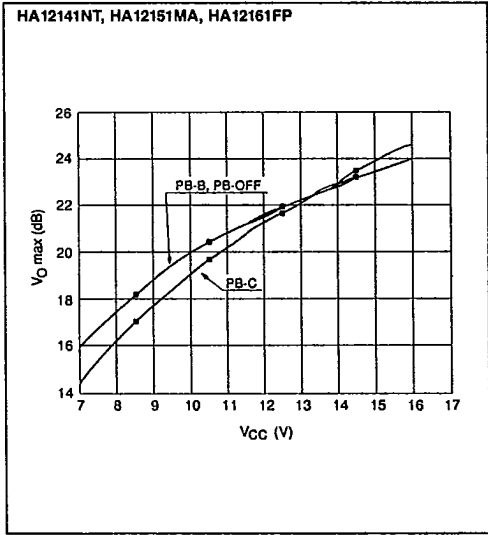

Maximum Output Level vs. Supply Voltage (PB MODE)

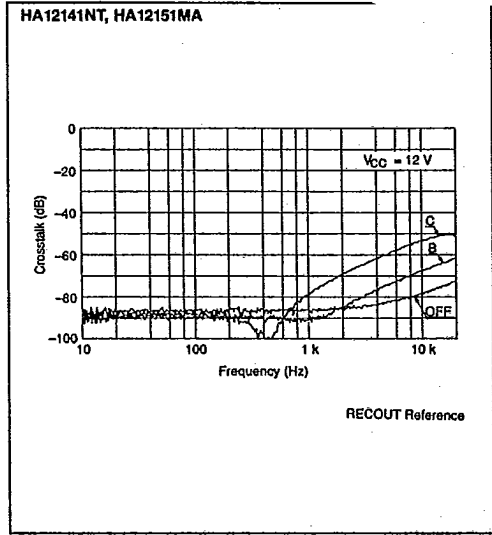

Crosstalk vs. Frequency (REC MODE R ↔ L)

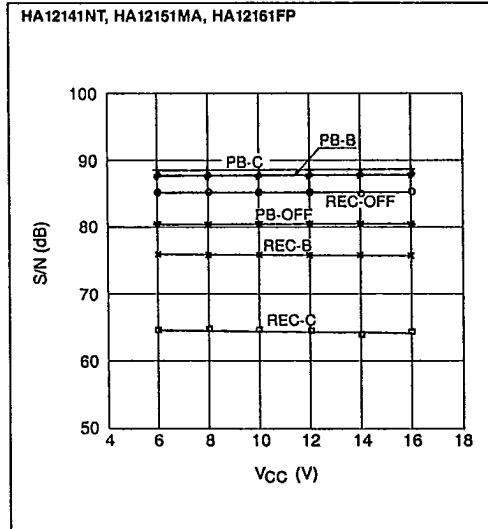

S/N vs. Supply Voltage

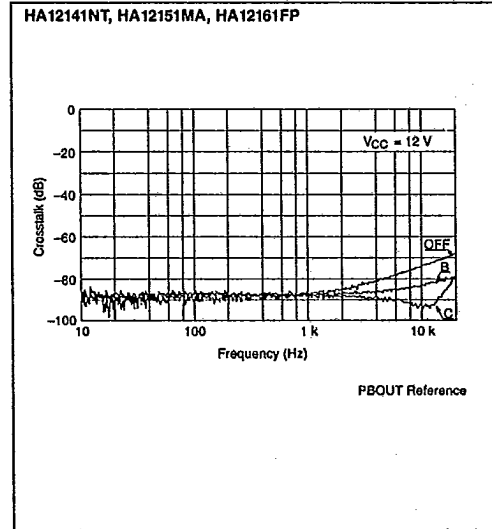

Crosstalk vs. Frequency (PB MODE R ↔ L)



HA12141NT, HA12151MA, HA12161FP, HA12142NT, HA12153MA, HA12162FP

T-77-21

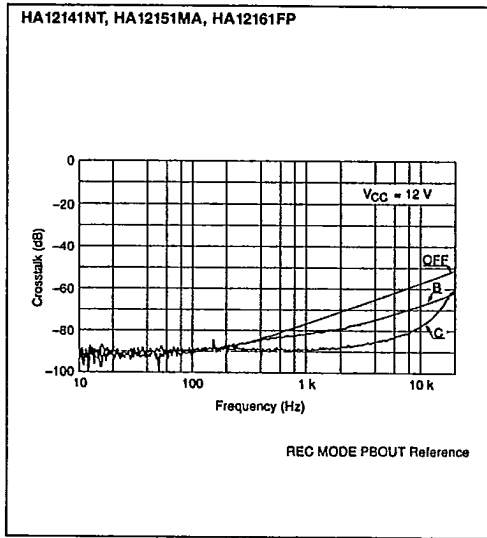

Crosstalk vs. Frequency (REC → PB)

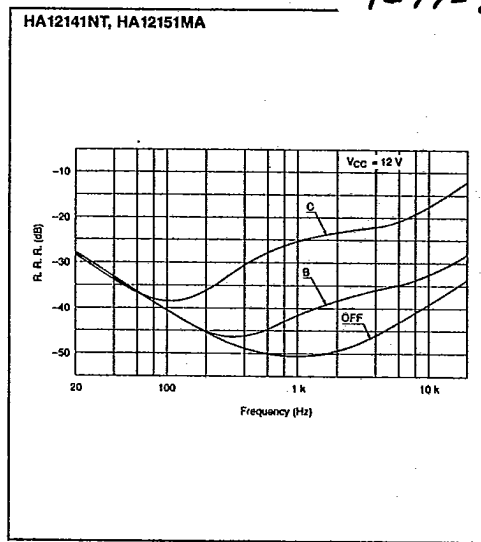

Ripple Rejection Ratio vs. Frequency (REC MODE RECOUT)

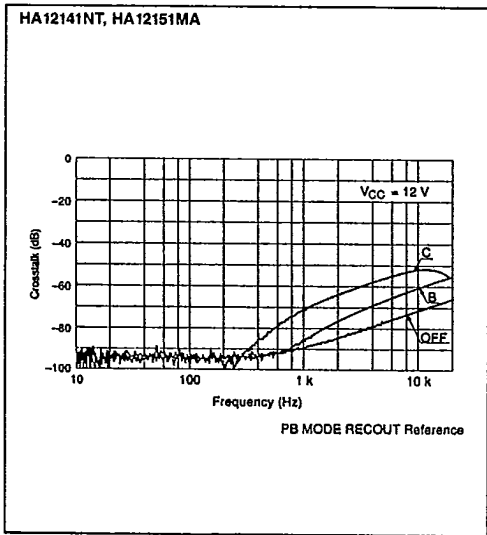

Crosstalk vs. Frequency (PB → REC)

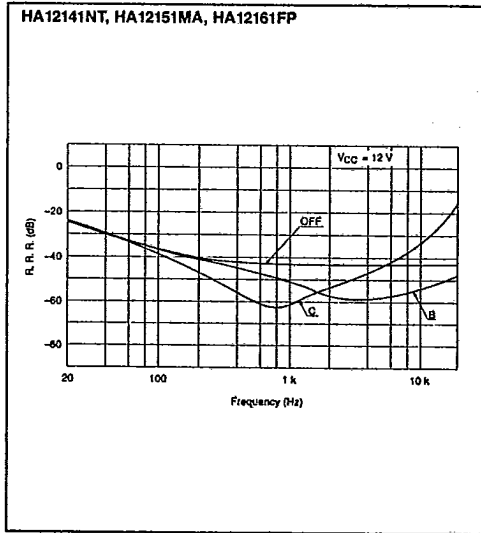

Ripple Rejection Ratio vs. Frequency (PB MODE PBOUT)



HA12141NT, HA12151MA, HA12161FP, HA12142NT, HA12153MA, HA12162FP

T-77-21

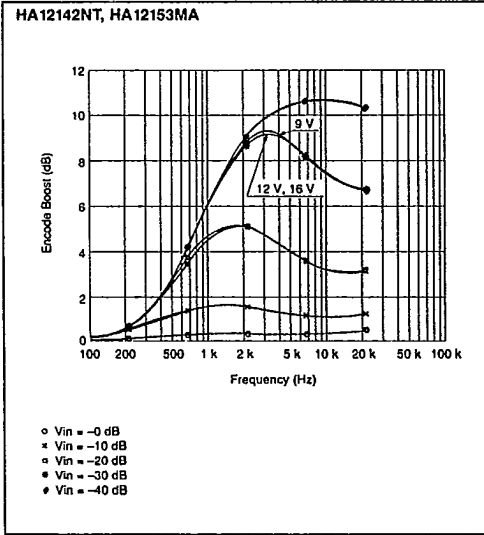

Encode Boost vs. Frequency
(NR-B, VCC = 9 V, 12 V, 16 V)

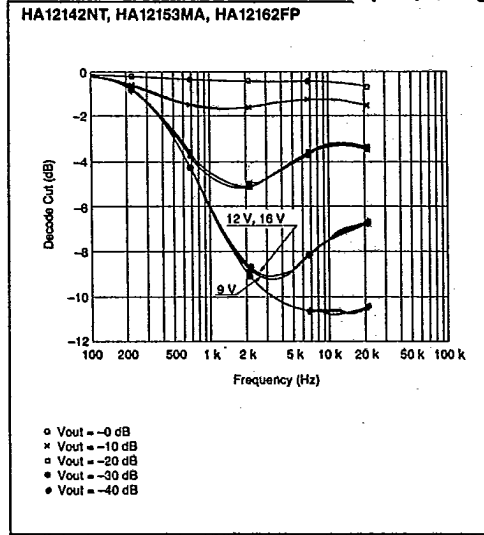

Decode Cut vs. Frequency
(NR-B, VCC = 9 V, 12 V, 16 V)

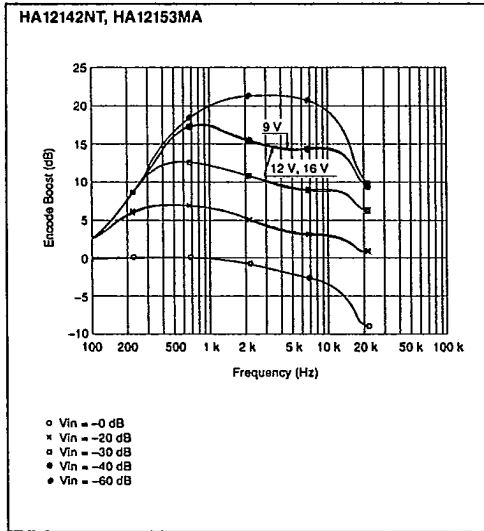

Encode Boost vs. Frequency
(NR-C, VCC = 9 V, 12 V, 16 V)

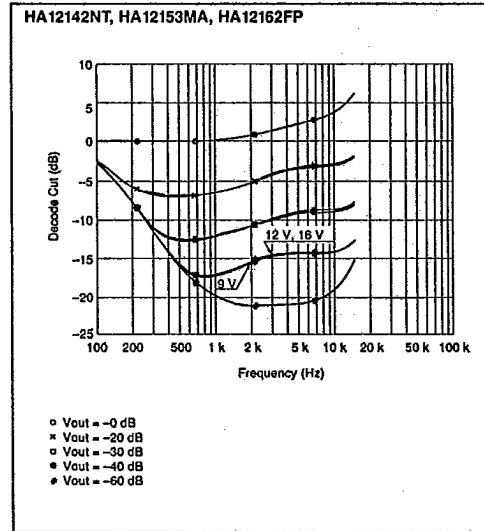

Decode Cut vs. Frequency
(NR-C, VCC = 9 V, 12 V, 16 V)



HA12141NT, HA12151MA, HA12161FP, HA12142NT, HA12153MA, HA12162FP

T-77-21

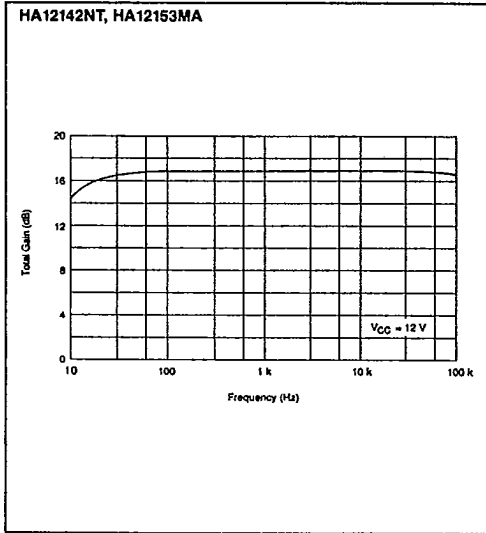

**Total Gain vs. Frequency
(REC MODE RECOU NR-OFF)**

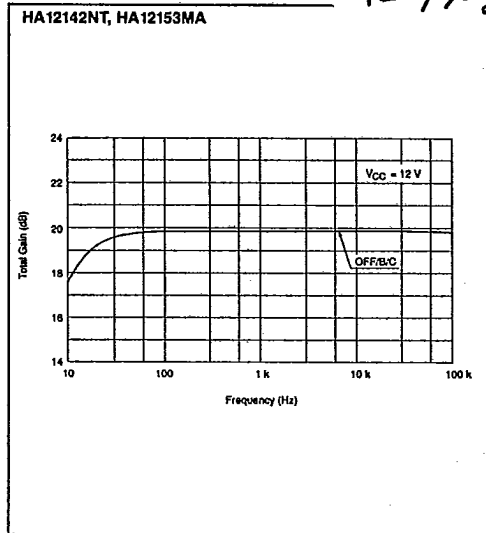

**Total Gain vs. Frequency
(PB MODE RECOU)**

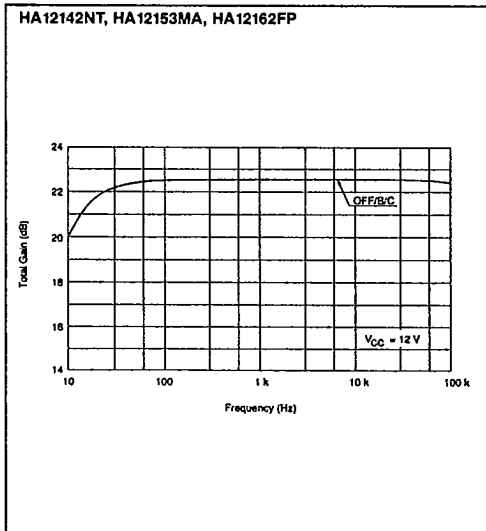

**Total Gain vs. Frequency
(REC MODE PBOUT)**

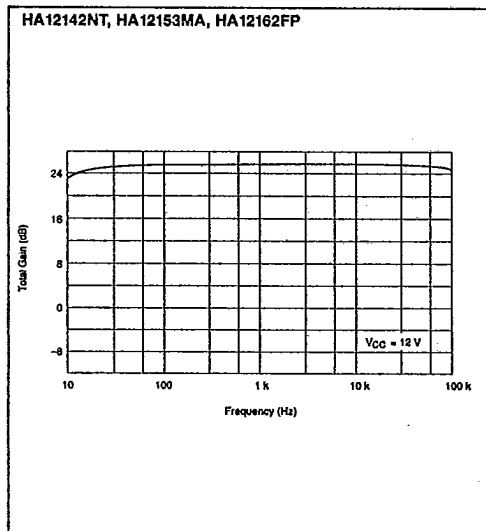

**Total Gain vs. Frequency
(PB MODE PBOUT NR-OFF)**



HA12141NT, HA12151MA, HA12161FP, HA12142NT, HA12153MA, HA12162FP

T-77-21

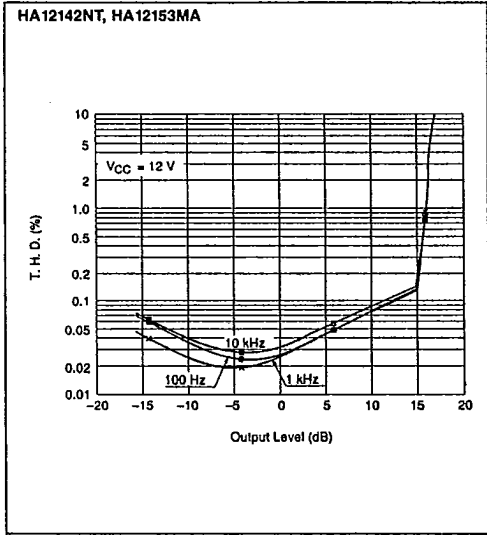

Total Harmonic Distortion vs. Output Level
(REC MODE NR-OFF)

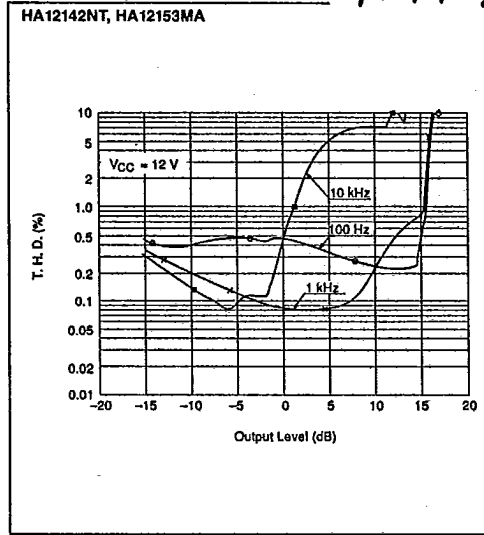

Total Harmonic Distortion vs. Output Level
(REC MODE NR-C)

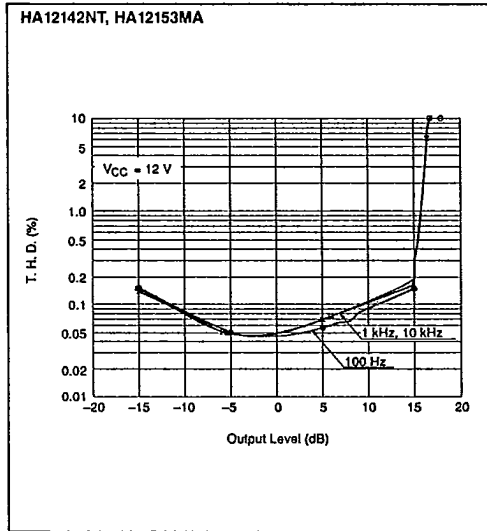

Total Harmonic Distortion vs. Output Level
(REC MODE NR-B)

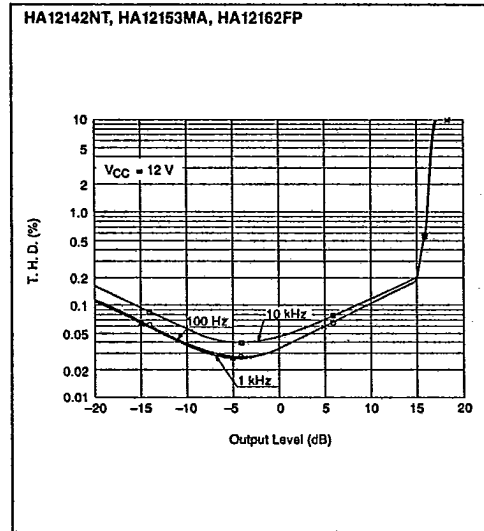

Total Harmonic Distortion vs. Output Level
(PB MODE NR-OFF)



HA12141NT, HA12151MA, HA12161FP, HA12142NT, HA12153MA, HA12162FP

T-77-21

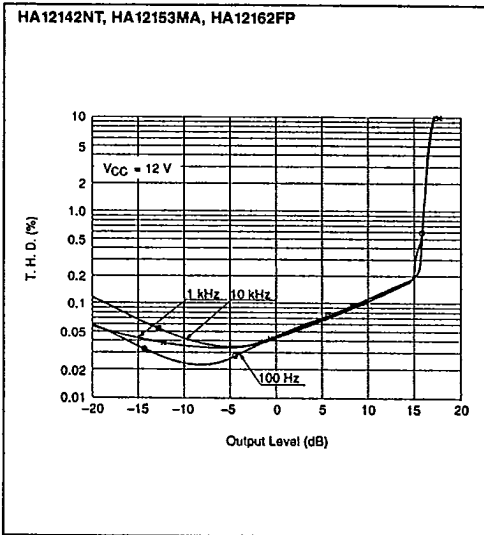

Total Harmonic Distortion vs. Output Level (PB MODE NR-B)

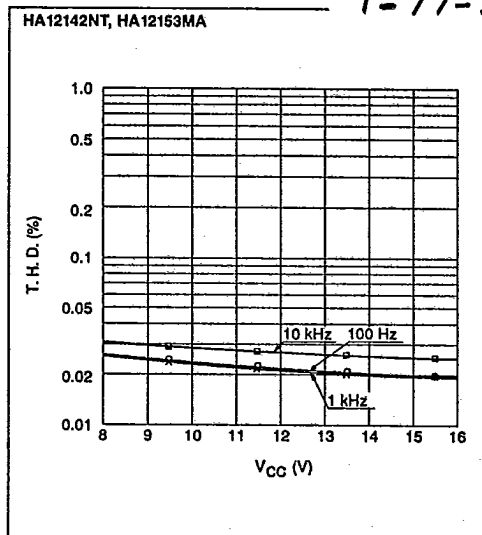

Total Harmonic Distortion vs. Supply Voltage (REC MODE NR-OFF)

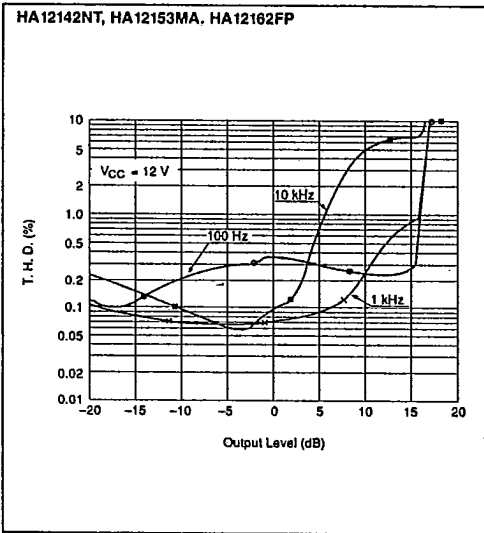

Total Harmonic Distortion vs. Output Level (PB MODE NR-C)

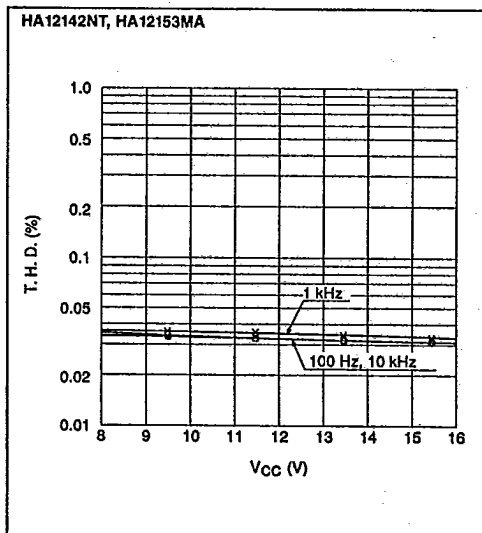

Total Harmonic Distortion vs. Supply Voltage (REC MODE NR-B)



HA12141NT, HA12151MA, HA12161FP, HA12142NT, HA12153MA, HA12162FP

T-77-21

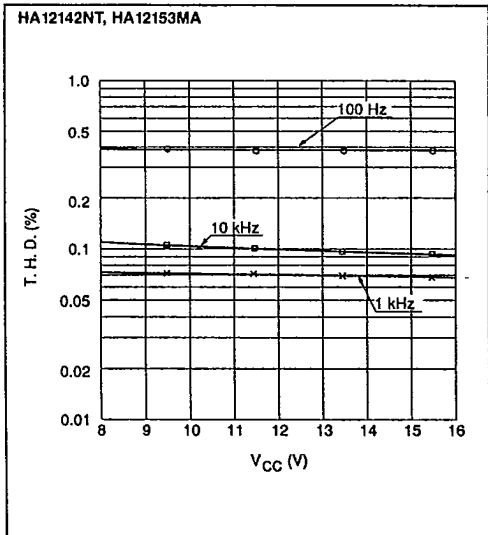

Total Harmonic Distortion vs. Supply Voltage (REC MODE NR-C)

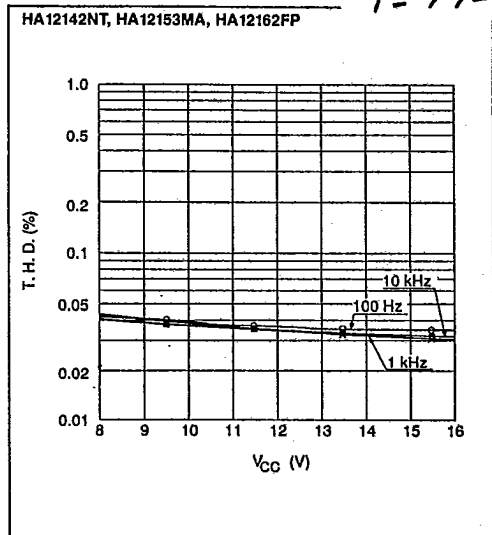

Total Harmonic Distortion vs. Supply Voltage (PB MODE NR-B)

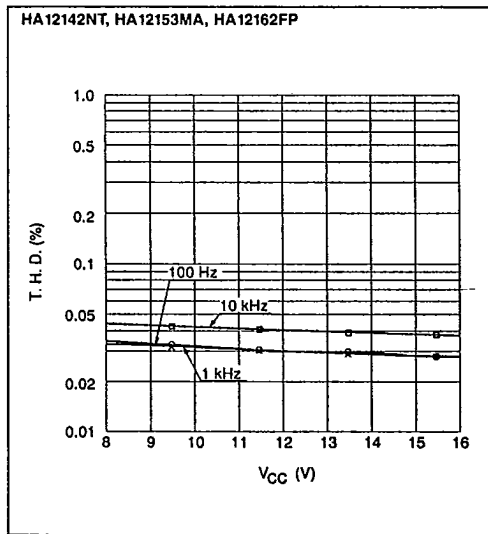

Total Harmonic Distortion vs. Supply Voltage (PB MODE NR-OFF)

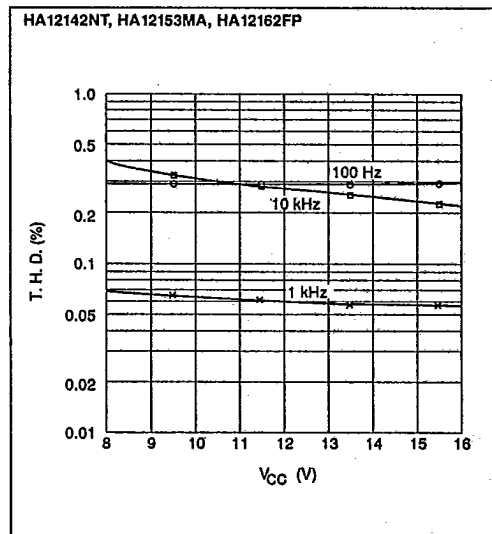

Total Harmonic Distortion vs. Supply Voltage (PB MODE NR-C)



HA12141NT, HA12151MA, HA12161FP, HA12142NT, HA12153MA, HA12162FP

T-77-21

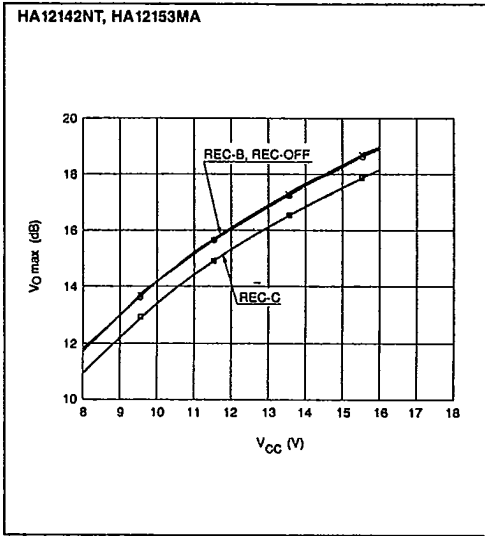

Maximum Output Level vs. Supply Voltage (REC MODE)

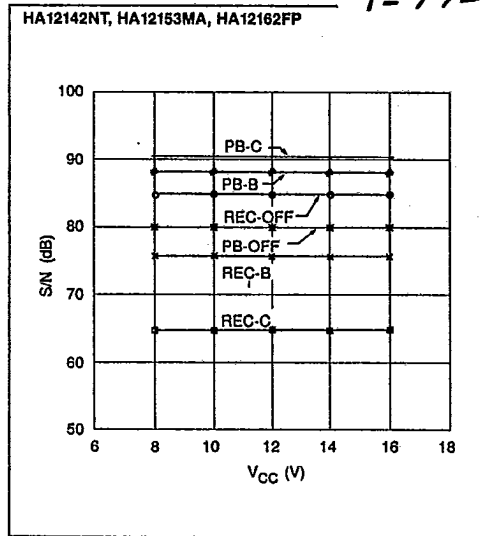

S/N vs. Supply Voltage

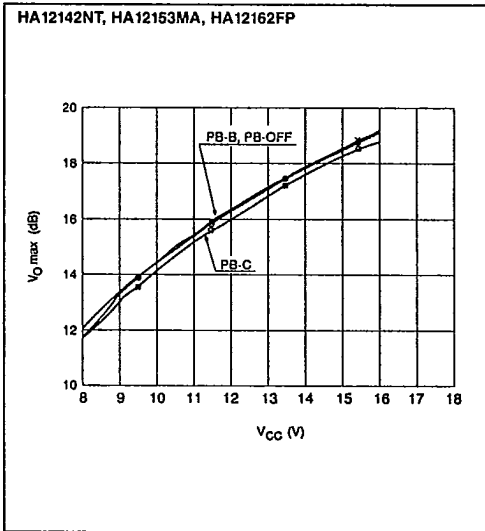

Maximum Output Level vs. Supply Voltage (PB MODE)

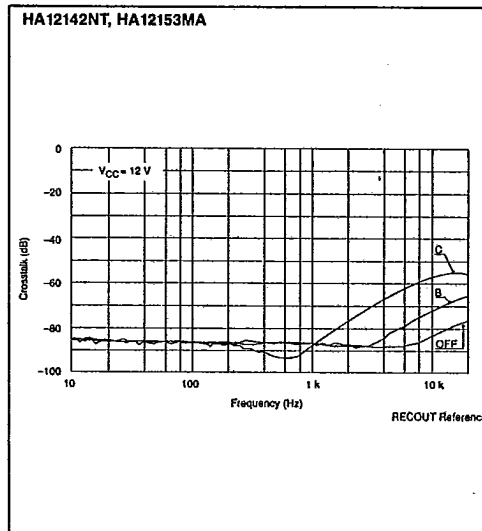

Crosstalk vs. Frequency (REC MODE R ↔ L)



HA12141NT, HA12151MA, HA12161FP, HA12142NT, HA12153MA, HA12162FP

T-77-21

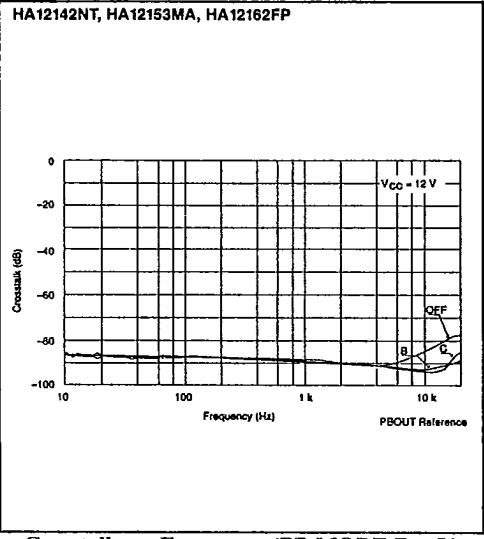

Crosstalk vs. Frequency (PB MODE R ↔ L)

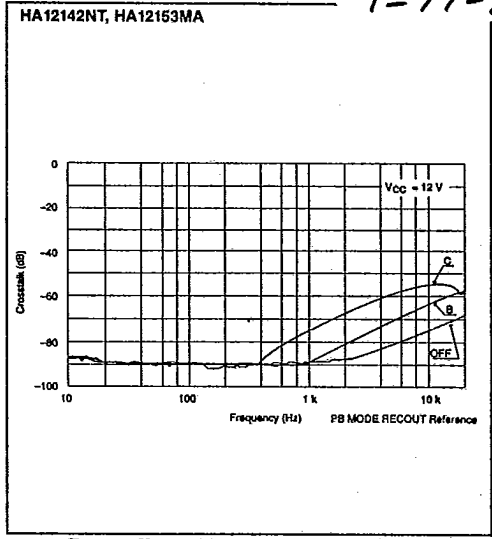

Crosstalk vs. Frequency (PB → REC)

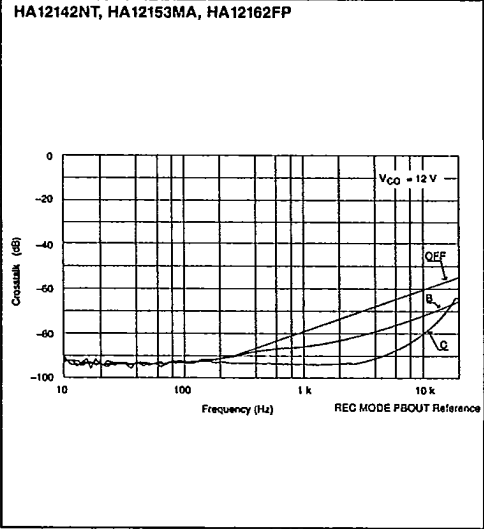

Crosstalk vs. Frequency (REC → PB)

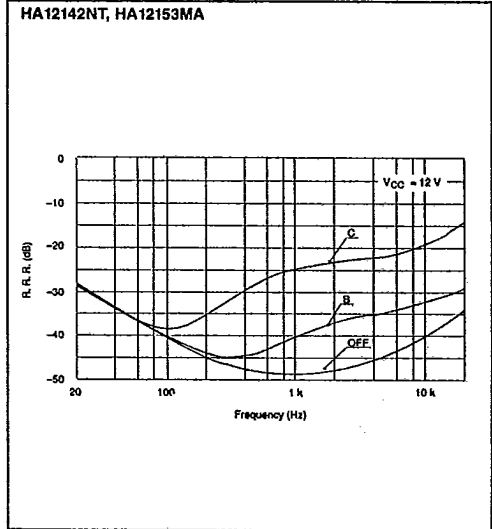

Ripple Rejection Ratio vs. Frequency (REC MODE RECOUT)



HA12141NT, HA12151MA, HA12161FP, HA12142NT, HA12153MA, HA12162FP

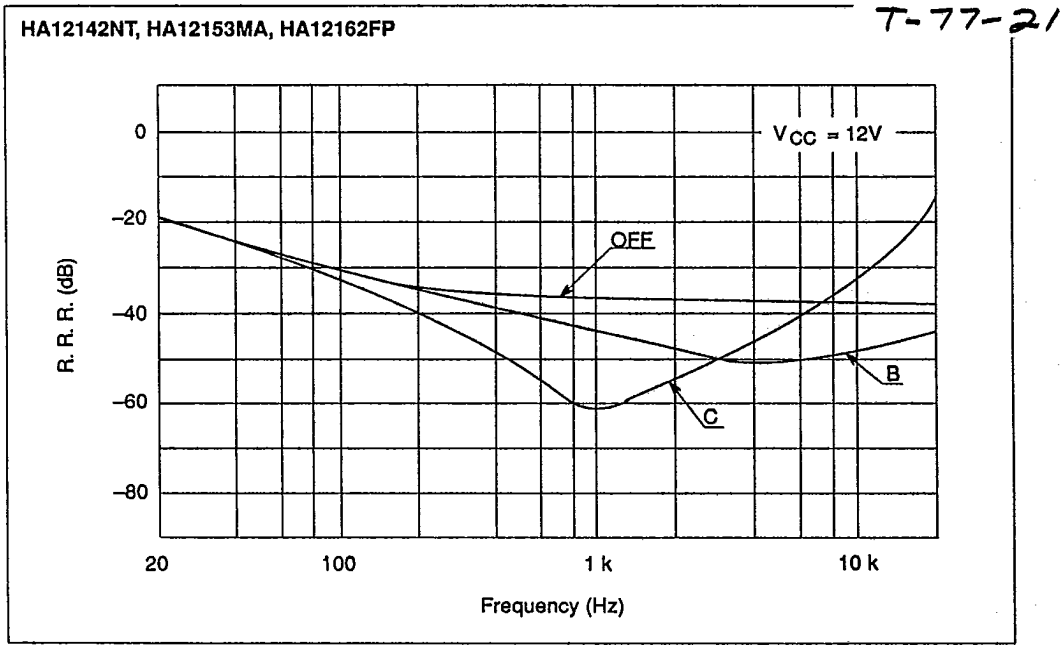

Ripple Rejection Ratio vs. Frequency (PB MODE PBOU)



HA12141NT, HA12151MA, HA12161FP, HA12142NT, HA12153MA, HA12162FP

T-77-21

Application Note

Power Supply Range

HA12141 series are designed to operate on either single supply or split supply.

The Operating range of the supply voltage is shown in table 1.

The lower limit of supply voltage depends on the line output reference level.

The minimum value of the overload margin is specified as 12 dB by Dolby Laboratories.

HA12141 series are provided with two line output level, which will permit an optimum overload margin for power supply conditions.

Table 1 Supply Voltage

Type No.	Single supply	Split supply
HA12141NT HA12151MA HA12161FP	7.5 to 16 V	±3.8 to ±8 V
HA12142NT HA12153MA HA12162FP	9.5 to 16 V	±4.8 to ±8 V

Reference Voltage

For the single supply operation these devices generate the reference voltage of half the supply voltage that is the signal grounds. As the peculiarity of these devices the capacitor for the ripple filter is very small about 1/100 compared with conventional devices.

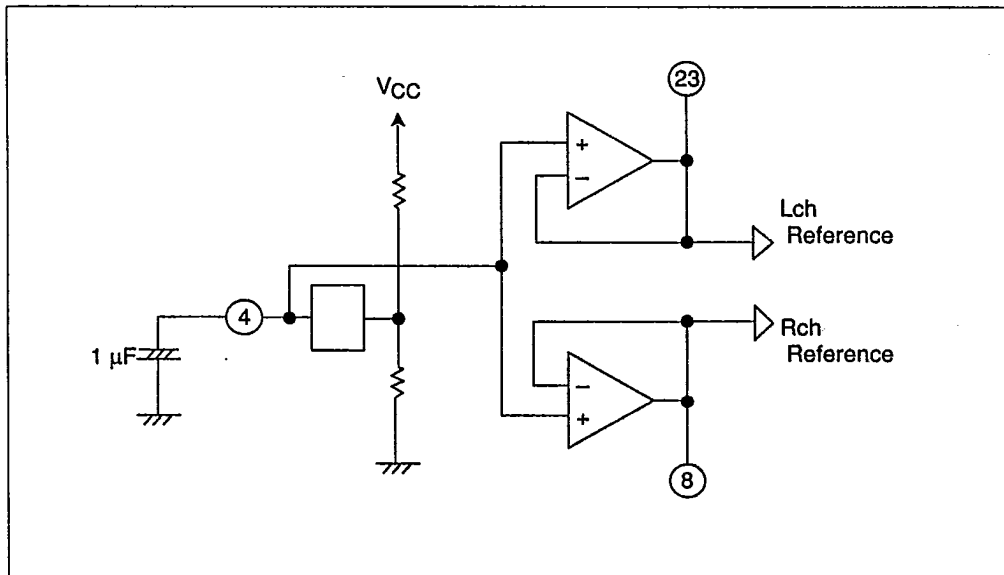

Figure 1 The Block-Diagram of Reference Voltage Supply

The Reference voltage supplies are provided for the left channel and the right channel. The block-diagram is shown as figure 1.



HA12141NT, HA12151MA, HA12161FP, HA12142NT, HA12153MA, HA12162FP

Operation Mode Control

HA12141 series provide fully electronic switching circuits. The function are controlled by DC voltage and are NR OFF/B/C and PB/REC/MPX.

The switching truth tables are shown in table 2 and table 3.

T-77-21
 MPX-off mode means that signal from input amp doesn't go through the MPX filter, but signal goes through the SS circuit after being attenuated 3 dB by internal resistor. Refer to figure 2.

It is to be desired that CR time constant circuits are provided at NR OFF/B/C terminal and PB/REC/MPX terminal with time constant from 0.1 sec to 1 sec. If so, it will reduce the switching click noise effectively.

Table 2 Switching Truth Table (NR OFF/B/C)

Function	Single supply	Split supply	Unit	Note
NR OFF	0 to $\frac{V_{CC}}{2} - 3$	V_{EE} to -3	V	
B type	$\frac{V_{CC}}{2} - 0.5$ to $\frac{V_{CC}}{2} + 0.5$	-0.5 to 0.5	V	*1
C type	$\frac{V_{CC}}{2} + 3$ to V_{CC}	3 to V_{CC}	V	

Table 3 Switching Truth Table (PB/REC/MPX)

Function	Single supply	Split supply	Unit	Note
Play back (Decode mode)	0 to 0.4	V_{EE} to $V_{EE} + 0.4$	V	
Record (Encode mode)	2.5 to $\frac{V_{CC}}{2} + 0.5$	$V_{EE} + 2.5$ to 0.5	V	*1
MPX-OFF	$V_{CC} - 1$ to V_{CC}	$V_{CC} - 1$ to V_{CC}	V	

Note: 1. These functions are available for being open at NR B mode and REC mode.



T-77-21

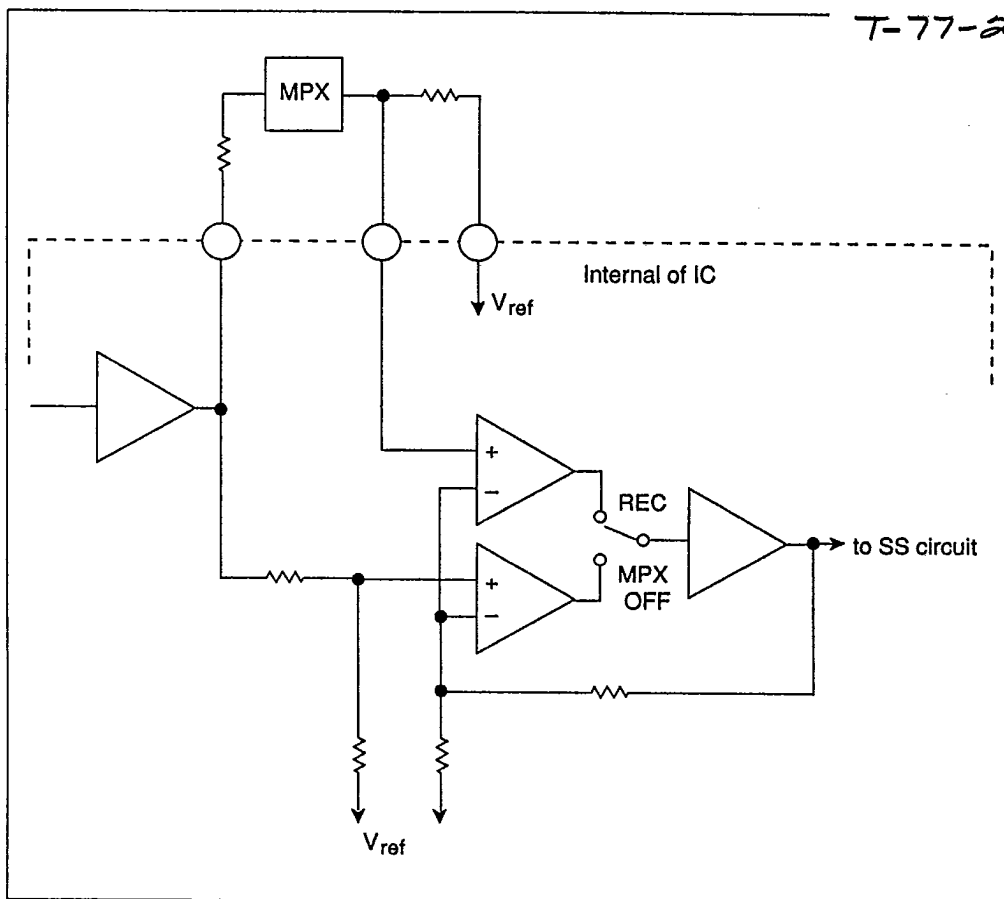

Figure 2 The Block Diagram of MPX Driving Circuit

Application Circuits

HA12161FP/62FP application

HA12161FP/62FP are developed for exclusive playback of car stereo players.

But these devices are provided with AUX input. This application providing AUX input is available for car stereo players and car stereo cassette decks.

AUX input will be useful for a tuner input. In this case PB/REC/MPX switching operates as the switching of PB/AUX1/AUX2.



HA12141NT, HA12151MA, HA12161FP, HA12142NT, HA12153MA, HA12162FP

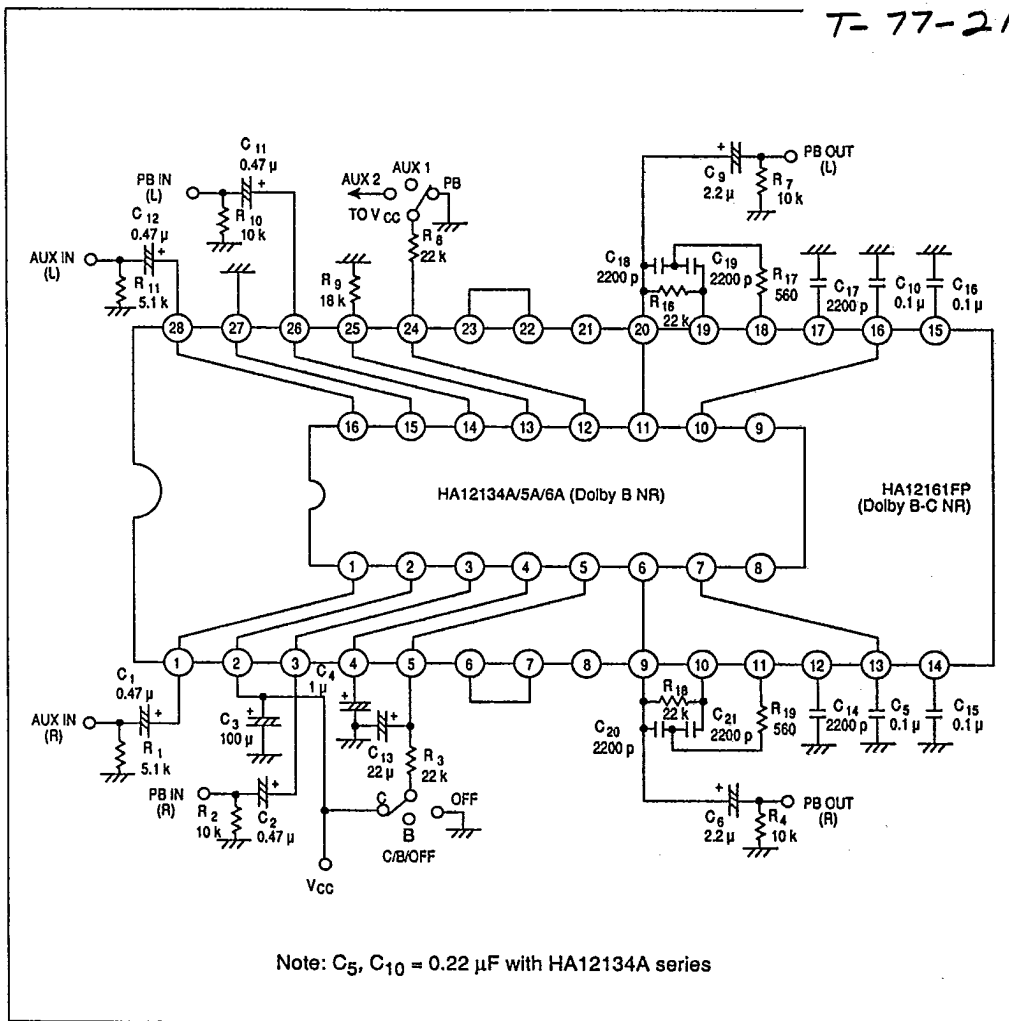

Figure 3 Application of HA12161FP/62FP



HA12141NT, HA12151MA, HA12161FP, HA12142NT, HA12153MA, HA12162FP

We show such application in figure 3. In this application there is 3 dB difference between mode AUX1 and mode AUX2 of controlled terminal's

pin 24. Another application is show in figure 4. It is put in filter circuit between pin 6 or 23 and pin 7 or 22.

T-77-21

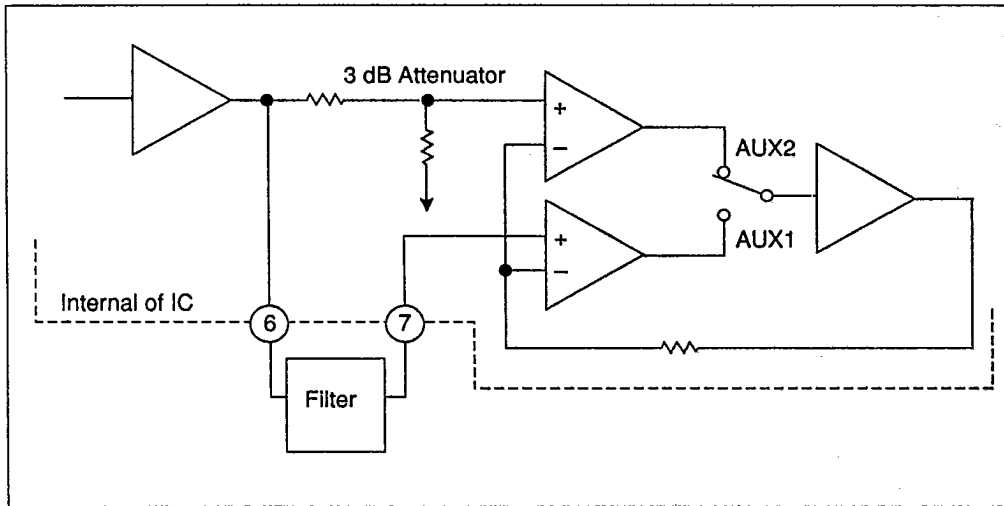

Figure 4 Application of AUX Mode

For example AUX1 mode is AM tuner input and AUX2 mode is FM tuner input respectively.

Encode Decode processor for 3 head cassette deck

HA12151MA and HA12153MA has two control terminals for C/B/off mode and MPX-off/REC/PB mode respectively. So, it is available to select the mode of recording channel or playback channel respectively.



HA12141NT, HA12151MA, HA12161FP, HA12142NT, HA12153MA, HA12162FP

T-77-21

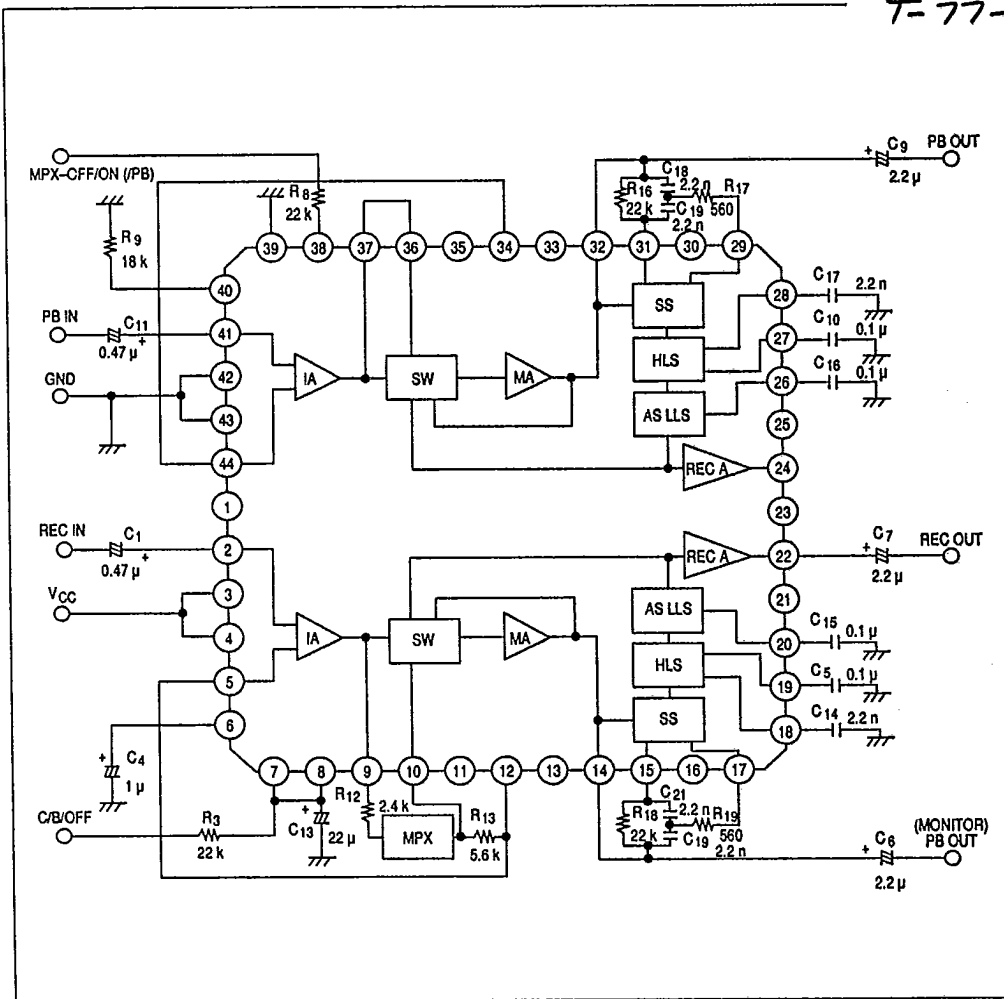

Figure 5 Application of Encode Decode Processor for 3 Head Cassette Deck



Application for dubbing cassette decks

T-77-21

HA12141 series has unprocessor signal from recording out terminals during playback mode. So, it is simply applied for dubbing cassette decks.

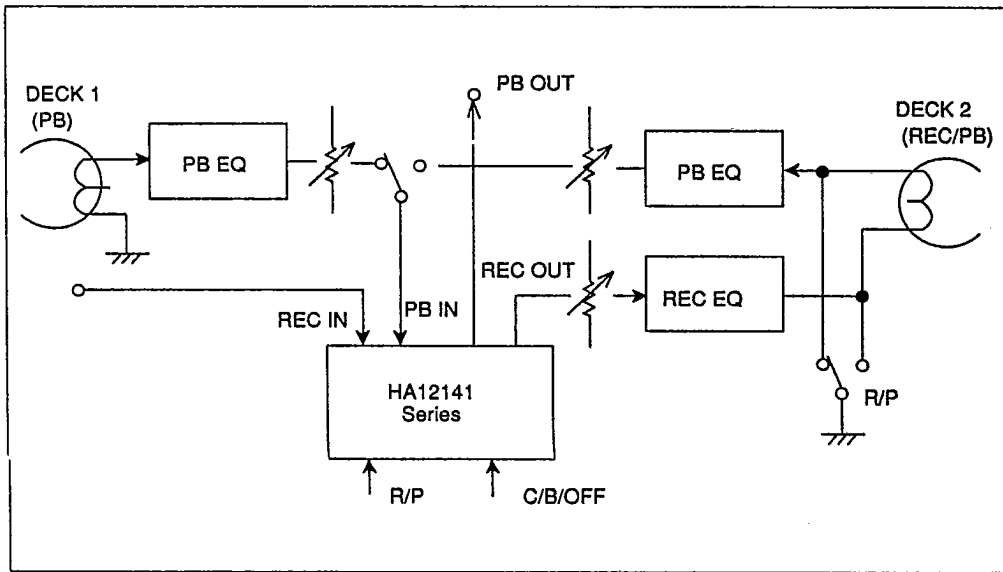

Figure 6 Application for Dubbing Deck

