

P6SMB11CAT3 Series

600 Watt Peak Power Zener Transient Voltage Suppressors Bidirectional*

The SMB series is designed to protect voltage sensitive components from high voltage, high energy transients. They have excellent clamping capability, high surge capability, low zener impedance and fast response time. The SMB series is supplied in ON Semiconductor's exclusive, cost-effective, highly reliable Surmetic™ package and is ideally suited for use in communication systems, automotive, numerical controls, process controls, medical equipment, business machines, power supplies and many other industrial/consumer applications.

Features

- Working Peak Reverse Voltage Range – 9.4 to 77.8 V
- Standard Zener Breakdown Voltage Range – 11 to 91 V
- Peak Power – 600 W @ 1 ms
- ESD Rating of Class 3 (>16 KV) per Human Body Model
- Maximum Clamp Voltage @ Peak Pulse Current
- Low Leakage < 5 µA Above 10 V
- UL 497B for Isolated Loop Circuit Protection
- Response Time is Typically < 1 ns
- Pb-Free Packages are Available

Mechanical Characteristics:

CASE: Void-Free, Transfer-Molded, Thermosetting Plastic

FINISH: All External Surfaces are Corrosion Resistant and Leads are Readily Solderable

MAXIMUM CASE TEMPERATURE FOR SOLDERING PURPOSES: 260°C for 10 Seconds

LEADS: Modified L-Bend Providing More Contact Area to Bond Pads

POLARITY: Polarity Band Will Not be Indicated

MOUNTING POSITION: Any

MAXIMUM RATINGS

Rating	Symbol	Value	Unit
Peak Power Dissipation (Note 1) @ $T_L = 25^\circ\text{C}$, Pulse Width = 1 ms	P_{PK}	600	W
DC Power Dissipation @ $T_L = 75^\circ\text{C}$ Measured Zero Lead Length (Note 2) Derate Above 75°C	P_D	3.0	W
	$R_{\theta JL}$	40 25	mW/°C °C/W
DC Power Dissipation (Note 3) @ $T_A = 25^\circ\text{C}$ Derate Above 25°C	P_D	0.55	W
	$R_{\theta JA}$	4.4 226	mW/°C °C/W
Operating and Storage Temperature Range	T_J, T_{stg}	-65 to +150	°C

Stresses exceeding Maximum Ratings may damage the device. Maximum Ratings are stress ratings only. Functional operation above the Recommended Operating Conditions is not implied. Extended exposure to stresses above the Recommended Operating Conditions may affect device reliability.

1. 10 X 1000 µs, non-repetitive
2. 1" square copper pad, FR-4 board
3. FR-4 board, using ON Semiconductor minimum recommended footprint, as shown in 403A case outline dimensions spec.

*Please see P6SMB6.8AT3 to P6SMB200AT3 for Unidirectional devices.



ON Semiconductor®

<http://onsemi.com>

**PLASTIC SURFACE MOUNT
ZENER OVERVOLTAGE
TRANSIENT SUPPRESSORS
9.4-78 VOLTS
600 WATT PEAK POWER**



**SMB
CASE 403A
PLASTIC**

MARKING DIAGRAM

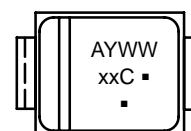

xxC = Device Code

A = Assembly Location

Y = Year

WW = Work Week

▪ = Pb-Free Package

(Note: Microdot may be in either location)

ORDERING INFORMATION

Device	Package	Shipping†
P6SMBxxCAT3	SMB	2500/Tape & Reel
P6SMBxxCAT3G	SMB (Pb-Free)	2500/Tape & Reel

The "T3" suffix refers to a 13 inch reel.

†For information on tape and reel specifications, including part orientation and tape sizes, please refer to our Tape and Reel Packaging Specifications Brochure, BRD8011/D.

Devices listed in **bold, italic** are ON Semiconductor Preferred devices. Preferred devices are recommended choices for future use and best overall value.

P6SMB11CAT3 Series

ELECTRICAL CHARACTERISTICS

(T_A = 25°C unless otherwise noted)

Symbol	Parameter
I _{PP}	Maximum Reverse Peak Pulse Current
V _C	Clamping Voltage @ I _{PP}
V _{RWM}	Working Peak Reverse Voltage
I _R	Maximum Reverse Leakage Current @ V _{RWM}
V _{BR}	Breakdown Voltage @ I _T
I _T	Test Current
ΘV _{BR}	Maximum Temperature Coefficient of V _{BR}

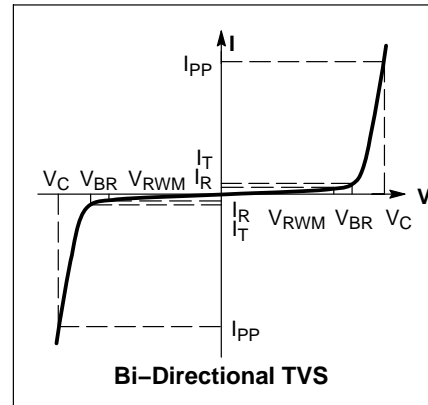

ELECTRICAL CHARACTERISTICS (Devices listed in bold, italic are ON Semiconductor Preferred devices.)

Device*	Device Marking	V _{RWM} (Note 4) Volts	I _R @ V _{RWM} μA	Breakdown Voltage			V _C @ I _{PP} (Note 6)		ΘV _{BR} %/°C	C _{typ} (Note 7) pF	
				V _{BR} Volts (Note 5)			V _C Volts	I _{PP} Amps			
				Min	Nom	Max					@ I _T mA
P6SMB11CAT3, G	11C	9.4	5	10.5	11.05	11.6	1	15.6	38	0.075	865
P6SMB12CAT3, G	12C	10.2	5	11.4	12	12.6	1	16.7	36	0.078	800
P6SMB13CAT3, G	13C	11.1	5	12.4	13.05	13.7	1	18.2	33	0.081	740
P6SMB15CAT3, G	15C	12.8	5	14.3	15.05	15.8	1	21.2	28	0.084	645
P6SMB16CAT3, G	16C	13.6	5	15.2	16	16.8	1	22.5	27	0.086	610
P6SMB18CAT3, G	18C	15.3	5	17.1	18	18.9	1	25.2	24	0.088	545
P6SMB20CAT3, G	20C	17.1	5	19	20	21	1	27.7	22	0.09	490
P6SMB22CAT3, G	22C	18.8	5	20.9	22	23.1	1	30.6	20	0.09	450
P6SMB24CAT3, G	24C	20.5	5	22.8	24	25.2	1	33.2	18	0.094	415
P6SMB27CAT3, G	27C	23.1	5	25.7	27.05	28.4	1	37.5	16	0.096	370
P6SMB30CAT3, G	30C	25.6	5	28.5	30	31.5	1	41.4	14.4	0.097	335
<i>P6SMB33CAT3, G</i>	<i>33C</i>	<i>28.2</i>	<i>5</i>	<i>31.4</i>	<i>33.05</i>	<i>34.7</i>	<i>1</i>	<i>45.7</i>	<i>13.2</i>	<i>0.098</i>	<i>305</i>
P6SMB36CAT3, G	36C	30.8	5	34.2	36	37.8	1	49.9	12	0.099	280
P6SMB39CAT3, G	39C	33.3	5	37.1	39.05	41	1	53.9	11.2	0.1	260
P6SMB43CAT3, G	43C	36.8	5	40.9	43.05	45.2	1	59.3	10.1	0.101	240
P6SMB47CAT3, G	47C	40.2	5	44.7	47.05	49.4	1	64.8	9.3	0.101	220
P6SMB51CAT3, G	51C	43.6	5	48.5	51.05	53.6	1	70.1	8.6	0.102	205
P6SMB56CAT3, G	56C	47.8	5	53.2	56	58.8	1	77	7.8	0.103	185
P6SMB62CAT3, G	62C	53	5	58.9	62	65.1	1	85	7.1	0.104	170
P6SMB68CAT3, G	68C	58.1	5	64.6	68	71.4	1	92	6.5	0.104	155
P6SMB75CAT3, G	75C	64.1	5	71.3	75.05	78.8	1	103	5.8	0.105	140
P6SMB82CAT3, G	82C	70.1	5	77.9	82	86.1	1	113	5.3	0.105	130
P6SMB91CAT3, G	91C	77.8	5	86.5	91	95.5	1	125	4.8	0.106	120

- A transient suppressor is normally selected according to the working peak reverse voltage (V_{RWM}), which should be equal to or greater than the DC or continuous peak operating voltage level.
- V_{BR} measured at pulse test current I_T at an ambient temperature of 25°C.
- Surge current waveform per Figure 2 and derate per Figure 3 of the General Data – 600 Watt at the beginning of this group.
- Bias Voltage = 0 V, F = 1 MHz, T_J = 25°C

*The "G" suffix indicates Pb-Free package available. Please refer back to Ordering Information on front page.

P6SMB11CAT3 Series

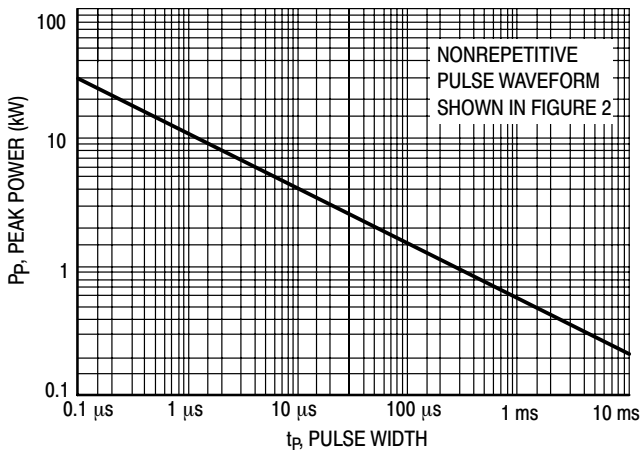

Figure 1. Pulse Rating Curve

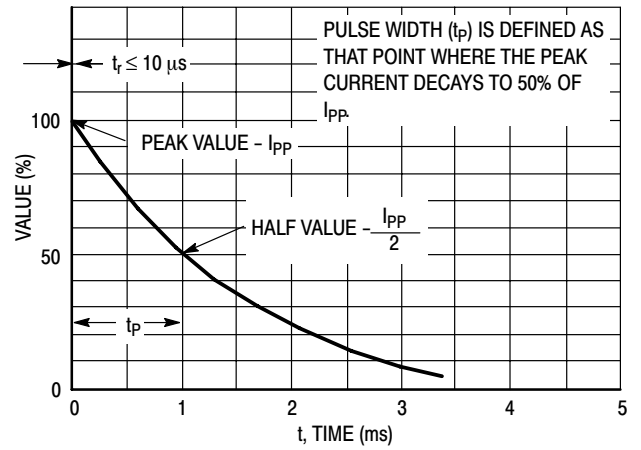

Figure 2. Pulse Waveform

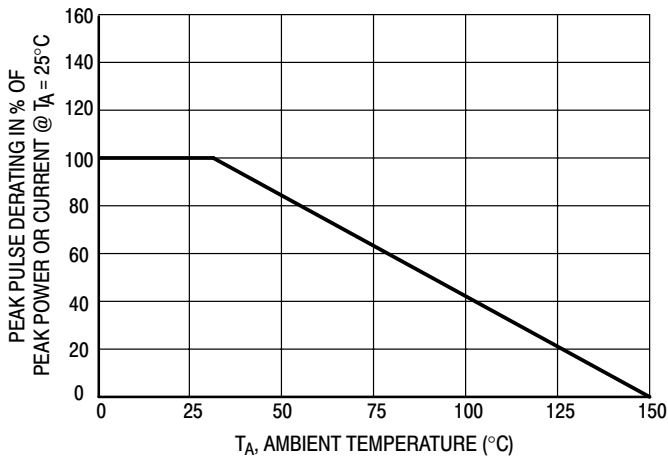

Figure 3. Pulse Derating Curve

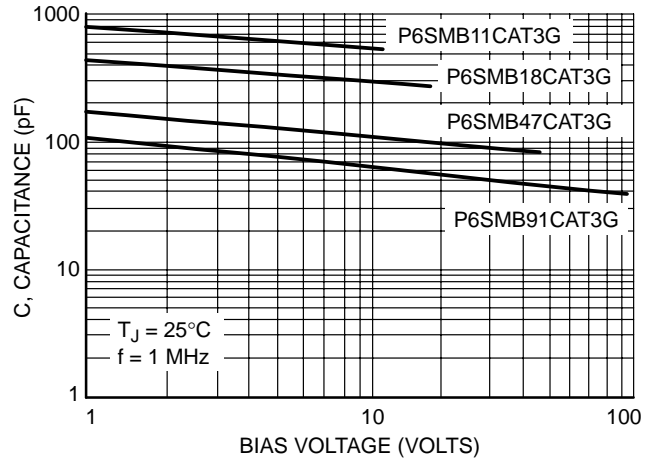
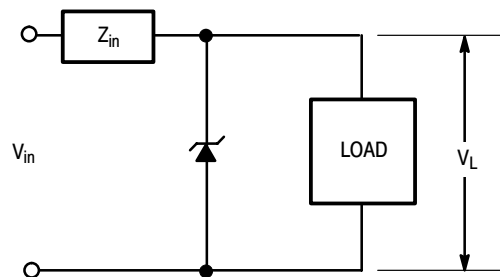

Figure 4. Typical Junction Capacitance vs. Bias Voltage

TYPICAL PROTECTION CIRCUIT



P6SMB11CAT3 Series

APPLICATION NOTES

RESPONSE TIME

In most applications, the transient suppressor device is placed in parallel with the equipment or component to be protected. In this situation, there is a time delay associated with the capacitance of the device and an overshoot condition associated with the inductance of the device and the inductance of the connection method. The capacitive effect is of minor importance in the parallel protection scheme because it only produces a time delay in the transition from the operating voltage to the clamp voltage as shown in Figure 4.

The inductive effects in the device are due to actual turn-on time (time required for the device to go from zero current to full current) and lead inductance. This inductive effect produces an overshoot in the voltage across the equipment or component being protected as shown in Figure 5. Minimizing this overshoot is very important in the application, since the main purpose for adding a transient suppressor is to clamp voltage spikes. The SMB series have a very good response time, typically < 1 ns and negligible inductance. However, external inductive effects could produce unacceptable overshoot. Proper circuit layout, minimum lead lengths and placing the

suppressor device as close as possible to the equipment or components to be protected will minimize this overshoot.

Some input impedance represented by Z_{in} is essential to prevent overstress of the protection device. This impedance should be as high as possible, without restricting the circuit operation.

DUTY CYCLE DERATING

The data of Figure 1 applies for non-repetitive conditions and at a lead temperature of 25°C. If the duty cycle increases, the peak power must be reduced as indicated by the curves of Figure 6. Average power must be derated as the lead or ambient temperature rises above 25°C. The average power derating curve normally given on data sheets may be normalized and used for this purpose.

At first glance the derating curves of Figure 6 appear to be in error as the 10 ms pulse has a higher derating factor than the 10 μ s pulse. However, when the derating factor for a given pulse of Figure 6 is multiplied by the peak power value of Figure 1 for the same pulse, the results follow the expected trend.

P6SMB11CAT3 Series

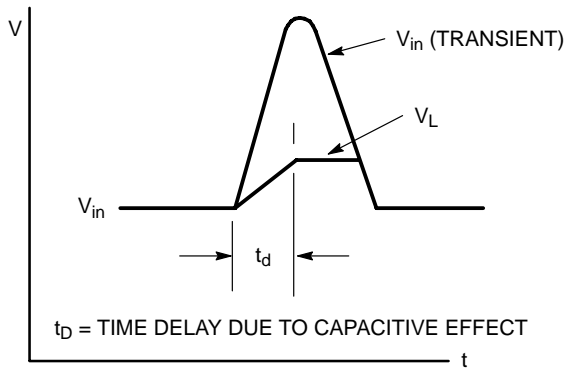

Figure 5.

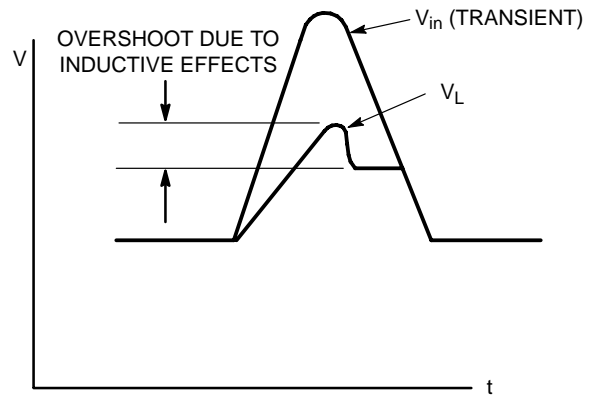

Figure 6.

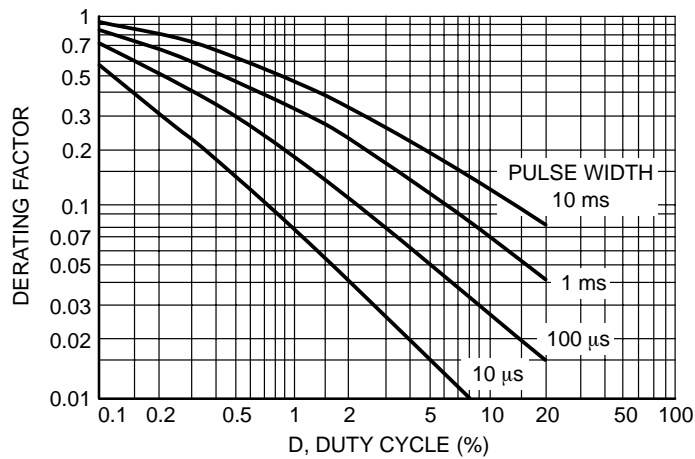

Figure 7. Typical Derating Factor for Duty Cycle

UL RECOGNITION

The entire series has *Underwriters Laboratory Recognition* for the classification of protectors (QVGV2) under the UL standard for safety 497B and File #116110. Many competitors only have one or two devices recognized or have recognition in a non-protective category. Some competitors have no recognition at all. With the UL497B recognition, our parts successfully passed several tests

including Strike Voltage Breakdown test, Endurance Conditioning, Temperature test, Dielectric Voltage-Withstand test, Discharge test and several more.

Whereas, some competitors have only passed a flammability test for the package material, we have been recognized for much more to be included in their Protector category.

P6SMB11CAT3 Series

PACKAGE DIMENSIONS

SMB
DO-214AA
 CASE 403A-03
 ISSUE F

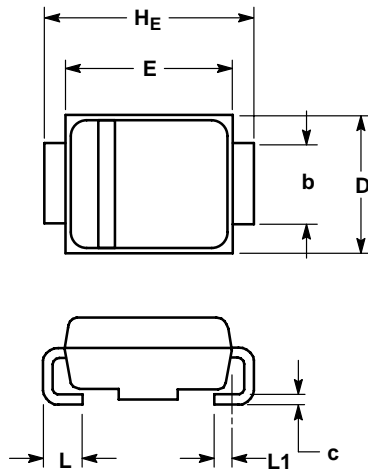

- NOTES:
 1. DIMENSIONING AND TOLERANCING PER ANSI Y14.5M, 1982.
 2. CONTROLLING DIMENSION: INCH.
 3. D DIMENSION SHALL BE MEASURED WITHIN DIMENSION P.

DIM	MILLIMETERS			INCHES		
	MIN	NOM	MAX	MIN	NOM	MAX
A	1.90	2.13	2.45	0.075	0.084	0.096
A1	0.05	0.10	0.20	0.002	0.004	0.008
b	1.96	2.03	2.20	0.077	0.080	0.087
c	0.15	0.23	0.31	0.006	0.009	0.012
D	3.30	3.56	3.95	0.130	0.140	0.156
E	4.06	4.32	4.60	0.160	0.170	0.181
HE	5.21	5.44	5.60	0.205	0.214	0.220
L	0.76	1.02	1.60	0.030	0.040	0.063
L1	0.51 REF			0.020 REF		

SOLDERING FOOTPRINT*

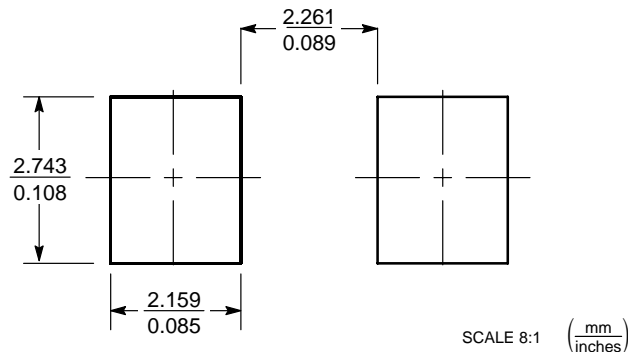

*For additional information on our Pb-Free strategy and soldering details, please download the ON Semiconductor Soldering and Mounting Techniques Reference Manual, SOLDERRM/D.

SURMETIC is a trademark of Semiconductor Components Industries, LLC.

ON Semiconductor and are registered trademarks of Semiconductor Components Industries, LLC (SCILLC). SCILLC reserves the right to make changes without further notice to any products herein. SCILLC makes no warranty, representation or guarantee regarding the suitability of its products for any particular purpose, nor does SCILLC assume any liability arising out of the application or use of any product or circuit, and specifically disclaims any and all liability, including without limitation special, consequential or incidental damages. "Typical" parameters which may be provided in SCILLC data sheets and/or specifications can and do vary in different applications and actual performance may vary over time. All operating parameters, including "Typicals" must be validated for each customer application by customer's technical experts. SCILLC does not convey any license under its patent rights nor the rights of others. SCILLC products are not designed, intended, or authorized for use as components in systems intended for surgical implant into the body, or other applications intended to support or sustain life, or for any other application in which the failure of the SCILLC product could create a situation where personal injury or death may occur. Should Buyer purchase or use SCILLC products for any such unintended or unauthorized application, Buyer shall indemnify and hold SCILLC and its officers, employees, subsidiaries, affiliates, and distributors harmless against all claims, costs, damages, and expenses, and reasonable attorney fees arising out of, directly or indirectly, any claim of personal injury or death associated with such unintended or unauthorized use, even if such claim alleges that SCILLC was negligent regarding the design or manufacture of the part. SCILLC is an Equal Opportunity/Affirmative Action Employer. This literature is subject to all applicable copyright laws and is not for resale in any manner.

PUBLICATION ORDERING INFORMATION

LITERATURE FULFILLMENT:
 Literature Distribution Center for ON Semiconductor
 P.O. Box 5163, Denver, Colorado 80217 USA
Phone: 303-675-2175 or 800-344-3860 Toll Free USA/Canada
Fax: 303-675-2176 or 800-344-3867 Toll Free USA/Canada
Email: orderlit@onsemi.com

N. American Technical Support: 800-282-9855 Toll Free
 USA/Canada
Europe, Middle East and Africa Technical Support:
 Phone: 421 33 790 2910
Japan Customer Focus Center
 Phone: 81-3-5773-3850

ON Semiconductor Website: www.onsemi.com
Order Literature: <http://www.onsemi.com/orderlit>

For additional information, please contact your local Sales Representative