



## 3-Pin, Ultra-Low-Power SC70/SOT23 Voltage Detectors

MAX6375-MAX6380

### General Description

The MAX6375–MAX6380 are ultra-low-power circuits used for monitoring battery, power-supply, and regulated system voltages. Each detector contains a precision bandgap reference, comparator, and internally trimmed resistors that set specified trip threshold voltages. These devices provide excellent circuit reliability and low cost by eliminating external components and adjustments when monitoring nominal system voltages from 2.5V to 5V.

These circuits perform a single function: they assert an output signal whenever the  $V_{CC}$  supply voltage falls below a preset threshold. The devices are differentiated by their output logic configurations and preset threshold voltages. The MAX6375/MAX6378 (push-pull) and MAX6377/MAX6380 (open-drain) have an active-low output ( $\overline{OUT}$  is logic low when  $V_{CC}$  is below  $V_{TH}$ ). The MAX6376/MAX6379 have an active-high push-pull output (OUT is logic high when  $V_{CC}$  is below  $V_{TH}$ ). All parts are guaranteed to be in the correct output logic state for  $V_{CC}$  down to 1V. The detector is designed to ignore fast transients on  $V_{CC}$ . The MAX6375/MAX6376/MAX6377 have voltage thresholds between 2.20V and 3.08V in approximately 100mV increments. The MAX6378/MAX6379/MAX6380 have voltage thresholds between 3.30V and 4.63V in approximately 100mV increments.

Ultra-low supply current of 500nA (MAX6375/MAX6376/MAX6377) makes these parts ideal for use in portable equipment. All six devices are available in a space-saving SC70 package or in a tiny SOT23 package.

### Applications

- Precision Battery Monitoring
- Load Switching/Power Sequencing
- Power-Supply Monitoring in Digital/Analog Systems
- Portable/Battery-Powered Equipment

**Selector Guide appears at end of data sheet.**



**For pricing, delivery, and ordering information, please contact Maxim/Dallas Direct! at 1-888-629-4642, or visit Maxim's website at [www.maxim-ic.com](http://www.maxim-ic.com).**

### Features

- ◆ Ultra-Low 500nA Supply Current (MAX6375/MAX6376/MAX6377)
- ◆ Thresholds Available from 2.20V to 4.63V in Approximately 100mV Increments
- ◆  $\pm 2.5\%$  Threshold Accuracy Over Temperature
- ◆ Low Cost
- ◆ Available in Three Versions: Push-Pull  $\overline{OUT}$ , Push-Pull OUT, and Open-Drain  $\overline{OUT}$
- ◆ Power-Supply Transient Immunity
- ◆ No External Components
- ◆ Available in Either a 3-Pin SC70 or 3-Pin SOT23 Package

### Ordering Information

PART*	TEMP RANGE	PIN-PACKAGE
MAX6375UR __ -T	-40°C to +85°C	3 SOT23-3
MAX6375XR __ -T	-40°C to +85°C	3 SC70-3
MAX6376UR __ -T	-40°C to +85°C	3 SOT23-3
MAX6376XR __ -T	-40°C to +85°C	3 SC70-3

\* The MAX6375/MAX6376/MAX6377 are available in factory-preset thresholds from 2.20V to 3.08V, in approximately 0.1V increments. The MAX6378/MAX6379/MAX6380 are available in factory-preset thresholds from 3.30V to 4.63V, in approximately 0.1V increments. Choose the desired threshold suffix from Table 1 and insert it in the blank spaces following R. There are 21 standard versions, with a required order increment of 2500 pieces. Sample stock is generally held on the standard versions only (see the Selector Guide). The required order increment is 10,000 pieces for nonstandard versions (Table 2). Contact factory for availability. All devices available in tape-and-reel only.

**Ordering information continued at end of data sheet**

### Pin Configuration

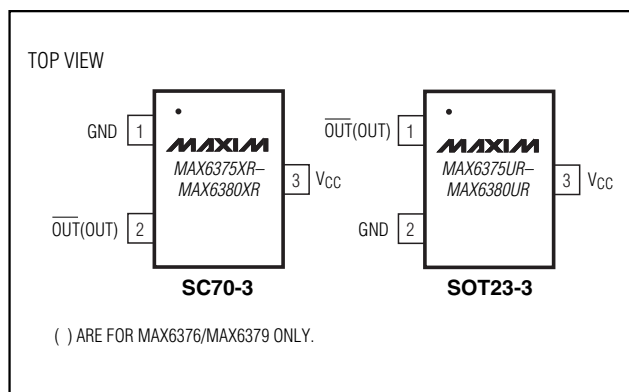

# 3-Pin, Ultra-Low-Power SC70/SOT23 Voltage Detectors

## ABSOLUTE MAXIMUM RATINGS

Terminal Voltage (with respect to GND)

V <sub>CC</sub> .....	-0.3V to +6V
OUT, $\overline{\text{OUT}}$ (push-pull) .....	-0.3V to (V <sub>CC</sub> + 0.3V)
$\overline{\text{OUT}}$ (open-drain) .....	-0.3V to +6V
Input Current (V <sub>CC</sub> ) .....	.20mA
Output Current (OUT, $\overline{\text{OUT}}$ ) .....	.20mA

Continuous Power Dissipation (T<sub>A</sub> = +70°C)

3-Pin SC70 (derate 2.17mW/°C above +70°C) .....	174mW
3-Pin SOT23 (derate 4mW/°C above +70°C) .....	320mW
Operating Temperature Range .....	-40°C to +85°C
Storage Temperature Range .....	-65°C to +150°C
Junction Temperature .....	+150°C
Lead Temperature (soldering, 10s) .....	+300°C

Stresses beyond those listed under "Absolute Maximum Ratings" may cause permanent damage to the device. These are stress ratings only, and functional operation of the device at these or any other conditions beyond those indicated in the operational sections of the specifications is not implied. Exposure to absolute maximum rating conditions for extended periods may affect device reliability.

## ELECTRICAL CHARACTERISTICS

(V<sub>CC</sub> = full range, T<sub>A</sub> = -40°C to +85°C, unless otherwise noted. Typical values are at T<sub>A</sub> = +25°C and V<sub>CC</sub> = 3V.) (Note 1)

PARAMETER	SYMBOL	CONDITIONS	MIN	TYP	MAX	UNITS	
V <sub>CC</sub> Operating Range		T <sub>A</sub> = 0°C to +70°C	1.0		5.5	V	
		T <sub>A</sub> = -40°C to +85°C	1.2		5.5		
Supply Current	I <sub>CC</sub>	MAX6375/76/77 only, V <sub>CC</sub> = 3.0V for V <sub>TH</sub> ≤ 2.93V, V <sub>CC</sub> = 3.2V for V <sub>TH</sub> > 2.93V, no load		0.5	1.0	μA	
		V <sub>CC</sub> = 5.5V, no load		1.0	1.75		
Voltage Threshold	V <sub>TH</sub>	Table 1	T <sub>A</sub> = +25°C	V <sub>TH</sub> - 1.5%	V <sub>TH</sub>	V <sub>TH</sub> + 1.5%	V
			T <sub>A</sub> = -40°C to +85°C	V <sub>TH</sub> - 2.5%	V <sub>TH</sub>	V <sub>TH</sub> + 2.5%	
Voltage Threshold Tempco	ΔV <sub>TH</sub> /°C			40		ppm/°C	
Propagation Delay		V <sub>CC</sub> = (V <sub>TH</sub> + 100mV) to (V <sub>TH</sub> - 100mV)		20		μs	
		V <sub>CC</sub> = (V <sub>TH</sub> - 100mV) to (V <sub>TH</sub> + 100mV)		42			
$\overline{\text{OUT}}$ Output Voltage (MAX6375/MAX6377/MAX6378/MAX6380)	V <sub>OL</sub>	I <sub>SINK</sub> = 1.6mA, V <sub>CC</sub> > 2.1V, $\overline{\text{OUT}}$ asserted			0.3	V	
		I <sub>SINK</sub> = 100μA, V <sub>CC</sub> ≥ 1.2V, $\overline{\text{OUT}}$ asserted			0.4		
$\overline{\text{OUT}}$ Output Voltage (MAX6375/MAX6377)	V <sub>OH</sub>	I <sub>SOURCE</sub> = 500μA, V <sub>CC</sub> = 3.2V, MAX6375 only		0.8 × V <sub>CC</sub>		V	
		I <sub>SOURCE</sub> = 800μA, V <sub>CC</sub> = 4.5V, V <sub>TH</sub> ≤ 4.38V		0.8 × V <sub>CC</sub>			
		I <sub>SOURCE</sub> = 800μA, V <sub>CC</sub> = V <sub>TH</sub> (MAX), V <sub>TH</sub> ≥ 4.5V		0.8 × V <sub>CC</sub>			
OUT Output Voltage (MAX6376/MAX6379)	V <sub>OH</sub>	I <sub>SOURCE</sub> = 500μA, V <sub>CC</sub> ≥ 2.1V, OUT asserted		0.8 × V <sub>CC</sub>		V	
		I <sub>SOURCE</sub> = 50μA, V <sub>CC</sub> ≥ 1.2V, OUT asserted		0.8 × V <sub>CC</sub>			
	V <sub>OL</sub>	I <sub>SINK</sub> = 1.2mA, V <sub>CC</sub> ≥ 3.2V, OUT not asserted, MAX6376 only			0.3		
		I <sub>SINK</sub> = 3.2mA, V <sub>CC</sub> ≥ 4.5V, OUT not asserted, V <sub>TH</sub> ≤ 4.38V			0.4		
		I <sub>SINK</sub> = 3.2mA, V <sub>CC</sub> = V <sub>TH</sub> (MAX), V <sub>TH</sub> ≥ 4.5V			0.4		
Voltage Threshold Hysteresis		MAX6375/MAX6376/MAX6377		6.3		mV	
		MAX6378/MAX6379/MAX6380		9.5			
Open-Drain $\overline{\text{OUT}}$ Output Leakage Current					0.1	μA	

**Note 1:** Production tested at +25°C only. Overtemperature limits are guaranteed by design, not production tested.

# 3-Pin, Ultra-Low-Power SC70/SOT23 Voltage Detectors

## Typical Operating Characteristics

( $V_{CC} = 5V$ ,  $T_A = +25^\circ C$ , unless otherwise noted.)

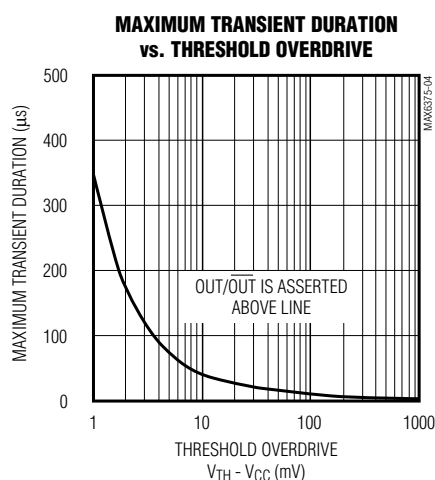
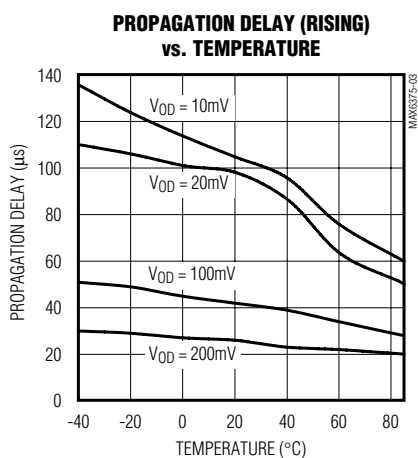
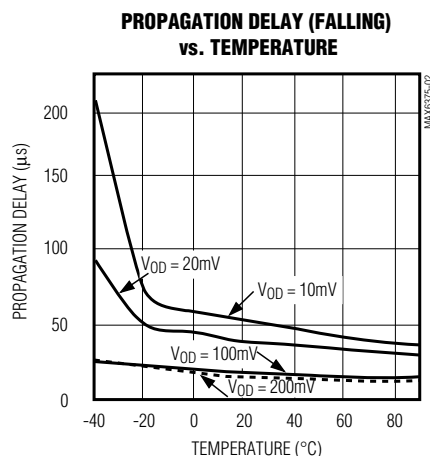
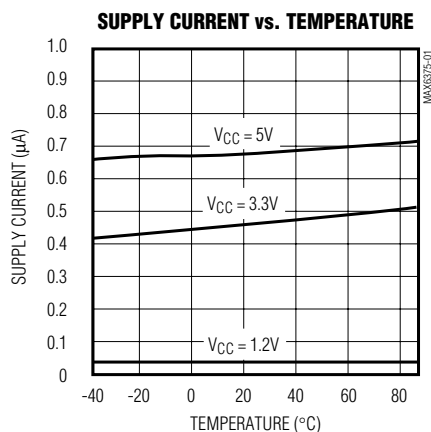

## Pin Description

PIN				NAME	FUNCTION
MAX6375/MAX6377/ MAX6378/MAX6380		MAX6376/MAX6379			
SC70-3	SOT23-3	SC70-3	SOT23-3		
1	2	1	2	GND	Ground
2	1	—	—	$\overline{OUT}$	Active-Low Output. $\overline{OUT}$ remains low while $V_{CC}$ is below the threshold. $\overline{OUT}$ is open-drain on the MAX6377/MAX6380 and push-pull on the MAX6375/MAX6378.
—	—	2	1	OUT	Active-High Output. OUT remains high while $V_{CC}$ is below the threshold.
3	3	3	3	$V_{CC}$	Supply Voltage

# 3-Pin, Ultra-Low-Power SC70/SOT23 Voltage Detectors

## Applications Information

### Interfacing to Different Logic Voltage Components

The MAX6377/MAX6380 have an active-low, open-drain output. This output structure sinks current when  $\overline{\text{OUT}}$  is asserted. Connect a pullup resistor from  $\overline{\text{OUT}}$  to any supply voltage up to 5.50V (Figure 1). Select a resistor value large enough to allow a valid logic low (see *Electrical Characteristics*), and small enough to register a logic high while supplying all input current and leakage paths connected to the  $\overline{\text{OUT}}$  line.

### Negative-Going Vcc Transients

These devices are relatively immune to short-duration, negative-going Vcc transients (glitches). The *Typical Operating Characteristics* show the Maximum Transient Duration vs. Threshold Overdrive graph, for which output pulses are not generated. The graph shows the maximum pulse width that a negative-going Vcc transient may typically have before the devices issue output signals. As the amplitude of the transient increases, the maximum-allowable pulse width decreases.

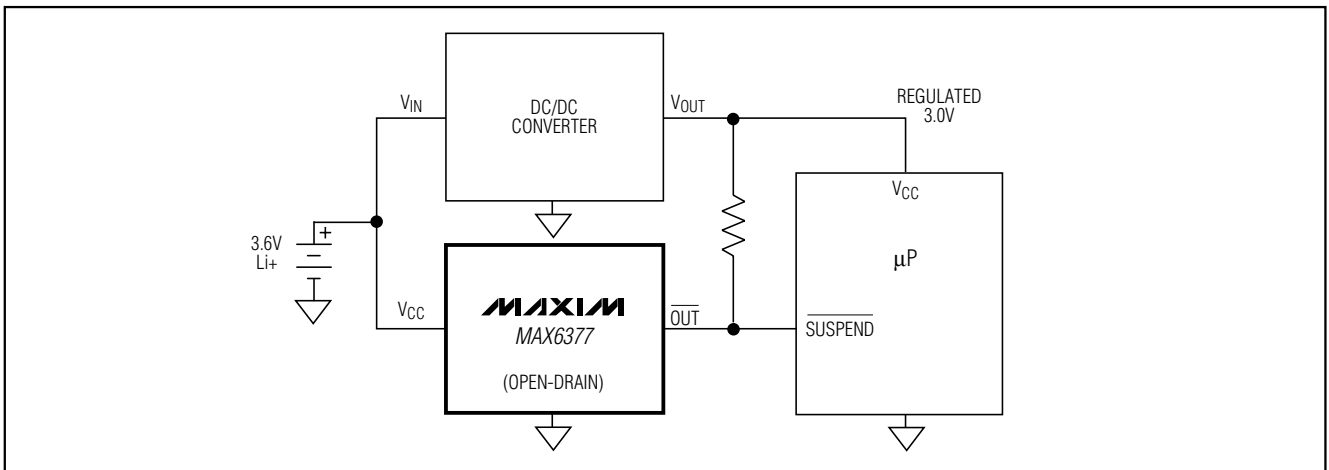

Figure 1. Interfacing to Different Logic Voltage Components

Table 1. Factory-Trimmed Reset Thresholds‡

PART	SUFFIX	RESET THRESHOLD VOLTAGE, V <sub>TH</sub> (V)				
		T <sub>A</sub> = +25°C			T <sub>A</sub> = -40°C TO +85°C	
		MIN	TYP	MAX	MIN	MAX
MAX6375_R	22	2.167	2.200	2.233	2.145	2.250
	23	2.285	2.320	2.355	2.262	2.375
	24	2.364	2.400	2.436	2.340	2.460
	25	2.462	2.500	2.537	2.437	2.562
MAX6376_R	26	2.591	2.630	2.669	2.564	2.696
	27	2.660	2.700	2.741	2.633	2.768
MAX6377_R	28	2.758	2.800	2.842	2.730	2.870
	29	2.886	2.930	2.974	2.857	3.000
	30	2.955	3.000	3.045	2.925	3.075
	31	3.034	3.080	3.126	3.003	3.150

‡Factory-trimmed reset thresholds are available in approximately 100mV increments with a 1.5% room-temperature variance.

# 3-Pin, Ultra-Low-Power SC70/SOT23 Voltage Detectors

**MAX6375-MAX6380**

**Table 1. Factory-Trimmed Reset Thresholds<sup>‡</sup> (continued)**

PART	SUFFIX	RESET THRESHOLD VOLTAGE, V <sub>TH</sub> (V)				
		T <sub>A</sub> = +25°C			T <sub>A</sub> = -40°C TO +85°C	
		MIN	TYP	MAX	MIN	MAX
MAX6378_R	33	3.250	3.300	3.350	3.217	3.383
	34	3.349	3.400	3.451	3.315	3.485
	35	3.447	3.500	3.552	3.412	3.587
	36	3.546	3.600	3.654	3.510	3.690
	37	3.644	3.700	3.755	3.607	3.792
MAX6379_R	38	3.743	3.800	3.857	3.705	3.895
	39	3.841	3.900	3.958	3.802	3.997
MAX6380_R	40	3.940	4.000	4.060	3.900	4.100
	41	4.038	4.100	4.161	3.997	4.202
	42	4.137	4.200	4.263	4.095	4.305
	43	4.235	4.300	4.364	4.192	4.407
	44	4.314	4.380	4.446	4.270	4.489
	45	4.432	4.500	4.567	4.387	4.612
	46	4.560	4.630	4.699	4.514	4.746

<sup>‡</sup>Factory-trimmed reset thresholds are available in approximately 100mV increments with a 1.5% room-temperature variance.

**Table 2. Device Marking Codes and Minimum Order Increments**

PART	TOP MARK (SC70)	TOP MARK (SOT23)	ORDER INCREMENT (k)
MAX6375_R22-T	ADH	FZHD	2.5
MAX6375_R23-T	ADI	FZHE	2.5
MAX6375_R24-T	—	—	10
MAX6375_R25-T	—	—	10
MAX6375_R26-T	ACZ	FZHC	2.5
MAX6375_R27-T	—	—	10
MAX6375_R28-T	—	—	10
MAX6375_R29-T	ADJ	FZHF	2.5
MAX6375_R30-T	—	—	10
MAX6375_R31-T	ADK	FZHG	2.5
MAX6376_R22-T	ADL	FZHH	2.5
MAX6376_R23-T	ADM	FZHI	2.5
MAX6376_R24-T	—	—	10
MAX6376_R25-T	—	—	10
MAX6376_R26-T	ADN	FZHJ	2.5
MAX6376_R27-T	—	—	10
MAX6376_R28-T	—	—	10
MAX6376_R29-T	ADA	FZHK	2.5
MAX6376_R30-T	—	—	10
MAX6376_R31-T	ADO	FZHL	2.5
MAX6377_R22-T	ADP	FZHM	2.5
MAX6377_R23-T	ADB	FZHN	2.5
MAX6377_R24-T	—	—	10
MAX6377_R25-T	—	—	10
MAX6377_R26-T	ACQ	FZHO	2.5
MAX6377_R27-T	—	—	10
MAX6377_R28-T	—	—	10
MAX6377_R29-T	ADC	FZHP	2.5
MAX6377_R30-T	—	—	10
MAX6377_R31-T	ADR	FZHQ	2.5
MAX6378_R33-T	—	—	10
MAX6378_R34-T	—	—	10
MAX6378_R35-T	—	—	10
MAX6378_R36-T	—	—	10
MAX6378_R37-T	—	—	10
MAX6378_R38-T	—	—	10

## 3-Pin, Ultra-Low-Power SC70/SOT23 Voltage Detectors

Table 2. Device Marking Codes and Minimum Order Increments (continued)

PART	TOP MARK (SC70)	TOP MARK (SOT23)	ORDER INCREMENT (k)
MAX6378_R39-T	—	—	10
MAX6378_R40-T	—	—	10
MAX6378_R41-T	—	—	10
MAX6378_R42-T	—	—	10
MAX6378_R43-T	—	—	10
MAX6378_R44-T	ADS	FZHU	2.5
MAX6378_R45-T	—	—	10
MAX6378_R46-T	ADD	FZHV	2.5
<b>MAX6379</b> _R33-T	—	—	10
MAX6379_R34-T	—	—	10
MAX6379_R35-T	—	—	10
MAX6379_R36-T	—	—	10
MAX6379_R37-T	—	—	10
MAX6379_R38-T	—	—	10
MAX6379_R39-T	—	—	10
MAX6379_R40-T	—	—	10
MAX6379_R41-T	—	—	10
MAX6379_R42-T	—	—	10

PART	TOP MARK (SC70)	TOP MARK (SOT23)	ORDER INCREMENT (k)
MAX6379_R43-T	—	—	10
MAX6379_R44-T	ADE	FZHW	2.5
MAX6379_R45-T	—	—	10
MAX6379_R46-T	ADT	FZHX	2.5
<b>MAX6380</b> _R33-T	—	—	10
MAX6380_R34-T	—	—	10
MAX6380_R35-T	—	—	10
MAX6380_R36-T	—	—	10
MAX6380_R37-T	—	—	10
MAX6380_R38-T	—	—	10
MAX6380_R39-T	—	—	10
MAX6380_R40-T	—	—	10
MAX6380_R41-T	—	—	10
MAX6380_R42-T	—	—	10
MAX6380_R43-T	—	—	10
MAX6380_R44-T	ADU	FZHY	2.5
MAX6380_R45-T	—	—	10
MAX6380_R46-T	ADF	FZHZ	2.5

### Chip Information

TRANSISTOR COUNT: 419

### Selector Guide (Standard Versions\*\*)

PART	NOMINAL V <sub>TH</sub> (V)
MAX63 ___ R46-T	4.63
MAX63 ___ R44-T	4.38
MAX63 ___ R31-T	3.08
MAX63 ___ R29-T	2.93
MAX63 ___ R26-T	2.63
MAX63 ___ R23-T	2.32
MAX63 ___ R22-T	2.20

\*\*Sample stock is generally held on all standard versions. Contact factory for availability of nonstandard versions.

### Ordering Information (continued)

PART*	TEMP RANGE	PIN-PACKAGE
<b>MAX6377</b> UR __ -T	-40°C to +85°C	3 SOT23-3
MAX6377XR __ -T	-40°C to +85°C	3 SC70-3
<b>MAX6378</b> UR __ -T	-40°C to +85°C	3 SOT23-3
MAX6378XR __ -T	-40°C to +85°C	3 SC70-3
<b>MAX6379</b> UR __ -T	-40°C to +85°C	3 SOT23-3
MAX6379XR __ -T	-40°C to +85°C	3 SC70-3
<b>MAX6380</b> UR __ -T	-40°C to +85°C	3 SOT23-3
MAX6380XR __ -T	-40°C to +85°C	3 SC70-3

\*The MAX6375/MAX6376/MAX6377 are available in factory-preset thresholds from 2.20V to 3.08V, in approximately 0.1V increments. The MAX6378/MAX6379/MAX6380 are available in factory-preset thresholds from 3.30V to 4.63V, in approximately 0.1V increments. Choose the desired threshold suffix from Table 1 and insert it in the blank spaces following R. There are 21 standard versions, with a required order increment of 2500 pieces. Sample stock is generally held on the standard versions only (see the Selector Guide). The required order increment is 10,000 pieces for nonstandard versions (Table 2). Contact factory for availability. All devices available in tape-and-reel only.

# 3-Pin, Ultra-Low-Power SC70/SOT23 Voltage Detectors

## Package Information

(The package drawing(s) in this data sheet may not reflect the most current specifications. For the latest package outline information, go to [www.maxim-ic.com/packages](http://www.maxim-ic.com/packages).)

**NOTES:**

1. D&E DO NOT INCLUDE MOLD FLASH.
2. MOLD FLASH OR PROTRUSIONS NOT TO EXCEED .15mm (.006").
3. CONTROLLING DIMENSION: MILLIMETERS.
4. REFERENCE JEDEC TO236.
5. LEADS TO BE COPLANAR WITHIN 0.10mm.

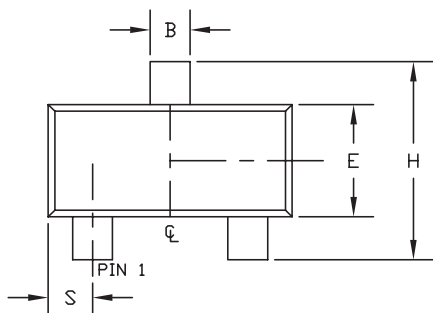

DIM	INCHES		MILLIMETERS	
	MIN	MAX	MIN	MAX
A	0.035	0.044	0.890	1.120
A1	0.001	0.004	0.013	0.100
B	0.015	0.020	0.370	0.510
C	0.003	0.071	0.085	0.180
D	0.110	0.120	2.800	3.040
E	0.047	0.055	1.200	1.400
e	0.070	0.081	1.780	2.050
H	0.083	0.104	2.100	2.640
L	0.008	0.017	0.210	0.420
L1	0.021	REF	0.54	REF
S	0.018	0.024	0.45	0.60
$\alpha$	0°	8°	0°	8°

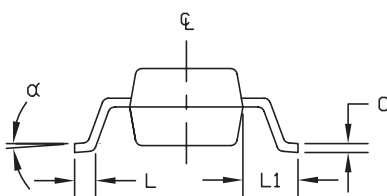
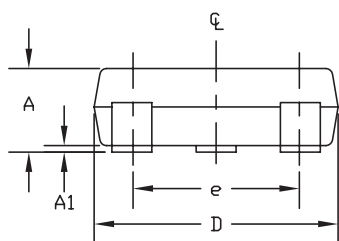

<small>PROPRIETARY INFORMATION</small>	
<small>TITLE:</small> PACKAGE OUTLINE, 3L SOT-23	
<small>APPROVAL</small>	<small>DOCUMENT CONTROL NO.</small> 21-0051
<small>REV.</small> E	<small>1/1</small>

SOT23 L-EPS

**MAX6375-MAX6380**

Maxim cannot assume responsibility for use of any circuitry other than circuitry entirely embodied in a Maxim product. No circuit patent licenses are implied. Maxim reserves the right to change the circuitry and specifications without notice at any time.

**Maxim Integrated Products, 120 San Gabriel Drive, Sunnyvale, CA 94086 408-737-7600** 7