

REVISIONS FOR DWG # 3EN-3IS-AL-AL2616-9

REV	CH.NO.	DESCRIPTION	DATE	REVISED BY
-	-	ORIGINAL DESIGN	08/01/11	ROLAND G

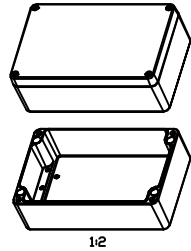

SECTION A-A

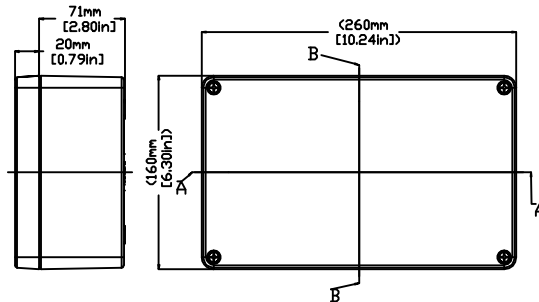
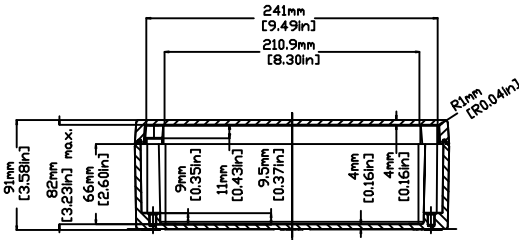

SECTION C-C

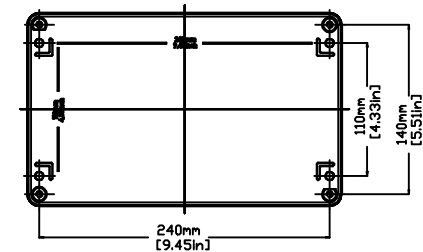
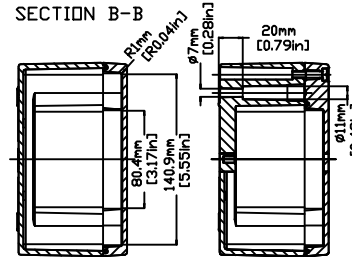

BOTTOM VIEW

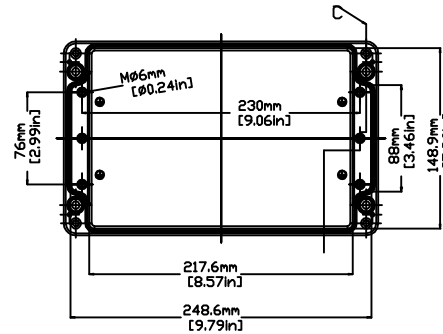

INTERIOR VIEW WITHOUT LID

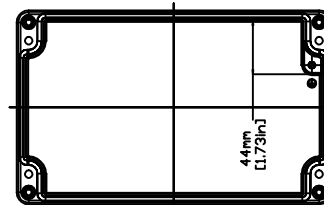

INTERIOR VIEW OF LID

UNLESS OTHERWISE SPECIFIED  
 • ALL DIMENSIONS ARE IN MILLIMETERS  
 • THIRD ANGLE PROJECTION

TOLERANCE	Symbol	XX mm
XX.X	±	XX mm
XX.XX	±	XX mm
ALL	±	XX mm

FIRST ANGLE

This Drawing is the property of

**Altrech Corp.**

35 Royal Road  
 Flemington NJ 08822-6000  
 (908) 806-9400 • Fax (908) 806-9490

AND IS A CONFIDENTIAL DISCLOSURE  
 LENT WITHOUT CONSIDERATION OTHER  
 THAN THE BORROWER'S AGREEMENT  
 THAT IT SHALL NOT BE REPRODUCED,  
 COPIED, LENT, OR DISPOSED OF  
 DIRECTLY OR INDIRECTLY NOR USED  
 FOR ANY PURPOSE OTHER THAN THAT  
 FOR WHICH IT IS SPECIFICALLY  
 FURNISHED.

TITLE: ALUMINUM ENCLOSURE  
 AL 2616-9 (150-012)

DRAWN BY: ROLAND GYORGYAL	08/01/2011	DRAWING NO.:	3EN-3IS-AL-AL2616_9	REV.:	-
CHECKED BY: JEFF ROYE	08/01/2011	SCALE:	-	SHEET:	1 OF: 1
RELEASED BY: LASZLO G.	08/01/2011				