

Various Accessories Expand the Usefulness of the Fiber-Optic Cables

- Lenses extend sensing distances
- Side-view attachments provide space savings
- Flexible stainless steel tubes protect plastic fibers from mechanical damage
- Thin fiber adapters as replacement
- Splices for 2.2 mm fiber can be used to repair cut fiber
- Pinpoint focusing lens for precise positioning

Ordering Information

■ ATTACHMENTS

Description	Part number
Focusing lens pair (use with E32-TC50/200/500/1000, E32-T11(L), E32-TC200C, E32-T61)	E39-F1
Side-view reflector pair	E39-F2
Convergent beam conversion kit (to fit fibers that accept E39-F1 lenses)	E39-F3
Pinpoint focusing lens (for E32-D32, E32-C42, E32-C31, E32-C41)	E39-F3A, -F3A-5, -F3B, -F3C
Side-view diffuse reflective conversion kit (for through-beam fibers)	E39-F5

■ PROTECTIVE STAINLESS STEEL FLEXIBLE TUBES FOR PLASTIC FIBERS

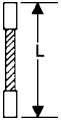
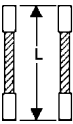
Description	Appearance	Length (L)	Part number
E32-DC200E, E32-DC200F(4), E32-D21, E32-D21L	 Single tubes	0.5 m	E39-F32A5
		1 m	E39-F32A
E32-DC200, E32-DC200B(4), E32-CC200, E32-D11 E32-D11L, E32-D51		0.5 m	E39-F32D5
		1 m	E39-F32D
E32-TC200E, E32-TC200F(4), E32-T21, E32-T12L	 Pairs	0.5 m	E39-F32B5
		1 m	E39-F32B
E32-TC200, E32-TC200B(4), E32-T11, E32-T11L, E32-T51L		0.5 m	E39-F32C5
		1 m	E39-F32C

■ ADAPTERS/REPAIR PARTS

Description	Part number
Thin fiber adapter (1.0 mm to 2.2 mm dia.)	E39-F9
Splice for 2.2 mm dia. fiber (except E32-T51/E32-D51)	E39-F10
Fiber cutting tool (supplied with each trimmable plastic fiber optic cable)	E39-F4
Fiber probe bending tool	E39-F11
Mounting bracket replacement for E32-T16 (order two)	E39-L4

Dimensions

Unit: mm (inch)

ATTACHMENTS

E39-F1

Lens kit (pair)

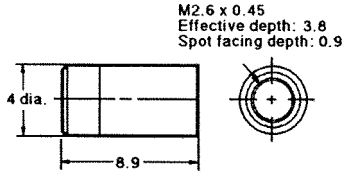

Note: One set includes two units.

E39-F2

Side-view attachment (pair)

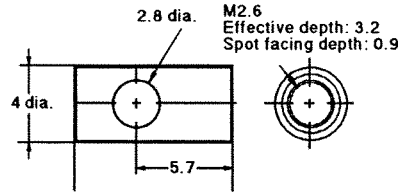

Note: One set includes two units.

E39-F3

Convergent beam conversion kit

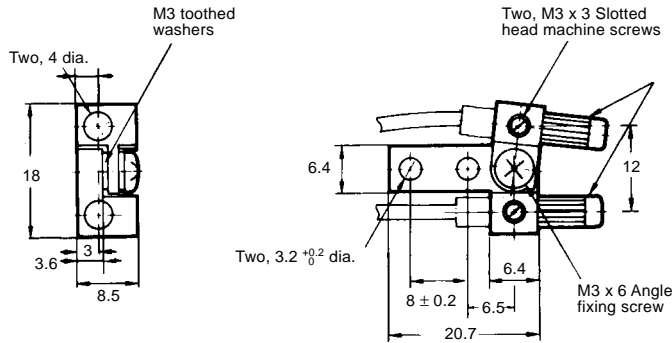

E39-F5

Side-view diffuse reflective conversion kit

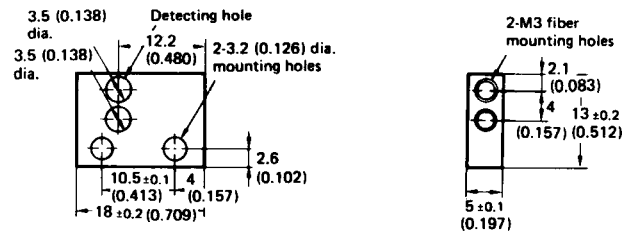

E39-F3A

Small Spot Lens Unit

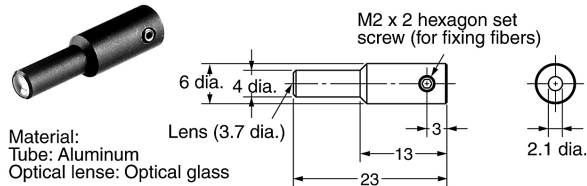

Note: E39-F3A is a Lens Unit for the E32-D32 and E32-C42.

E39-F3A-5

Small Spot Lens Unit

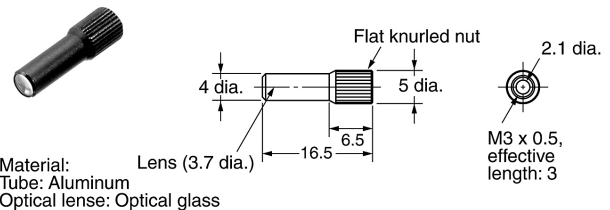

Note: E39-F3A-5 is a Lens Unit for the E32-C31 and E32-C41.

E39-F3B

Small Spot Lens Unit

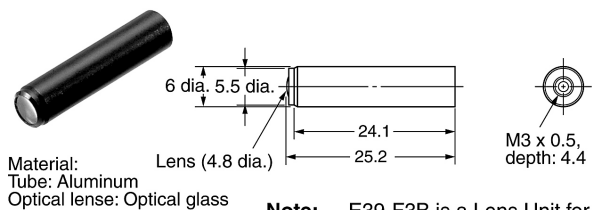

Note: E39-F3B is a Lens Unit for the E32-C31 and E32-C41.

E39-F3C

Small Spot Lens Unit

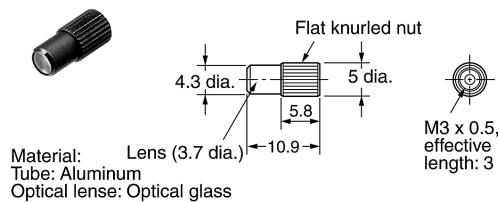

Note: E39-F3C is a Lens Unit for the E32-C31 and E32-C41.

Unit: mm (inch)

■ PROTECTIVE STAINLESS STEEL TUBES

E39-F32A, E39-F32A5
E39-F32B, E39-F32B5

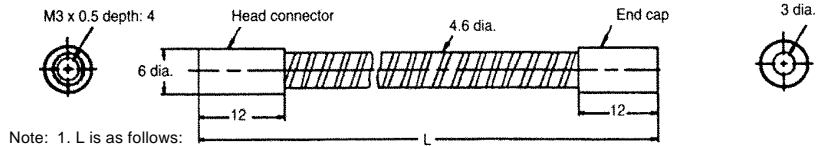
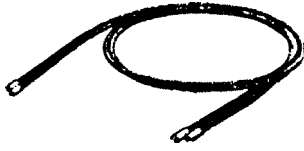

Note: 1. L is as follows:
E39-F32A and E39-F32B: 1,000
E39-F32A5, E39-F32B5: 500

2. These are sold as pairs.

E39-F32C, E39-F32C5

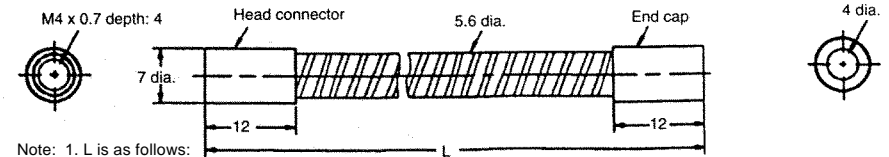
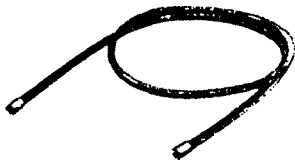

Note: 1. L is as follows:
E39-F32C: 1,000
E39-F32C5: 500

2. These are sold as single pairs.

E39-F32D, E39-F32D5

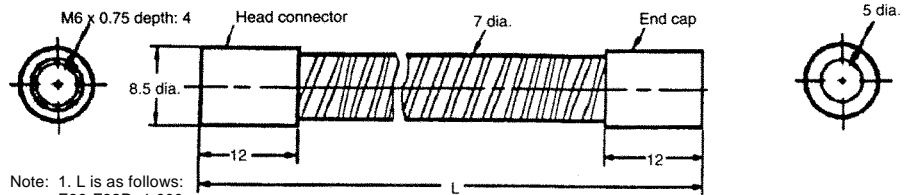

Note: 1. L is as follows:
E39-F32D: 1,000
E39-F32D5: 500

2. These are sold as single tubes.

■ ADAPTERS/REPAIR PARTS

E39-F4
Fiber cutter

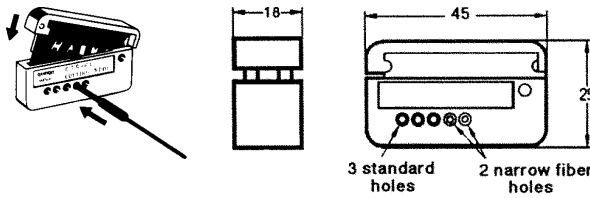

E39-F11
Bending tool

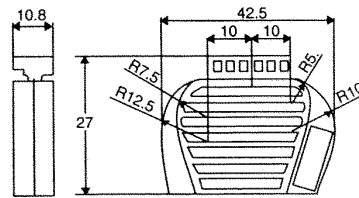

E39-F9
Attachment for thin fiber

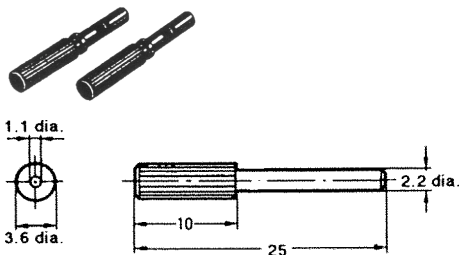

E39-F10
Fiber connector

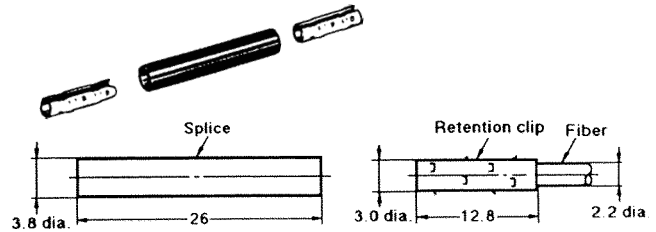

Installation

■ INSTALLING ACCESSORIES

E39-F1 Lens Kit

This pair of lenses increases the sensing distance of selected fiber-optic cables. To install, screw each lens onto the threaded tip of each sensing head.

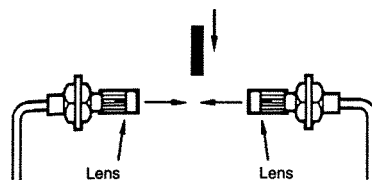

Amplifier	Sensing distance with fiber-optic cables									
Part number	Fiber-optic cable	E32-T11	E32-T11L	E32-T11R	E32-TC50	E32-TC200	E32-TC200C	E32-TC500	E32-TC1000	E32-T61
E3X-A	w/ lens	1 m (3.3 ft)	1 m (3.3 ft)	1 m (3.3 ft)	1.5 m (4.9 ft)	1.5 m (4.9 ft)	800 mm (31.5 in)	1.5 m (4.9 ft)	1 m (3.3 ft)	1.5 m (4.9 ft)
	w/o lens	180 mm (7.1 in)	350 mm (13.8 in)	140 mm (5.5 in)	200 mm (7.9 in)	200 mm (7.9 in)	150 mm (5.9 in)	200 mm (7.9 in)	500 mm (19.7 in)	150 mm (5.9 in)
E3X-DA-N	w/ lens	4 m (13.1 ft)	4 m (13.1 ft)	4 m (13.1 ft)	Contact Omron	4 m (13.1 ft)	Contact Omron	Contact Omron	Contact Omron	4 m (13.1 ft)
	w/o lens	850 mm (33.5 in)	1.66 m (5.5 ft)	670 mm (26.4 in)	Contact Omron	950 mm (37.4 in)	Contact Omron	Contact Omron	Contact Omron	570 mm (22.4 in)
E3X-F	w/ lens	400 mm (15.8 in)	550 mm (21.7 in)	Contact Omron	—	670 mm (26.4 in)	350 mm (13.8 in)	—	1 m (3.3 ft)	450 mm (17.7 in)
	w/o lens	80 mm (3.2 in)	150 mm (5.9 in)	Contact Omron	—	80 mm (3.1 in)	60 mm (2.4 in)	—	500 mm (19.7 in)	60 mm (2.4 in)
E3X-H	w/ lens	2 m (6.6 ft)	2 m (6.6 ft)	2.1 m (6.9 ft)	3 m (9.8 ft)	3 m (9.8 ft)	1.6 m (5.2 ft)	3 m (9.8 ft)	1 m (3.3 ft)	3 m (9.8 ft)
	w/o lens	360 mm (14.2 in)	700 mm (27.6 in)	280 mm (11.0 in)	400 mm (15.7 in)	400 mm (15.7 in)	300 mm (11.8 in)	400 mm (15.7 in)	500 mm (19.7 in)	300 mm (11.8 in)
E3X-NH	w/ lens	2 m (6.6 ft)	2 m (6.6 ft)	2.1 m (6.9 ft)	Contact Omron	3 m (9.8 ft)	3.6 m (11.8 ft)	Contact Omron	Contact Omron	3 m (9.8 ft)
	w/o lens	360 mm (14.2 in)	700 mm (27.6 in)	280 mm (11.0 in)	Contact Omron	400 mm (15.7 in)	300 mm (11.8 in)	Contact Omron	Contact Omron	300 mm (11.8 in)
E3X-NHB	w/ lens	250 mm (9.8 in)	250 mm (9.8 in)	Contact Omron	Contact Omron	420 mm (16.5 in)	Contact Omron	Contact Omron	Contact Omron	Contact Omron
	w/o lens	90 mm (3.5 in)	90 mm (3.5 in)	Contact Omron	Contact Omron	55 mm (2.2 in)	Contact Omron	Contact Omron	Contact Omron	Contact Omron
E3X-NM	w/ lens	1.3 m (4.3 ft)	1.2 m (3.9 ft)	1.3 m (4.3 ft)	Contact Omron	2 m (6.6 ft)	800 mm (31.5 in)	Contact Omron	Contact Omron	2 m (6.6 ft)
	w/o lens	240 mm (9.4 in)	500 mm (19.7 in)	180 mm (7.1 in)	Contact Omron	270 mm (10.6 in)	200 mm (7.9 in)	Contact Omron	Contact Omron	180 mm (7.1 in)
E3X-NT	w/ lens	1.4 m (4.6 ft)	1.28 m (4.2 ft)	1.4 m (4.6 ft)	Contact Omron	2.1 m (6.9 ft)	850 mm (33.5 in)	Contact Omron	Contact Omron	2.1 m (6.9 ft)
	w/o lens	260 mm (10.2 in)	540 mm (21.3 in)	200 mm (7.9 in)	Contact Omron	290 mm (11.4 in)	210 mm (8.3 in)	Contact Omron	Contact Omron	190 mm (7.5 in)
E3X-NV	w/ lens	1.4 m (4.6 ft)	1.28 m (4.2 ft)	1.4 m (4.6 ft)	Contact Omron	2.1 m (6.9 ft)	850 mm (33.5 in)	Contact Omron	Contact Omron	2.1 m (6.9 ft)
	w/o lens	260 mm (10.2 in)	540 mm (21.3 in)	200 mm (7.9 in)	Contact Omron	290 mm (11.4 in)	210 mm (8.3 in)	Contact Omron	Contact Omron	190 mm (7.5 in)
E3X-NVG	w/ lens	120 mm (4.7 in)	120 mm (4.7 in)	Contact Omron	Contact Omron	190 mm (7.5 in)	100 mm (3.9 in)	Contact Omron	Contact Omron	130 mm (5.1 in)
	w/o lens	10 mm (0.4 in)	40 mm (1.6 in)	Contact Omron	Contact Omron	28 mm (1.1 in)	18 mm (0.7 in)	Contact Omron	Contact Omron	18 mm (0.7 in)
E3X-VG	w/ lens	120 mm (4.7 in)	120 mm (4.7 in)	Contact Omron	190 mm (7.5 in)	190 mm (7.5 in)	100 mm (3.9 in)	—	1 m (3.3 ft)	130 mm (5.1 in)
	w/o lens	10 mm (0.4 in)	40 mm (1.6 in)	Contact Omron	28 mm (1.1 in)	28 mm (1.1 in)	18 mm (0.7 in)	—	500 mm (19.7 in)	18 mm (0.7 in)

E39-F2 Side View Attachment

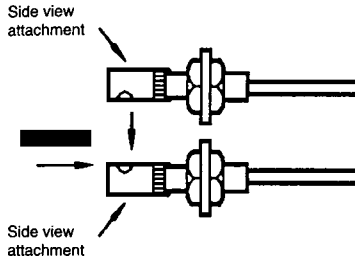

These attachments provide 90° angle viewing for through-beam cables. Use them with E32-TC50, E32-TC200 and E32-TC200C plastic filament cables and E32-T61 glass filament cables. Screw each piece onto the threaded tip of each sensing head.

Note: This attachment does not increase sensing distance.

E39-F3 Diffuse Reflective Conversion Bracket

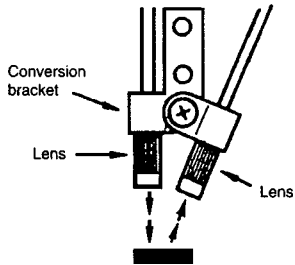

This bracket converts through-beam fiber cables for diffuse reflective sensing. Use it with E32-TC50, E32-TC200 and E32-TC200C plastic filament cables. A set of E39-F1 lenses are supplied with this conversion bracket. To install, first remove the mounting nuts from the fiber-optic sensing heads. Then loosen the two set screws on the bracket. Insert the sensing

ends through the bracket, then attach the lenses. Tighten the two set screws to hold the sensing heads in place. Mount the bracket at the detection site, then loosen the large center screw to adjust the angle. When the angle that produces reliable detection has been found, tighten the screw to retain that angle.

E39-F3A Reflective Unit Lens (for E32-D32 Fiber)

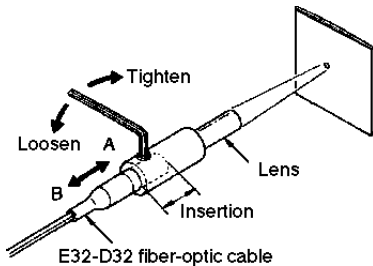

When E39-F3A is attached to an E32-D32 fiber, adjust the focal point so that the amplifier will not detect its own light reflected from inside the E39-F3A.

Place the object to be detected or while paper at the sensing distance, then adjust the insertion depth of the fiber into the

E39-F3A so that the light spot is as small as possible. Then fasten the sensing head using the Allen head wrench supplied with the E39-F3A.

In the example shown,
A = The focus is farther than the E39-F3A
B = The focus is closer than the E39-F3A.

E39-F5 Diffuse Reflective Side View Conversion Block

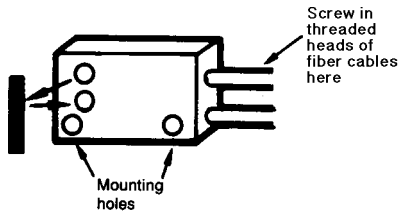

This reflective side view block may be used with E32-TC200A plastic filament fiber-optic cable only. It provides a 2 cm (0.79 in) sensing distance. To install, first remove mounting nuts and washers from fiber-optic sensing head. Then, screw the threaded heads as far as they will go onto the mounting holes on the narrow side of the block.

Protective Stainless Steel Tubes

Insert the fiber into the protective armor tube from the head connector side (threaded) of the tube.

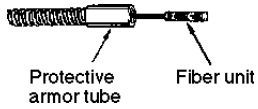

Push the fiber into the armor tube. The tube should be straight so that the fiber is not twisted when inserted. Then turn the end cap of the tube.

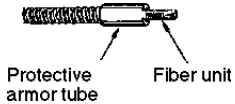

Secure the tube on a suitable place with the attached nut.

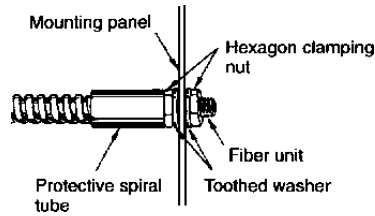

Use the attached saddle to secure the end cap of the tube. To secure the tube at a

position other than at the end cap, apply tape to the tube so that the portion becomes thicker in diameter

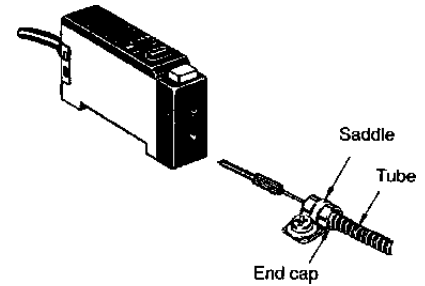

Chemical Resistance

Do NOT use a fiber-optic cable and amplifier in an atmosphere containing organic solvents such as paint thinner vapors.

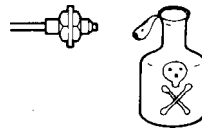

OMRON

OMRON ELECTRONICS LLC

One East Commerce Drive
Schaumburg, IL 60173

1-800-55-OMRON

OMRON ON-LINE

Global - <http://www.omron.com>
USA - <http://www.omron.com/oei>
Canada - <http://www.omron.com/oci>

OMRON CANADA, INC.

885 Milner Avenue
Scarborough, Ontario M1B 5V8
416-286-6465