

Besondere Merkmale

- nicht eingefärbtes, klares Gehäuse
- antiparallel geschaltete Leuchtdiodenchips
- hohe Signalwirkung durch Farbwechsel der LED möglich
- bei geeigneter Ansteuerung mit IC (z.B. SDA 2231), Farbwechsel von grün über gelb und orange bis super-rot möglich
- beide Farben getrennt ansteuerbar
- gegurtet lieferbar
- Störimpulsfest nach DIN 40839

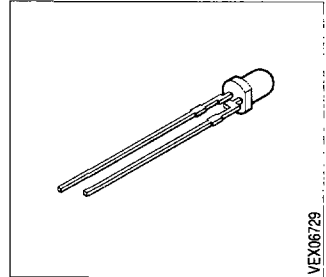

Features

- colorless clear plastic package
- antiparallel chips
- high signal efficiency possible by color change of the LED
- with appropriate controlling by IC (e.g. SDA2231) it is possible to change color from green to yellow, orange and super-red
- both colors can be controlled separately
- available taped on reel
- load dump resistant acc. to DIN 40839

Typ Type	Emissionsfarbe Color of Emission	Gehäusefarbe Color of Package	Lichtstärke Luminous Intensity $I_F = 10 \text{ mA}$ I_V (mcd)	Bestellnummer Ordering Code
LSG 3331-JO ¹⁾	super-red / green	colorless clear	≥ 4 (18 typ.)	Q62703-Q2296

Streuung der Lichtstärke in einer Verpackungseinheit $I_{V \max} / I_{V \min} \leq 2.0^{1)}$.

Streuung der Lichtstärke in einer LED $I_{V \max} / I_{V \min} \leq 3.0$.

¹⁾ Bei MULTILED® bestimmt die Helligkeit des jeweils dunkleren Chip in einem Gehäuse die Helligkeitsgruppe der LED.

Luminous intensity ratio in one packaging unit $I_{V \max} / I_{V \min} \leq 2.0^{1)}$.

Luminous intensity ratio in one LED $I_{V \max} / I_{V \min} \leq 3.0$.

¹⁾ In case of MULTILED®, the brightness of the darker chip in one package determines the brightness group of the LED.

Grenzwerte¹⁾Maximum Ratings¹⁾

Bezeichnung Parameter	Symbol Symbol	Werte Values	Einheit Unit
Betriebstemperatur Operating temperature range	T_{op}	- 55 ... + 100	°C
Lagertemperatur Storage temperature range	T_{stg}	- 55 ... + 100	°C
Sperrschichttemperatur Junction temperature	T_j	+ 100	°C
Durchlaßstrom Forward current	I_F	40	mA
Stoßstrom Surge current $t \leq 10 \mu s, D = 0.005$	I_{FM}	0.5	A
Verlustleistung Power dissipation $T_A \leq 25 \text{ °C}$	P_{tot}	140	mW
Wärmewiderstand Thermal resistance Sperrschicht / Luft Junction / air	R_{thJA}	400	K/W

¹⁾ Die angegebenen Grenzdaten gelten für den Chip, für den sie angegeben sind, unabhängig vom Betriebszustand des anderen.

¹⁾ The standard maximum ratings refer to the specified chip regardless of the other one's operating status.

Kennwerte ($T_A = 25\text{ °C}$)
Characteristics

Bezeichnung Parameter	Symbol Symbol	Werte Values		Einheit Unit
		LS	LG	
Wellenlänge des emittierten Lichtes Wavelength at peak emission $I_F = 20\text{ mA}$	(typ.) λ_{peak} (typ.)	635	565	nm
Dominantwellenlänge Dominant wavelength $I_F = 20\text{ mA}$	(typ.) λ_{dom} (typ.)	628	570	nm
Spektrale Bandbreite bei 50 % $I_{\text{rel max}}$ Spectral bandwidth at 50 % $I_{\text{rel max}}$ $I_F = 20\text{ mA}$	(typ.) $\Delta\lambda$ (typ.)	45	25	nm
Abstrahlwinkel bei 50 % I_V (Vollwinkel) Viewing angle at 50 % I_V	2φ	40	40	Grad deg.
Durchlaßspannung Forward voltage $I_F = 10\text{ mA}$	(typ.) V_F (max.) V_F	2.0 2.6	2.0 2.6	V V
Kapazität Capacitance $V_R = 0\text{ V}, f = 1\text{ MHz}$	(typ.) C_0	27		pF
Schaltzeiten: Switching times:				
I_V from 10 % to 90 %	(typ.) t_r	300	450	ns
I_V from 90 % to 10 %	(typ.) t_f	150	200	ns
$I_F = 100\text{ mA}, t_p = 10\text{ }\mu\text{s}, R_L = 50\text{ }\Omega$				

Relative spektrale Emission $I_{rel} = f(\lambda)$, $T_A = 25\text{ }^\circ\text{C}$, $I_F = 20\text{ mA}$

Relative spectral emission

$V(\lambda)$ = spektrale Augenempfindlichkeit

Standard eye response curve

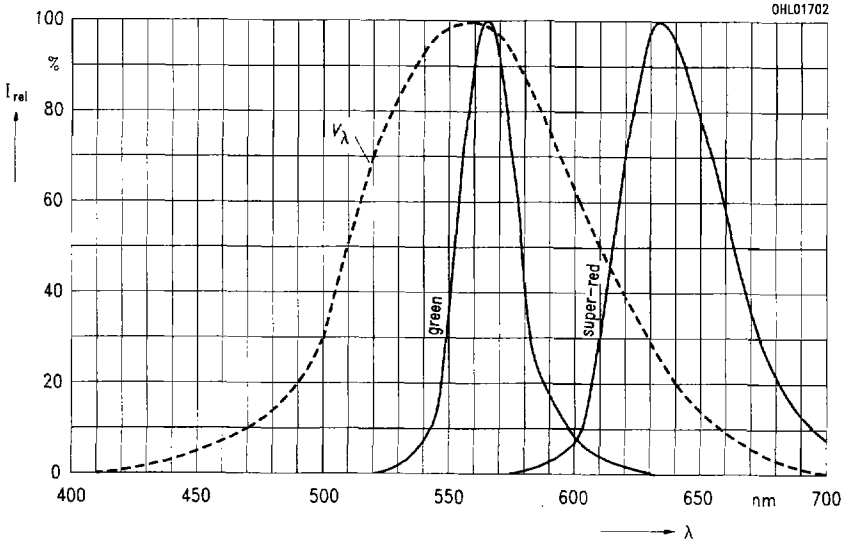

Abstrahlcharakteristik $I_{rel} = f(\varphi)$

Radiation characteristic

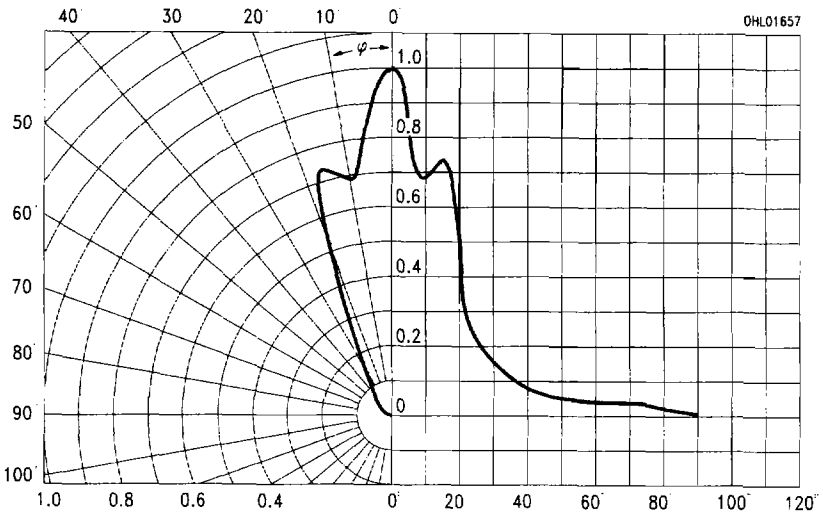

Durchlaßstrom $I_F = f(V_F)$

Forward current

$T_A = 25^\circ\text{C}$

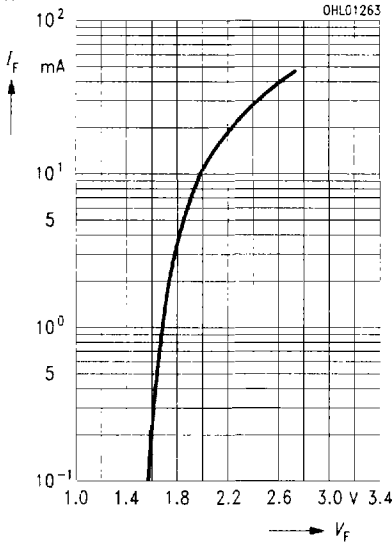

Relative Lichtstärke $I_V/I_{V(10\text{mA})} = f(I_F)$

Relative luminous intensity

$T_A = 25^\circ\text{C}$

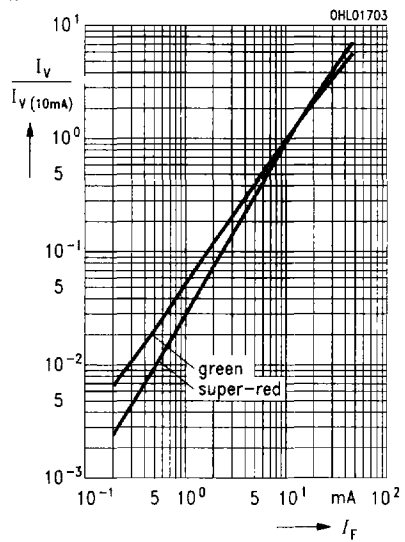

Zulässige Impulsbelastbarkeit $I_F = f(t_p)$

Permissible pulse handling capability

Duty cycle $D =$ parameter, $T_A = 25^\circ\text{C}$

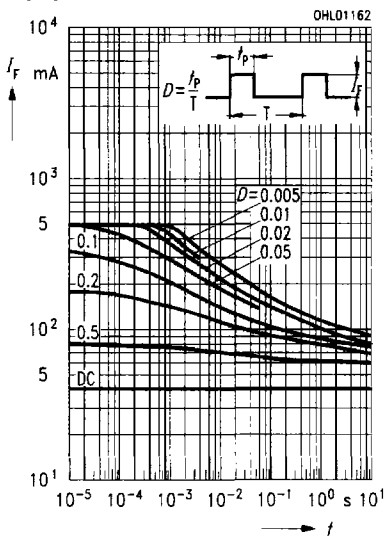

Maximal zulässiger Durchlaßstrom

Max. permissible forward current

$I_F = f(T_A)$

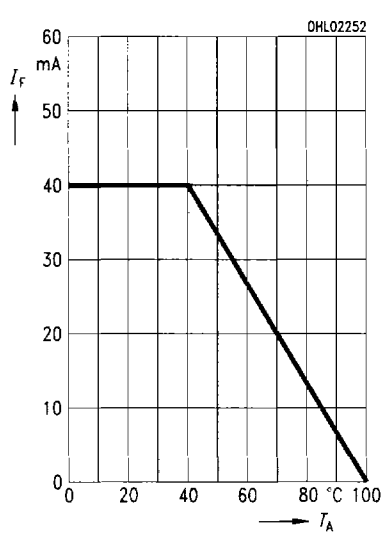

Wellenlänge der Strahlung $\lambda_{\text{peak}} = f(T_A)$
Wavelength at peak emission

$I_F = 20 \text{ mA}$

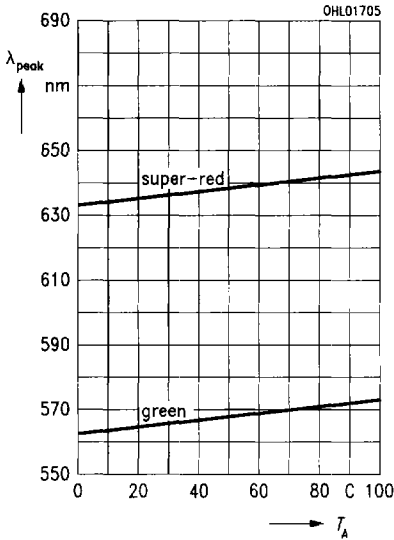

Dominantwellenlänge $\lambda_{\text{dom}} = f(T_A)$
Dominant wavelength

$I_F = 20 \text{ mA}$

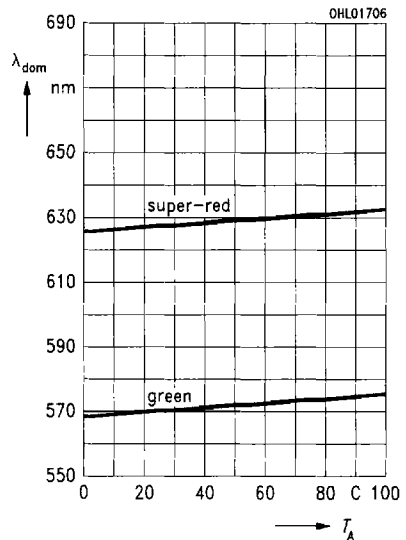

Durchlaßspannung $V_F = f(T_A)$
Forward voltage

$I_F = 10 \text{ mA}$

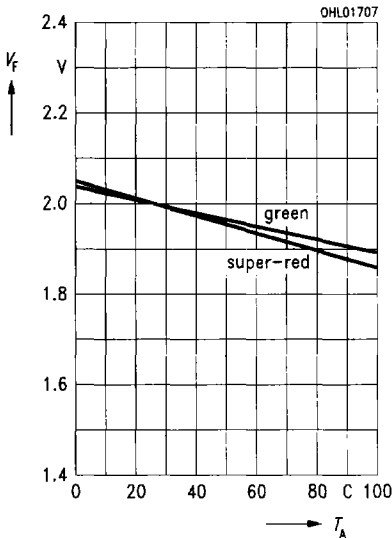

Relative Lichtstärke $I_V/I_{V(25^\circ\text{C})} = f(T_A)$
Relative luminous intensity

$I_F = 10 \text{ mA}$

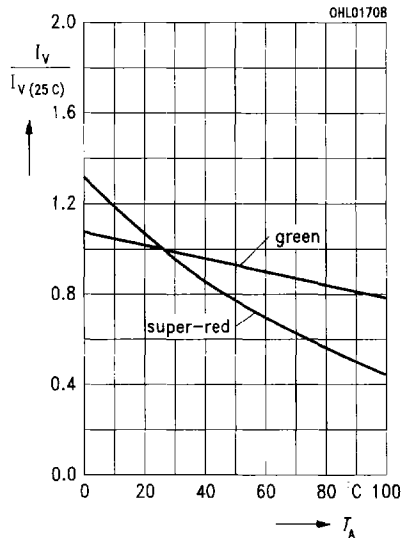

Maßzeichnung (Maße in mm, wenn nicht anders angegeben)
Package Outlines (Dimensions in mm, unless otherwise specified)

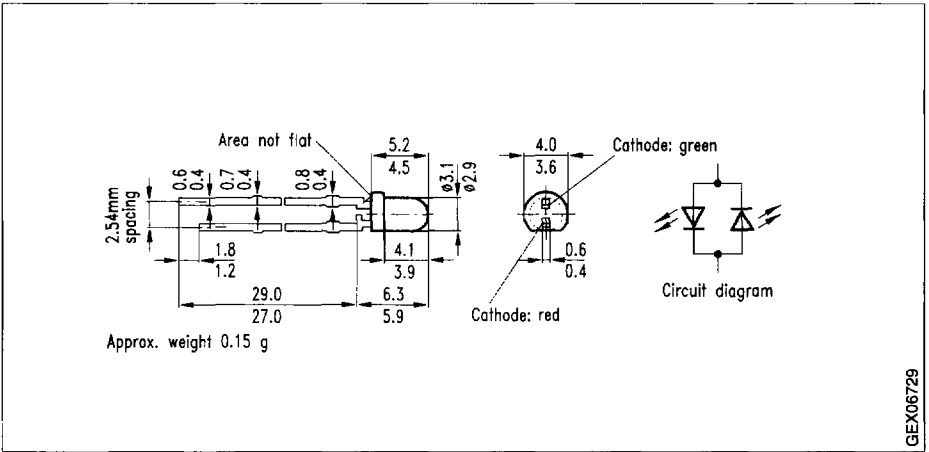

GEX06729

Kathodenkennzeichnung:

- grün: längerer Lötspieß
- rot: kürzerer Lötspieß

Cathode mark:

- green: long solder lead
- red: short solder lead