

Nominal diameter    Withdraw. force    Rated current    Contact resistance

Type    Part No

4 mm    -    32 A    0.3 mΩ



SLK 425-SI  
SLK 425-SI Sil

• PVC

Highly flexible safety patch cord with 4 mm (.160 in) dia. safety plugs with safety in-line socket 4 mm (.160 in) dia. Plugs machined brass, gold plated with MC®-Multilam™. Matching safety jacks 4 mm (.160 in) dia. PVC or silicone insulated wire 2.5 mm<sup>2</sup> (13 AWG).



- 28.0105-02! (25 cm)
- 28.0105-05! (50 cm)
- 28.0105-07! (75 cm)
- 28.0105-10! (100 cm)
- 28.0105-15! (150 cm)
- 28.0105-20! (200 cm)

For operating temperatures, see page 27.

Components and ratings for SLK 425-SI:

- Multilam™ plug LS 425-SK ..... # 22.1022
- Insulator (polyamide) KT 425-SI ..... # 22.2350
- Wire Flexi-2V/HK 2.5-D ..... # 60.7033
- Rated voltage: ..... 600 V
- Insulation coordination: ..... 4000 V/2
- Test voltage: ..... 4000 V

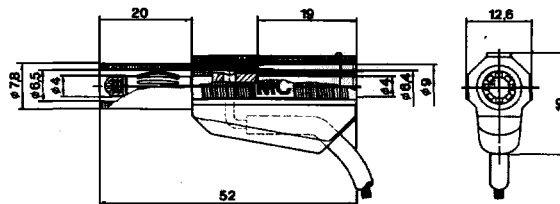

• Silicone

- 28.0106-02! (25 cm)
- 28.0106-05! (50 cm)
- 28.0106-07! (75 cm)
- 28.0106-10! (100 cm)
- 28.0106-15! (150 cm)
- 28.0106-20! (200 cm)

Components and ratings for SLK 425-SI Sil:

- Multilam™ plug LS 425-SK ..... # 22.1022
- Insulator (polyamide) KT 425-SI ..... # 22.2350
- Wire Sili-E/HK 2.5 ..... # 61.7556
- Rated voltage: ..... 600 V
- Insulation coordination: ..... 4000 V/2
- Test voltage: ..... 2000 V

1:1.5

Colors: • PVC: 20 - 29 • Sil: 21 - 25

LS 425-SK

KT 425-SI

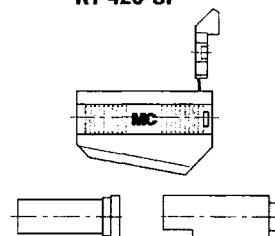
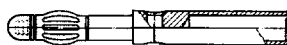

1:1.3

Multi-Contact's patch cords are available in a wide assortment of colors and lengths. Certain patch cords are available with either silicone or PVC insulated wire or with nickel or gold plated contacts.

If any of our stock patch cords do not fit your needs, please call us and we will custom manufacture to your specifications.

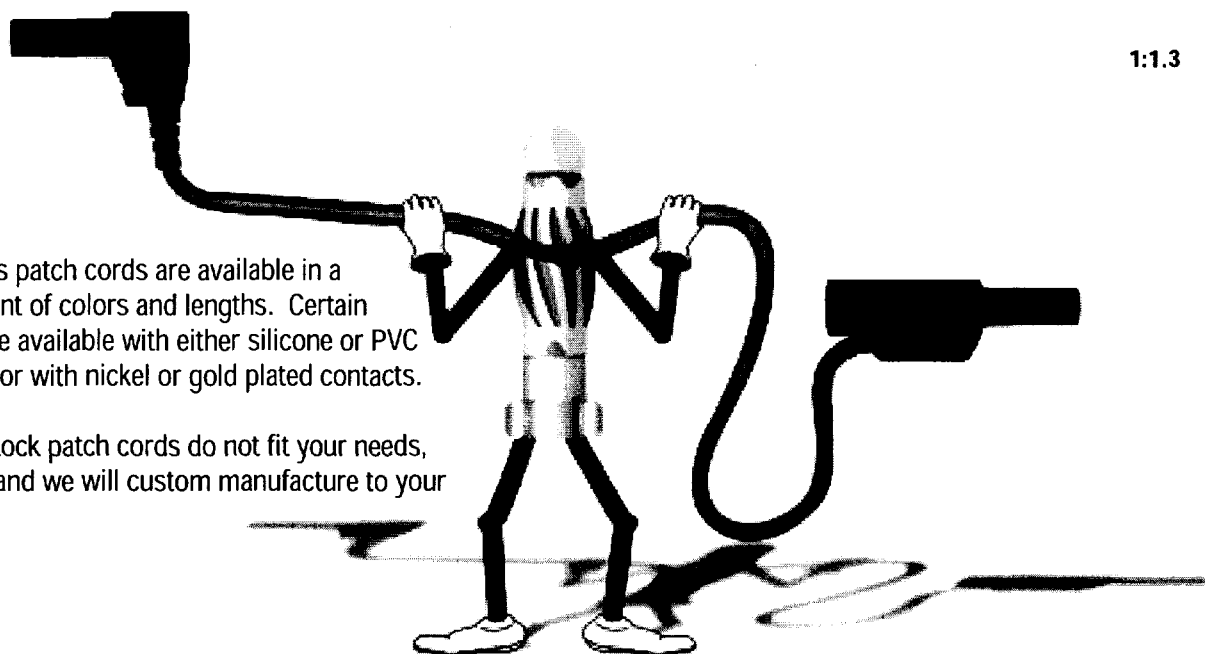

- 20 - green/yellow    21 - black    22 - red    23 - blue    24 - yellow    25 - green    26 - violet    27 - brown    28 - gray    29 - white    33 - transparent

# 4 mm Safety Patch Cords

Part No.	Type	Nominal diameter	Withdraw. force	Rated current	Contact resistance
----------	------	------------------	-----------------	---------------	--------------------

8.0107-025  
25 cm)

8.0107-050  
50 cm)

8.0107-075  
75 cm)

8.0107-100  
100 cm)

8.0107-150  
150 cm)

8.0107-200  
200 cm)

SLK 425-UL



4 mm      -      35 A      0.3 mΩ

Highly flexible safety patch cord with 4 mm (.160 in) dia. safety plugs with safety in-line socket 4 mm (.160 in) dia. Plugs machined brass, gold plated with MC®-Multilam™. Matching safety jacks 4 mm (.160 in) dia. PVC insulated wire 2.5 mm<sup>2</sup> (13 AWG).

For operating temperatures, see page 27.

- Components and ratings:  
 Plug and insulator without UL-identification.
- Multilam™ plug LS 425-SK ..... # 22.1022
  - Insulator (polyamide)KT 425-SU ..... # 22.2290
  - Wire HK 2.5-UL PVC ..... # 22.0140
  - Rated voltage ..... 500 V
  - Test voltage ..... 2000 V

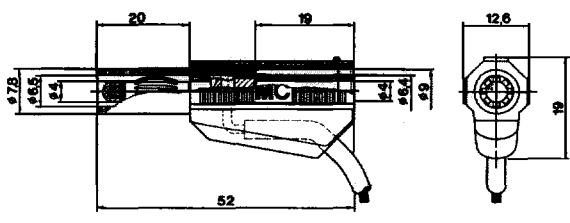

LS 425-SK

KT 425-SU

1:1.5

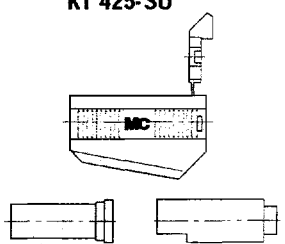

1:1.5

Colors: 20 - 25

UL-listed No. 353 Z

8.0097-025  
25 cm)

8.0097-050  
50 cm)

8.0097-075  
75 cm)

8.0097-100  
100 cm)

8.0097-150  
150 cm)

8.0097-200  
200 cm)

SLK 410-SI Sil

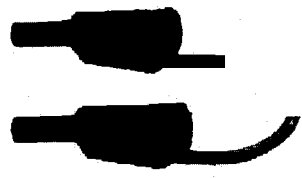

4 mm      -      19 A      0.3 mΩ

Highly flexible safety patch cord with 4 mm (.160 in) dia. safety plugs with safety in-line socket 4 mm (.160 in) dia. Plugs machined brass, gold plated with MC®-Multilam™. Matching safety jacks 4 mm (.160 in) dia. Silicone insulated wire 1.0 mm<sup>2</sup> (17 AWG).

For operating temperatures, see page 27.

- Components and ratings:
- Multilam™ plug LS 425-SK ..... # 22.1022
  - Insulator (polyamide) KT 425-SI ..... # 22.2350
  - Wire Sili-1V 1.0 ..... # 61.7607
  - Rated voltage: ..... 600 V
  - Insulation coordination: ..... 4000 V/2
  - Test voltage: ..... 3500 V

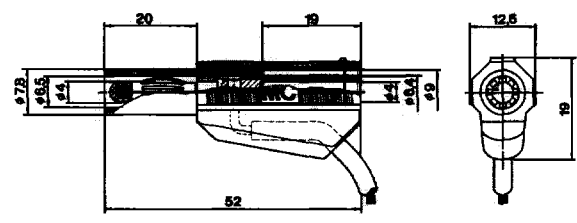

LS 425-SK

KT 425-SI

1:1.5

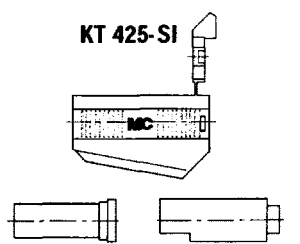
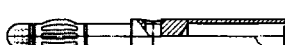

1:1.5

Colors: 21 - 23

20 - green/yellow    21 - black    22 - red    23 - blue    24 - yellow    25 - green    26 - violet    27 - brown    28 - gray    29 - white    33 - transparent

Nominal diameter 4 mm  
 Withdraw. force -  
 Rated current 19 A  
 Contact resistance 0.8 mΩ

Type

Part No

Highly flexible safety patch cord assembled with stackable safety plugs on both ends. Available with either PVC (XVF-446) or silicone (XVS-446) cable. Plugs are brass, nickel plated.

Components and ratings:

- Multilam™ plug XLS-446 ..... # 66.1010
- Insulator (polyamide) XKT-446 ..... # 66.1009
- Wire FLEXI-2V 1.0 PVC (XVF-446) ..... # 60.7030
- Wire SILI-1V 1.0 Silicone (XVS-446) ..... # 61.7607
- Rated voltage: ..... 600 V, CAT II

Colors: 20 - 27, 29

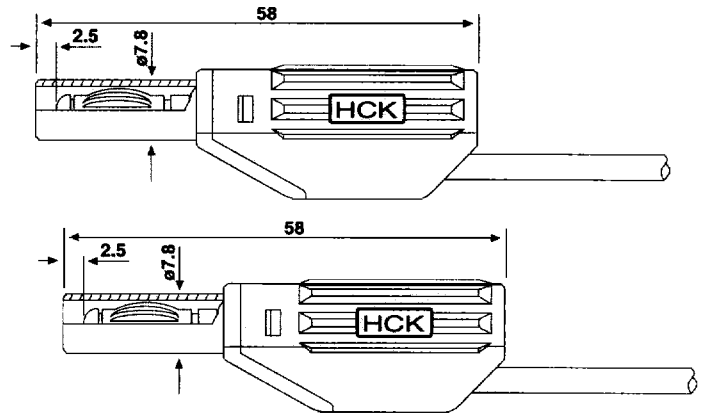

1:1

XLS-446

XKT-446

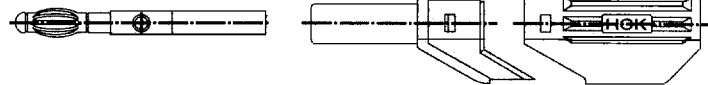

1:1.3

XVF-446  
XVS-446

- PVC
- 66.9738-02! (25 cm)
- 66.9738-05! (50 cm)
- 66.9738-10! (100 cm)
- 66.9738-15! (150 cm)
- 66.9738-20! (200 cm)
- Silicone
- 66.9739-02! (25 cm)
- 66.9739-05! (50 cm)
- 66.9739-10! (100 cm)
- 66.9739-15! (150 cm)
- 66.9739-20! (200 cm)

Nominal diameter 4 mm  
 Withdraw. force -  
 Rated current 32 A  
 Contact resistance 0.8 mΩ

Highly flexible safety patch cord assembled with stackable safety plugs on both ends. Available with either PVC (XVF-448) or silicone (XVS-448) cable. Plugs are brass, nickel plated.

Components and ratings:

- Multilam™ plug XLS-446 ..... # 66.1010
- Insulator (polyamide) XKT-446 ..... # 66.1009
- Wire FLEXI-2V/HK2.5-D (XVF-448) ..... # 60.7033
- Wire SILI-E/HK 2.5 Silicone (XVS-448) ..... # 61.7556
- Rated voltage: ..... 600 V, CAT II

Colors: 20 - 27, 29

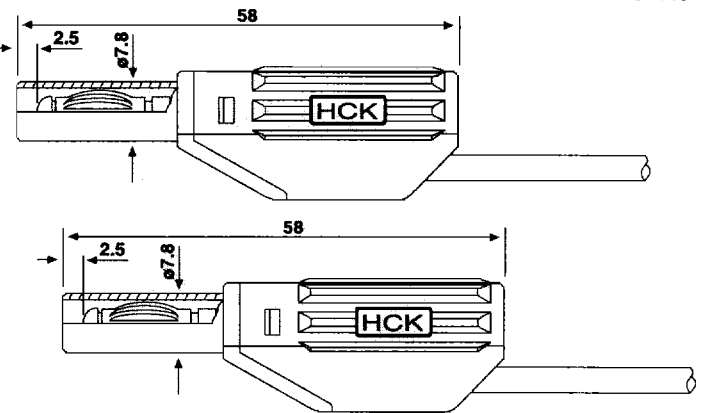

1:1

XLS-446

XKT-446



1:1.3

XVF-448  
XVS-448

- PVC
- 66.9736-02! (25 cm)
- 66.9736-05! (50 cm)
- 66.9736-10! (100 cm)
- 66.9736-15! (150 cm)
- 66.9736-20! (200 cm)
- Silicone
- 66.9737-02! (25 cm)
- 66.9737-05! (50 cm)
- 66.9737-10! (100 cm)
- 66.9737-15! (150 cm)
- 66.9737-20! (200 cm)

20 - green/yellow 21 - black 22 - red 23 - blue 24 - yellow 25 - green 26 - violet 27 - brown 28 - gray 29 - white 33 - transparent

# 4 mm Safety Patch Cords

Part No.	Type	Nominal diameter	Withdraw. force	Rated current	Contact resistance
----------	------	------------------	-----------------	---------------	--------------------

18.0121-025  
25 cm)

18.0121-050  
50 cm)

18.0121-075  
75 cm)

18.0121-100  
100 cm)

18.0121-150  
150 cm)

18.0121-200  
200 cm)

SLK 425-F

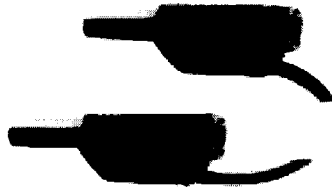

4 mm

–

32 A

0.3 mΩ

Highly flexible safety patch cord assembled with stackable safety plugs on both ends. Plugs are brass, gold plated.

Components and ratings:

- Multilam™ plug LS 425-SK ..... # 22.1022
- Insulator (polyamide) KT 425-SF ..... # 22.2310
- Wire FLEXI-2V/HK 2.5-D PVC ..... # 60.7033
- Lead cross section: ..... 2.5 mm<sup>2</sup>
- Lead insulation: ..... PVC
- Rated voltage: ..... 1000 V, CAT III

Colors: 20 - 27, 29

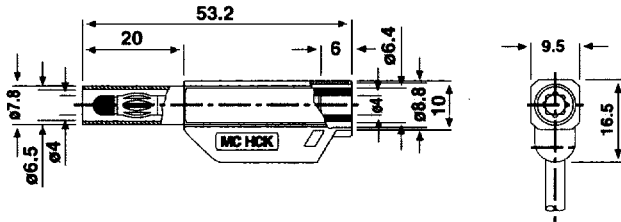

1:1.3

LS 425-SK

KT 425-SF

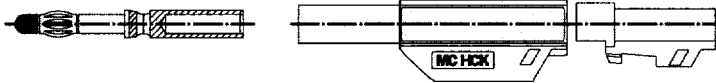

1:1.3

19.0002-025  
25 cm)

19.0002-050  
50 cm)

19.0002-075  
75 cm)

19.0002-100  
100 cm)

19.0002-150  
150 cm)

19.0002-200  
200 cm)

SLK 425-F/N

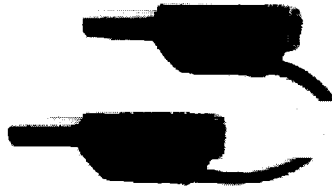

4 mm

–

32 A

0.8 mΩ

Highly flexible safety patch cord assembled with stackable safety plugs on both ends. Plugs are brass, nickel plated.

Components and ratings:

- Multilam™ plug LS 425-SK/N ..... # 22.6242
- Insulator (polyamide) KT 425-SF ..... # 22.2310
- Wire FLEXI-2V/HK 2.5-D PVC ..... # 60.7033
- Lead cross section: ..... 2.5 mm<sup>2</sup>
- Lead insulation: ..... PVC
- Rated voltage: ..... 1000 V, CAT III

Colors: 20 - 27, 29

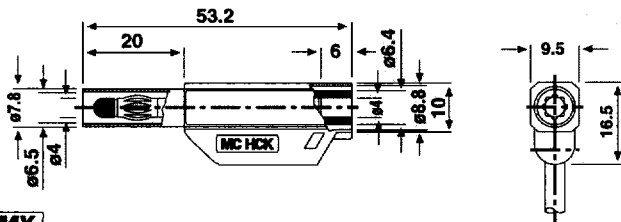

1:1.3

LS 425-SK/N

KT 425-SF

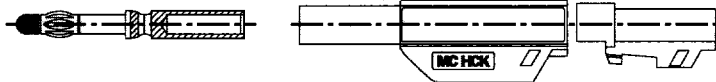

1:1.3

20 - green/yellow 21 - black 22 - red 23 - blue 24 - yellow 25 - green 26 - violet 27 - brown 28 - gray 29 - white 33 - transparent

Nominal diameter    Withdraw. force    Rated current    Contact resistance

4 mm                      -                      15 A                      0.8 mΩ



Highly flexible safety patch cord assembled with stackable safety plugs on both ends. Plugs are brass, nickel plated.

Components and ratings:

- Multilam™ plug LS 425-SK/N ..... # 22.6242
- Insulator (polyamide) KT 425-SF ..... # 22.2310
- Wire FLEXI-2V/HKO.75-D PVC ..... # 60.7941
- Lead cross section: ..... 0.75 mm<sup>2</sup>
- Lead insulation: ..... PVC
- Rated voltage: ..... 1000 V, CAT III

Colors: 21 - 27, 29

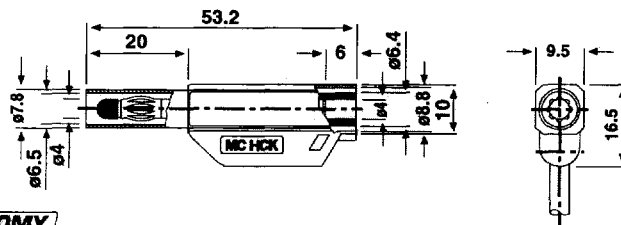
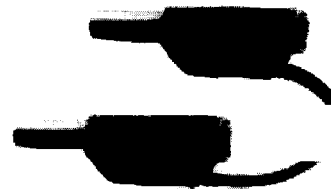

1:1.3

SLK 4075-F/N 28.0123-02! (25 cm)

28.0123-05! (50 cm)

28.0123-07! (75 cm)

28.0123-10! (100 cm)

28.0123-15! (150 cm)

28.0123-20! (200 cm)

LS 425-SK/N

KT 425-SF

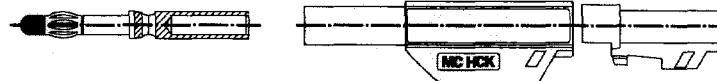

1:1.3

4 mm                      -                      19 A                      0.3 mΩ



Highly flexible safety patch cord assembled with stackable safety plugs on both ends. Plugs are brass, gold plated.

Components and ratings:

- Multilam™ plug LS 425-SK ..... # 22.1022
- Insulator (polyamide) KT 425-SF ..... # 22.2310
- Wire SILI-1V 1.0 Silicone ..... # 61.7607
- Lead cross section: ..... 1.0 mm<sup>2</sup>
- Lead insulation: ..... Silicone
- Rated voltage: ..... 1000 V, CAT III

Colors: 21 - 23

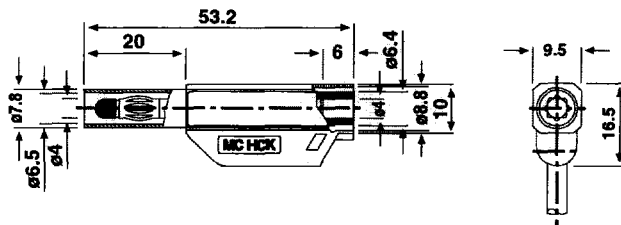
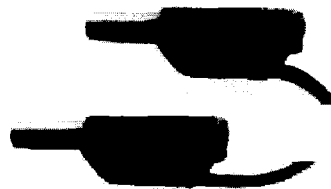

1:1.3

SLK 410-F Sil 28.0122-02! (25 cm)

28.0122-05! (50 cm)

28.0122-07! (75 cm)

28.0122-10! (100 cm)

28.0122-15! (150 cm)

28.0122-20! (200 cm)

LS 425-SK

KT 425-SF



1:1.3

20 - green/yellow    21 - black    22 - red    23 - blue    24 - yellow    25 - green    26 - violet    27 - brown    28 - gray    29 - white    33 - transparent

# 4 mm Safety Patch Cords

Part No.	Type	Nominal diameter	Withdraw. force	Rated current	Contact resistance
----------	------	------------------	-----------------	---------------	--------------------

19.0137-025  
25 cm) SLK 425-T/N

4 mm - 32 A<sup>1)</sup> -

19.0137-050  
50 cm)

19.0137-075  
75 cm)

19.0137-100  
100 cm)

19.0137-150  
150 cm)

19.0137-200  
200 cm)

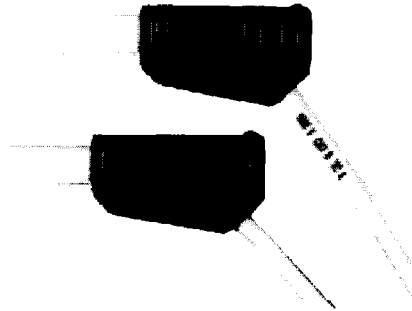

**Electrostatic discharge** connecting leads to equip test and work stations for protection from electrostatic charging. Brass, nickel plated.  
To be used with our ESD panel mount jacks on pages 190 - 191 and 248 - 249.

• For safety reasons, these leads are **not** compatible with the 4 mm safety system.

Components and ratings:

- Wire FLEXI-2V/HK 2.5-D PVC ..... # 60.7033-20
- Lead cross section: ..... 2.5 mm<sup>2</sup>
- Lead insulation: ..... PVC
- Rated voltage: ..... 600 V, CAT II<sup>1)</sup>

Colors: 20

<sup>1)</sup> for use as grounding lead.

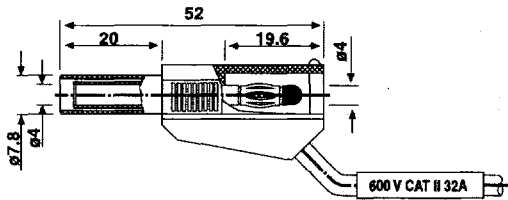

1:1.3

PVC XMF-482  
XMS-482



4 mm - 15 A 0.8 mΩ

i6.9636-050  
50 cm)

i6.9636-100  
100 cm)

i6.9636-150  
150 cm)

i6.9636-200  
200 cm)

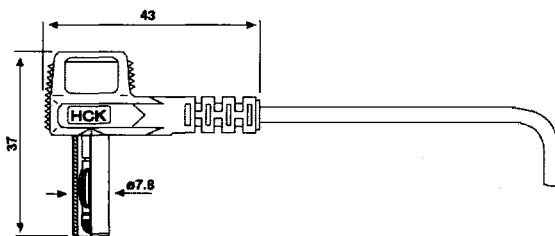

Highly flexible safety test lead with a 4 mm (.160 in) diameter safety plug on one end and a right-angled 4 mm (.160 in) diameter safety plug on the other. Available with either PVC insulated wire 0.75 mm<sup>2</sup> (XMF-482) or silicone insulated wire 0.75 mm<sup>2</sup> (XMS-482). Plugs are brass, nickel plated. Polyamide insulated.

Components and ratings:

- Rated voltage: ..... 1000 V, CAT II
- Wire FLEXI-2V 0.75 PVC ..... # 60.7028
- Wire SILI-1V 0.75 silicone ..... # 61.7606

Colors: 21 - 23

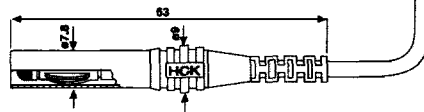

Silicone

i6.9637-050  
50 cm)

i6.9637-100  
100 cm)

i6.9637-150  
150 cm)

i6.9637-200  
200 cm)



1:1.3

20 - green/yellow 21 - black 22 - red 23 - blue 24 - yellow 25 - green 26 - violet 27 - brown 28 - gray 29 - white 33 - transparent

Nominal diameter	Withdraw. force	Rated current	Contact resistance
4 mm	-	32 A	0.8 mΩ 0.3 mΩ



SLK 425-K/W-TF  
SLK 425-K/WA-TF

• Nickel Plated

Highly flexible safety patch cord with 4 mm (.160 in) dia. safety plugs with safety in-line socket 4 mm (.160 in) dia. Plugs machined brass, nickel or gold plated with MC®-Multilam™. Matching safety jacks 4 mm (.160 in) dia. Thermoflex-insulated wire 2.5 mm² (13 AWG).

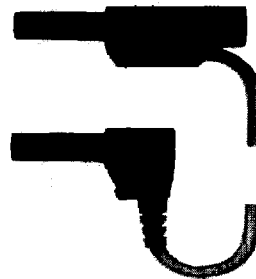

- 28.0086-02I (25 cm)
- 28.0086-05I (50 cm)
- 28.0086-10I (100 cm)
- 28.0086-15I (150 cm)
- 28.0086-20I (200 cm)

For operating temperatures, see page 27.

Components and ratings for SLK 425-K/W-TF:

- Multilam™ plug LS 425-SK/N ..... # 22.6242
- Multilam™ plug LS 425-SW ..... # 22.1042
- Insulator (polyamide) KT 425-SK ..... # 22.2300
- Insulator (polyamide) KT 425-SW ..... # 22.2370
- Wire HK 2.5-D/TF Thermoflex ..... # 22.0180 (double insul.)
- Rated voltage: ..... 500 V, CAT II

• Gold Plated

- 28.0087-02I (25 cm)
- 28.0087-05I (50 cm)
- 28.0087-10I (100 cm)
- 28.0087-15I (150 cm)
- 28.0087-20I (200 cm)

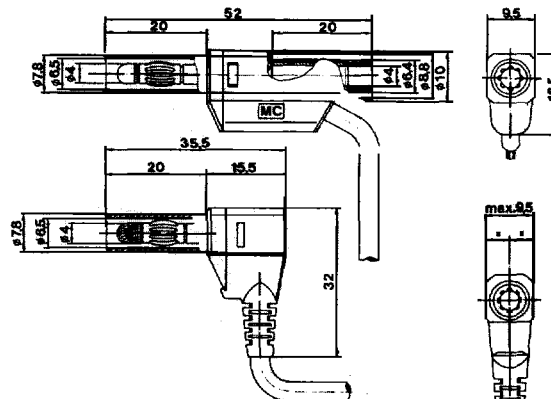

Components and ratings for SLK 425-K/WA-TF:

- Multilam™ plug LS 425-SK ..... # 22.1022
- Multilam™ plug LS 425-SW/A ..... # 22.1045
- Insulator (polyamide) KT 425-SK ..... # 22.2300
- Insulator (polyamide) KT 425-SW ..... # 22.2370
- Wire HK 2.5-D/TF Thermoflex ..... # 22.0180 (double insul.)
- Rated voltage: ..... 500 V, CAT II

1:1.5

Colors: 21 - 26

LS 425-SK/N, LS 425-SK



KT 425-SK

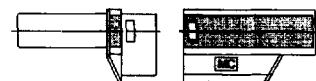

LK 425-SW, LS 425-SW/A

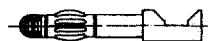

KT 425-SW

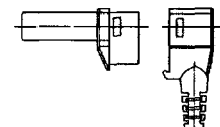

1:1.5

20 - green/yellow 21 - black 22 - red 23 - blue 24 - yellow 25 - green 26 - violet 27 - brown 28 - gray 29 - white 33 - transparent

# 4 mm Safety Patch Cords

Part No.	Type	Nominal diameter	Withdraw. force	Rated current	Contact resistance
----------	------	------------------	-----------------	---------------	--------------------

18.0092-100  
nickel plated)  
100 cm)

18.0093-100  
gold plated)  
100 cm)

SLK 425-W  
SLK 425-W/A

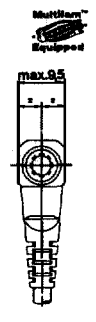
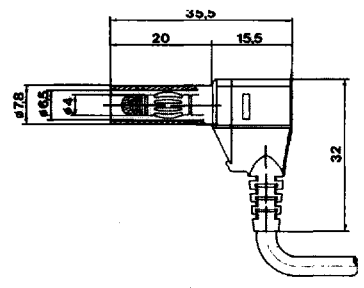
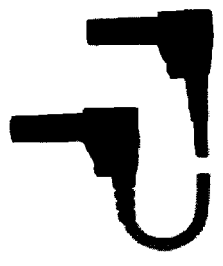

1:1.5

Highly flexible safety patch cord with 4 mm (.160 in) dia. safety plugs. Plugs machined brass, nickel or gold plated with MC\*-Multilam™. Matching safety jacks 4mm (.160 in) dia. PVC insulated wire 2.5 mm<sup>2</sup> (13 AWG).

For operating temperatures, see page 27.

- Components and ratings:
- Multilam™ plug LS 425-SW ..... # 22.1042
  - Multilam™ plug LS 425-SW/A ..... # 22.1045
  - Insulator (polyamide) KT 425-SW ..... # 22.2370
  - Wire Flexi-2V/HK 2.5-D ..... # 60.7033
  - Rated voltage: ..... 500 V, CAT II

Colors: 20 - 26

LS 425-SW, LS 425-SW/A

KT 425-SW

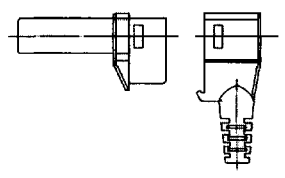

1:1

18.0094-100  
nickel plated)  
100 cm)

18.0095-100  
gold plated)  
100 cm)

SLK 425-W/TF  
SLK 425-WA/TF

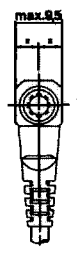
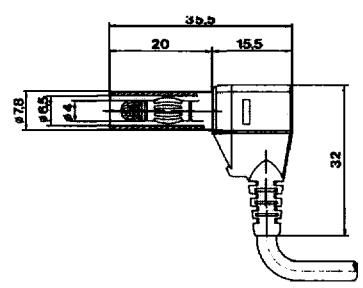
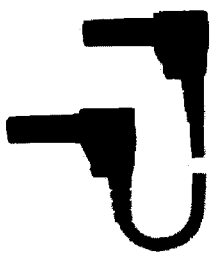

1:1.5

Highly flexible safety patch cord with 4 mm (.160 in) dia. safety plugs with safety in-line socket 4 mm (.160 in) dia. Plugs machined brass, nickel or gold plated with MC\*-Multilam™. Matching safety jacks 4 mm (.160 in) dia. Thermoflex insulated wire 2.5 mm<sup>2</sup> (13 AWG).

For operating temperatures, see page 27.

- Components for SLK 425-W/TF (nickel plated):
- Multilam™ plug LS 425-SW ..... # 22.1042
  - Insulator (polyamide) KT 425-SW ..... # 22.2370
  - Wire HK 2.5-D/TF Thermoflex ..... # 22.0180
  - Rated voltage: ..... 500 V, CAT II

- Components for SLK 425-WA/TF (gold plated):
- Multilam™ plug LS 425-SW/A ..... # 22.1045
  - Insulator (polyamide) KT 425-SW ..... # 22.2370
  - Wire HK 2.5-D/TF Thermoflex ..... # 22.0180
  - Rated voltage: ..... 500 V, CAT II

Colors: 21 - 26

LS 425-SW, LS 425-SW/A

KT 425-SW

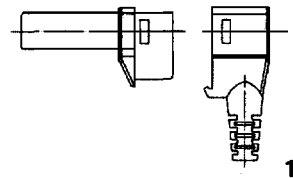

1:1

20 - green/yellow 21 - black 22 - red 23 - blue 24 - yellow 25 - green 26 - violet 27 - brown 28 - gray 29 - white 33 - transparent



Nominal diameter	Withdraw. force	Rated current	Contact resistance
4 mm	-	32 A	0.8 mΩ 0.3 mΩ



SLK 425-L/W  
SLK 425-L/WA

28.0090-10X  
(nickel plated  
100 cm)  
28.0091-10X  
(gold plated  
100 cm)

Highly flexible safety patch cord with 4 mm (.160 in) dia. safety plugs. Plugs machined brass, nickel or gold plated with MC®-Multilam™. Matching safety jacks 4 mm (.160 in) dia. PVC insulated wire 2.5 mm² (13 AWG).

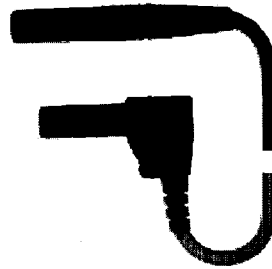

For operating temperatures, see page 27.

Components for SLK 425-L/W (nickel plated):

- Multilam™ plug LS 425-SL/N ..... # 22.1032
- Multilam™ plug LS 425-S/W ..... # 22.1042
- Insulator (polyamide) KT 425-SL ..... # 22.2260
- Insulator (polyamide) KT 425-SW ..... # 22.2370
- Wire Flexi-2V/HK 2.5-D ..... # 60.7033
- Rated voltage ..... 500 V, CAT II

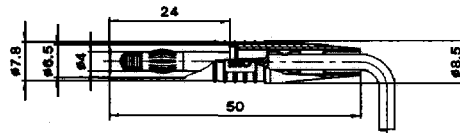

Components for SLK 425-L/WA (gold plated):

- Multilam™ plug LS 425-SL ..... # 22.1025
- Multilam™ plug LS 425-SW/A ..... # 22.1045
- Insulator (polyamide) KT 425-SL ..... # 22.2260
- Insulator (polyamide) KT 425-SW ..... # 22.2370
- Wire Flexi-2V/HK 2.5-D ..... # 60.7033
- Rated voltage ..... 500 V, CAT II

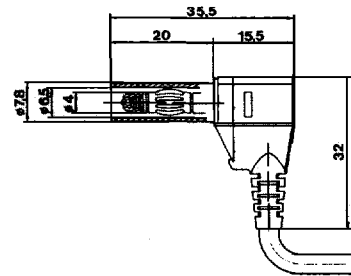

Colors: 21 - 23

1:1.5

LS 425-SL/N, LS 425-SL

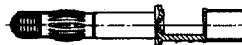

KT 425-SL



LS 425-SW, LS 425-SW/A

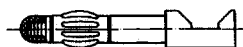

KT 425-SW

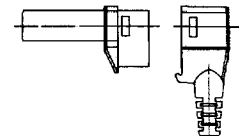

1:1.3

# 4 mm Safety Patch Cords

Part No.	Type	Nominal diameter	Withdraw. force	Rated current	Contact resistance
----------	------	------------------	-----------------	---------------	--------------------

- PVC**  
 i6.9005-050 (50 cm)  
 i6.9005-100 (100 cm)  
 i6.9005-150 (150 cm)  
 i6.9005-200 (200 cm)

- Silicone**  
 i6.9006-050 (50 cm)  
 i6.9006-100 (100 cm)  
 i6.9006-150 (150 cm)  
 i6.9006-200 (200 cm)

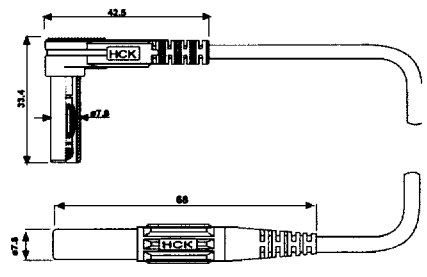

Highly flexible safety test lead with a 4 mm (.160 in) diameter safety plug on one end and a right-angled 4 mm (.160 in) diameter safety plug on the other. Available with either PVC insulated wire 1.00 mm<sup>2</sup> (XMF-484) or silicone insulated wire 1.00 mm<sup>2</sup> (XMS-484). Plugs are brass, nickel plated. Polyamide insulated.

- Components and ratings:  
 • Rated voltage: ..... 1000 V, CAT III  
 • Wire FLEXI-2V 1.0 PVC ..... # 60.7030  
 • Wire SILI-1V 1.0 silicone ..... # 61.7607

Colors: 21 - 26



1:1.3

- PVC**  
 28.0103-025 (25 cm)  
 28.0103-050 (50 cm)  
 28.0103-075 (75 cm)  
 28.0103-100 (100 cm)  
 28.0103-150 (150 cm)  
 28.0103-200 (200 cm)

- Silicone**  
 28.0104-025 (25 cm)  
 28.0104-050 (50 cm)  
 28.0104-075 (75 cm)  
 28.0104-100 (100 cm)  
 28.0104-150 (150 cm)  
 28.0104-200 (200 cm)

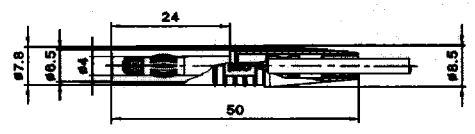
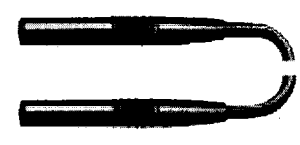

Part No.	Type	Nominal diameter	Withdraw. force	Rated current	Contact resistance
----------	------	------------------	-----------------	---------------	--------------------

Highly flexible safety patch cord with 4 mm (.160 in) dia. safety plugs. Plugs machined brass, gold plated with MC<sup>®</sup>-Multilam<sup>™</sup>. Matching safety jacks 4 mm (.160 in) dia. PVC or silicone insulated wire 2.5 mm<sup>2</sup> (13 AWG).

For operating temperatures, see page 27.

- Components and ratings for SLK 425-L:  
 • Multilam<sup>™</sup> plug LS 425-SL ..... # 22.1025  
 • Insulator (polyamide) KT 425-SL ..... # 22.2260  
 • Wire Flexi-2V/HK 2.5-D ..... # 60.7033  
 • Rated voltage: ..... 500 V, CAT II

- Components and ratings SLK 425-L Sil:  
 • Multilam<sup>™</sup> plug LS 425-SL ..... # 22.1025  
 • Insulator (polyamide) KT 425-SL ..... # 22.2260  
 • Wire Sili-E/HK 2.5 ..... # 61.7556  
 • Rated voltage: ..... 500 V, CAT II

Colors: • PVC: 21 - 23 • Sil: 21 - 23

LS 425-SL

KT 425-SL

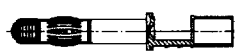

1:1.5

1:1.3

- 20 - green/yellow 21 - black 22 - red 23 - blue 24 - yellow 25 - green 26 - violet 27 - brown 28 - gray 29 - white 33 - transparent



# 4 mm Safety Patch Cords

Part No.	Type	Nominal diameter	Withdraw. force	Rated current	Contact resistance
----------	------	------------------	-----------------	---------------	--------------------

**PVC**  
 36.9634-050 (50 cm)  
 36.9634-100 (100 cm)  
 36.9634-150 (150 cm)  
 36.9634-200 (200 cm)

**SLK 418-L/6kV**



Multilam™ Equipped

4 mm      -      16 A      0.3 mΩ

Highly flexible safety patch cord with 4 mm (.160 in) dia. safety plugs, non-stacking. Plugs, machined brass, gold plated with MC®-Multilam™. Matching safety sockets and jacks 4 mm (.160 in) dia. PVC insulated 18 AWG wire.

For operating temperatures, see page 27.

- Components and ratings:
- Multilam™ plug LS 425-SL ..... # 22.1025
  - Insulator (polyamide) KT 425-SL ..... # 22.2260
  - Label sleeve ..... # 22.7120
  - Wire HK 18-H PVC ..... # 22.0110
  - Rated pulse voltage: ..... 6000 V, 1.2/50µs

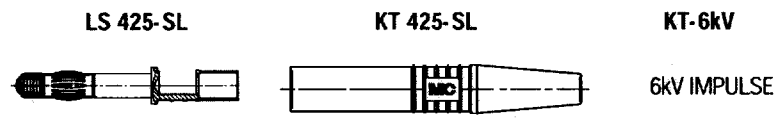
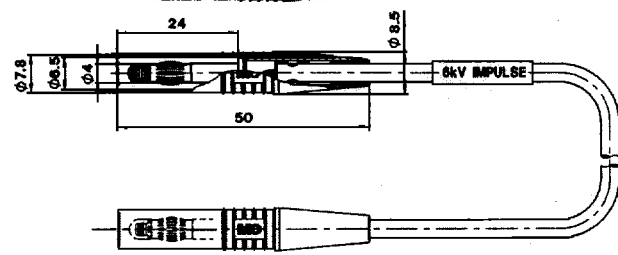

Colors: 21, 22

1:1.3

**PVC**  
 36.9634-050 (50 cm)  
 36.9634-100 (100 cm)  
 36.9634-150 (150 cm)  
 36.9634-200 (200 cm)

**XMF-402**  
**XMS-402**



Multilam™ Equipped

4 mm      -      15 A      0.8 mΩ

Highly flexible safety patch cord with 4 mm (.160 in) dia. safety plugs, non-stacking. Plugs, brass, nickel plated. Available with either PVC 0.75 mm² wire (XMF-402) or silicone 0.75 mm² wire. Polyamide insulated.

- Ratings:
- Rated voltage ..... 1000 V, CAT II
  - Wire FLEXI-2V 0.75 PVC ..... # 60.7028
  - Wire SILI-1V 0.75 silicone ..... # 61.7606

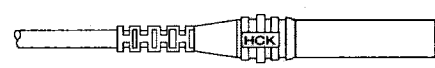
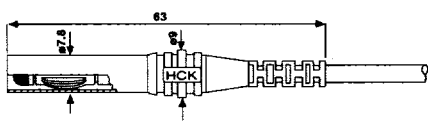

Colors: 21 - 23

1:1.3

**PVC**  
 36.9659-050 (50 cm)  
 36.9659-100 (100 cm)  
 36.9659-150 (150 cm)  
 36.9659-200 (200 cm)

**XKF-402**  
**XKS-402**



Multilam™ Equipped

4 mm      -      15 A      0.8 mΩ

Highly flexible safety coupling lead with a 4 mm (.160 in) dia. safety plug on one end and a 4 mm (.160 in) safety socket on the other. Brass, nickel plated. Available with either PVC 0.75 mm² wire (XKF-402) or silicone 0.75 mm² wire (XKS-402). Polyamide insulated.

- Ratings:
- Rated voltage ..... 1000 V, CAT II
  - Wire FLEXI-2V 0.75 PVC ..... # 60.7028
  - Wire SILI-1V 0.75 silicone ..... # 61.7606

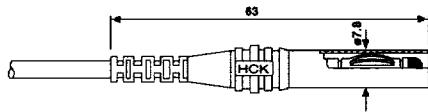
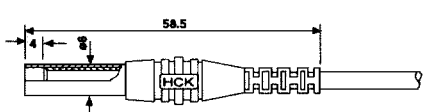

Colors: 21 - 23

1:1.3

20 - green/yellow    21 - black    22 - red    23 - blue    24 - yellow    25 - green    26 - violet    27 - brown    28 - gray    29 - white    33 - transparent

Nominal diameter    Withdraw. force    Rated current    Contact resistance

4 mm                      -                      19 A                      0.8 mΩ



Type                      Part No

XKF-414                      - PVC  
XKS-414                      66.9011-05f

Highly flexible safety coupling lead with a 4 mm (.160 in) dia. safety plug on one end and a 4 mm (.160 in) safety socket on the other. Brass, nickel plated. Available with either PVC 1.0 mm<sup>2</sup> wire (XKF-414) or silicone 1.0 mm<sup>2</sup> wire (XKS-414). Polyamide insulated.

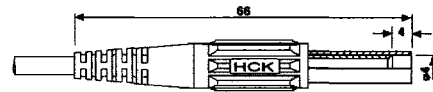
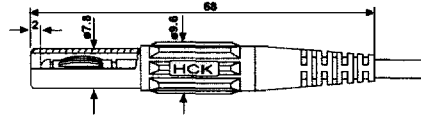

66.9011-10f (100 cm)  
66.9011-15f (150 cm)  
66.9011-20f (200 cm)

Ratings:  
• Rated voltage ..... 1000 V, CAT III  
• Wire FLEXI-2V 1.0 PVC ..... # 60.7030  
• Wire SILI-1V 1.0 silicone ..... # 61.7607

Colors: 21 - 26



1:1.3

4 mm                      -                      32 A<sup>1)</sup>                      -

SLK 425-BFT/N                      49.0130-02f

**Electrostatic discharge** connecting leads to equip test and work stations for protection from electrostatic charging. Brass, nickel plated. To be used with our ESD panel mount jacks on pages 190 - 191 and 248 - 249.



• For safety reasons, these leads are **not** compatible with the 4 mm safety system.



Components and ratings:  
• Wire FLEXI-1V 2.5 PVC ..... # 60.7125-20  
• Socket LS 425-BFT/N ..... # 49.7040  
• Insulator KT 425-SL/F ..... # 50.1109-24  
• Lead cross section ..... 2.5 mm<sup>2</sup>  
• Lead insulation ..... PVC  
• Rated voltage ..... 1000 V, CAT II <sup>1)</sup>  
• Operating temperature ..... -10° C to +70° C (14°F to 158°F)

49.0130-05f (50 cm)  
49.0130-07f (75 cm)

49.0130-10f (100 cm)

49.0130-15f (150 cm)

49.0130-20f (200 cm)

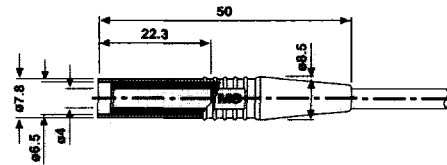

Colors: 20

<sup>1)</sup> for use as grounding lead.

1:1.3



7% of Ontario, Canada's electricity is produced by Niagara Falls.



20 - green/yellow    21 - black    22 - red    23 - blue    24 - yellow    25 - green    26 - violet    27 - brown    28 - gray    29 - white    33 - transparent