

## 5 mm (T1 3/4) LED, Diffused Wide-Angle LED

LR 5480, LS 5480, LY 5480  
LG 5480

### Besondere Merkmale

- eingefärbtes, diffuses Gehäuse
- als optischer Indikator einsetzbar
- Lötspieße ohne Aufsetzebene
- gegurtet lieferbar
- Störpulsfest nach DIN 40839

### Features

- colored, diffused package
- for use as optical indicator
- solder leads without stand-off
- available taped on reel
- load dump resistance acc. to DIN 40839

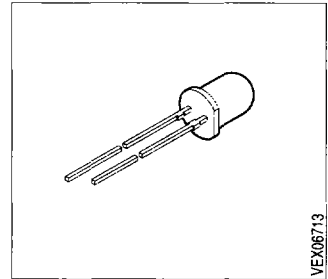

Typ Type	Emissionsfarbe Color of Emission	Gehäusefarbe Color of Package	Lichtstärke Luminous Intensity $I_F = 10 \text{ mA}$ $I_V$ (mcd)	Bestellnummer Ordering Code
LR 5480-CF LR 5480-E LR 5480-F LR 5480-DG	red	red diffused	0.25 ... 2.00 0.63 ... 1.25 1.00 ... 2.00 0.40 ... 3.20	Q62703-Q1986 Q62703-Q1734 Q62703-Q1987 Q62703-Q1408
LS 5480-GL LS 5480-J LS 5480-K LS 5480-L LS 5480-JM	super-red	red diffused	1.60 ... 20.00 4.00 ... 8.00 6.30 ... 12.50 10.00 ... 20.00 4.00 ... 32.00	Q62703-Q1989 Q62703-Q1414 Q62703-Q1990 Q62703-Q1991 Q62703-Q1992
LY 5480-HL LY 5480-J LY 5480-K LY 5480-L LY 5480-JM	yellow	yellow diffused	2.50 ... 20.00 4.00 ... 8.00 6.30 ... 12.50 10.00 ... 20.00 4.00 ... 32.00	Q62703-Q1416 Q62703-Q3236 Q62703-Q1418 Q62703-Q2402 Q62703-Q1419
LG 5480-GK LG 5480-H LG 5480-J LG 5480-K LG 5480-HL	green	green diffused	1.60 ... 12.50 2.50 ... 5.00 4.00 ... 8.00 6.30 ... 12.50 2.50 ... 20.00	Q62703-Q1423 Q62703-Q1422 Q62703-Q1869 Q62703-Q2018 Q62703-Q3191

Streuung der Lichtstärke in einer Verpackungseinheit  $I_{V_{\max}} / I_{V_{\min}} \leq 2.0$ .  
Luminous intensity ratio in one packaging unit  $I_{V_{\max}} / I_{V_{\min}} \leq 2.0$ .

**Grenzwerte**  
**Maximum Ratings**

Bezeichnung Parameter	Symbol Symbol	Werte Values		Einheit Unit
		LR	LS, LY, LG	
Betriebstemperatur Operating temperature range	$T_{op}$	- 55 ... + 100		°C
Lagertemperatur Storage temperature range	$T_{stg}$	- 55 ... + 100		°C
Sperrschichttemperatur Junction temperature	$T_j$	+ 100		°C
Durchlaßstrom Forward current	$I_F$	45	40	mA
Stoßstrom Surge current $t \leq 10 \mu s, D = 0.005$	$I_{FM}$	0.5		A
Sperrspannung Reverse voltage	$V_R$	5		V
Verlustleistung Power dissipation $T_A \leq 25 \text{ °C}$	$P_{tot}$	100	140	mW
Wärmewiderstand Thermal resistance Sperrschicht / Luft Junction / air	$R_{th JA}$	400		K/W

## Kennwerte ( $T_A = 25\text{ °C}$ ) Characteristics

Bezeichnung Parameter	Symbol Symbol	Werte Values				Einheit Unit
		LR	LS	LY	LG	
Wellenlänge des emittierten Lichtes Wavelength at peak emission $I_F = 20\text{ mA}$	(typ.) $\lambda_{\text{peak}}$ (typ.)	660	635	586	565	nm
Dominantwellenlänge Dominant wavelength $I_F = 20\text{ mA}$	(typ.) $\lambda_{\text{dom}}$ (typ.)	645	628	590	570	nm
Spektrale Bandbreite bei 50 % $I_{\text{rel max}}$ Spectral bandwidth at 50 % $I_{\text{rel max}}$ $I_F = 20\text{ mA}$	(typ.) $\Delta\lambda$ (typ.)	35	45	45	25	nm
Abstrahlwinkel bei 50 % $I_V$ (Vollwinkel) Viewing angle at 50 % $I_V$	$2\phi$	80	80	80	80	Grad deg.
Durchlaßspannung Forward voltage $I_F = 10\text{ mA}$	(typ.) $V_F$ (max.) $V_F$	1.6 2.0	2.0 2.6	2.0 2.6	2.0 2.6	V V
Sperrstrom Reverse current $V_R = 5\text{ V}$	(typ.) $I_R$ (max.) $I_R$	0.01 10	0.01 10	0.01 10	0.01 10	$\mu\text{A}$ $\mu\text{A}$
Kapazität Capacitance $V_R = 0\text{ V}, f = 1\text{ MHz}$	(typ.) $C_0$	25	12	10	15	pF
Schaltzeiten: Switching times: $I_V$ from 10 % to 90 % $I_V$ from 90 % to 10 % $I_F = 100\text{ mA}, t_p = 10\text{ }\mu\text{s}, R_L = 50\text{ }\Omega$	(typ.) $t_r$ (typ.) $t_f$	120 50	300 150	300 150	450 200	ns ns

**Relative spektrale Emission**  $I_{rel} = f(\lambda)$ ,  $T_A = 25\text{ }^\circ\text{C}$ ,  $I_F = 20\text{ mA}$

**Relative spectral emission**

$V(\lambda)$  = spektrale Augenempfindlichkeit  
Standard eye response curve

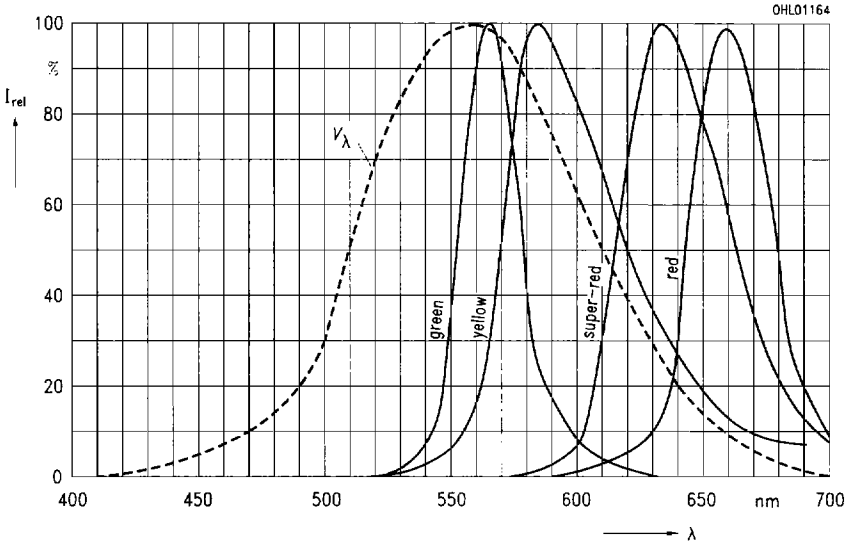

**Abstrahlcharakteristik**  $I_{rel} = f(\varphi)$

**Radiation characteristic**

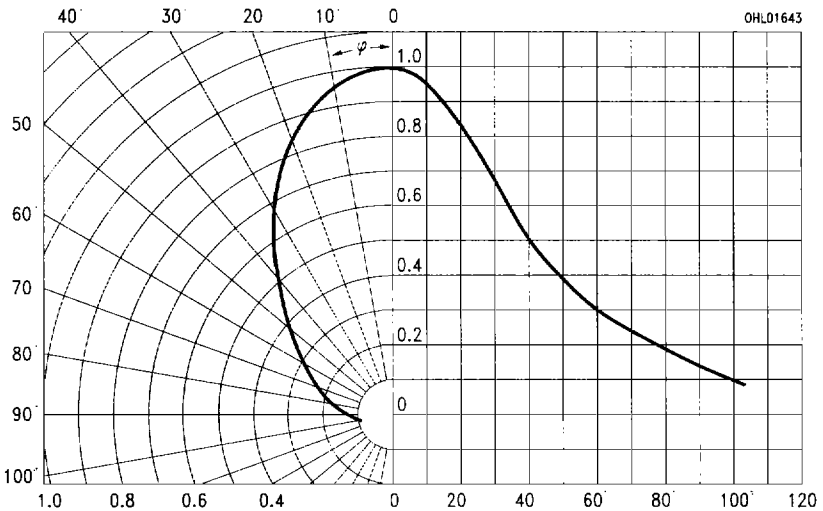

### Durchlaßstrom $I_F = f(V_F)$

#### Forward current

$T_A = 25^\circ\text{C}$

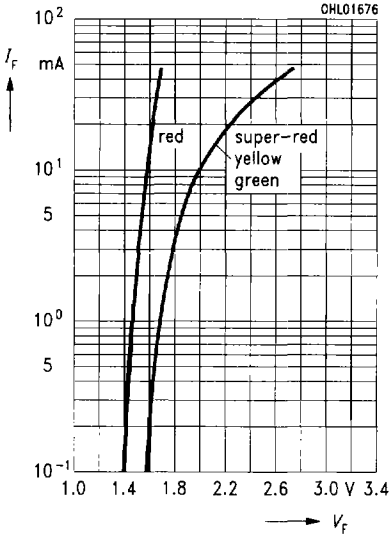

### Relative Lichtstärke $I_V/I_{V(10\text{mA})} = f(I_F)$

#### Relative luminous intensity

$T_A = 25^\circ\text{C}$

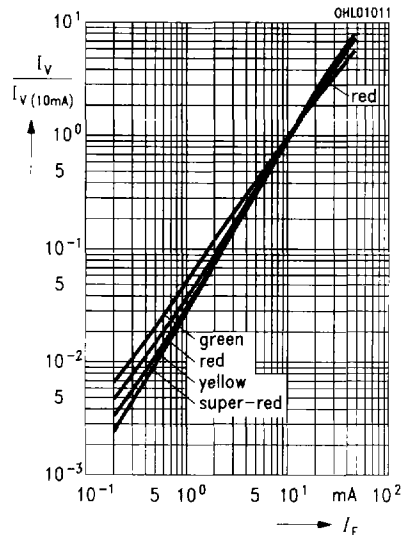

### Zulässige Impulsbelastbarkeit $I_F = f(t_p)$

#### Permissible pulse handling capability

Duty cycle  $D =$  parameter,  $T_A = 25^\circ\text{C}$

LS, LY, LG

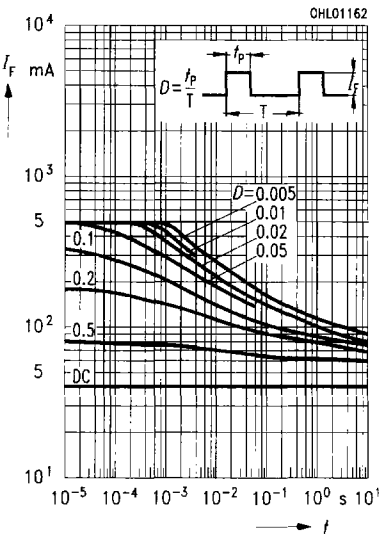

### Zulässige Impulsbelastbarkeit $I_F = f(t_p)$

#### Permissible pulse handling capability

Duty cycle  $D =$  parameter,  $T_A = 25^\circ\text{C}$

LR

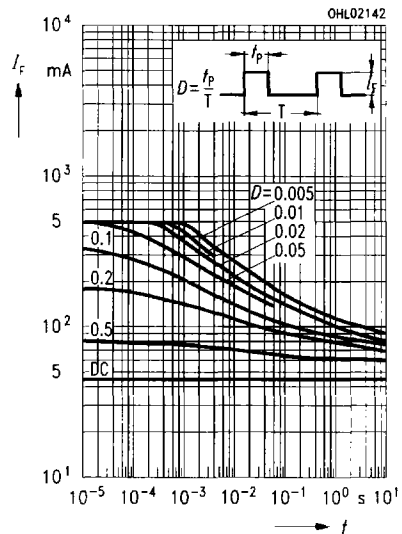

**Maximal zulässiger Durchlaßstrom**  
**Max. permissible forward current**

$I_F = f(T_A)$

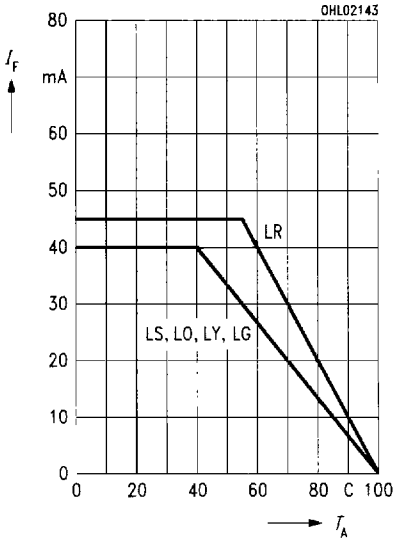

**Wellenlänge der Strahlung  $\lambda_{peak} = f(T_A)$**   
**Wavelength at peak emission**

$I_F = 20 \text{ mA}$

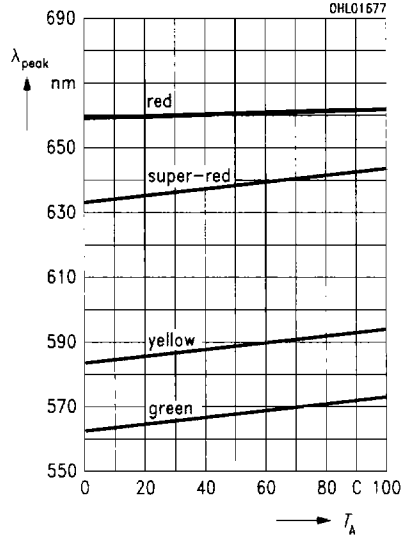

**Dominantwellenlänge  $\lambda_{dom} = f(T_A)$**   
**Dominant wavelength**

$I_F = 20 \text{ mA}$

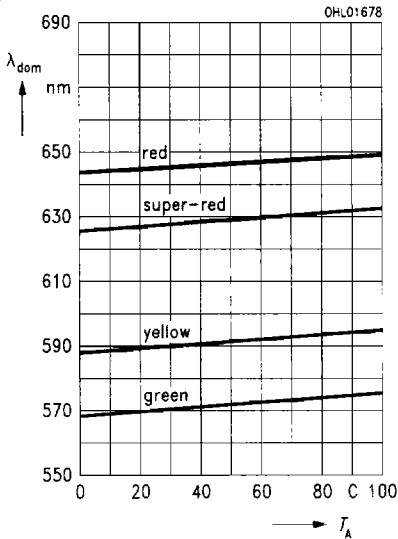

**Durchlaßspannung  $V_F = f(T_A)$**   
**Forward voltage**

$I_F = 10 \text{ mA}$

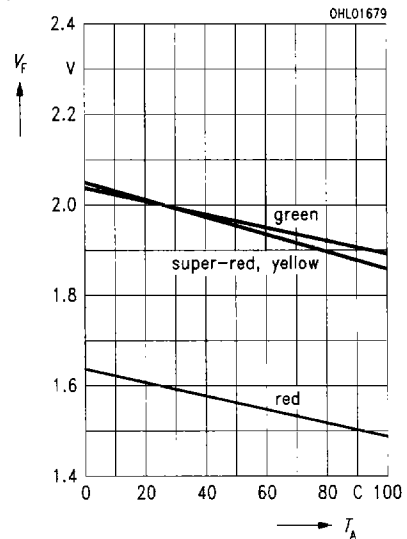

Relative Lichtstärke  $I_v/I_{v(25^\circ\text{C})} = f(T_A)$   
Relative luminous intensity

$I_F = 10 \text{ mA}$

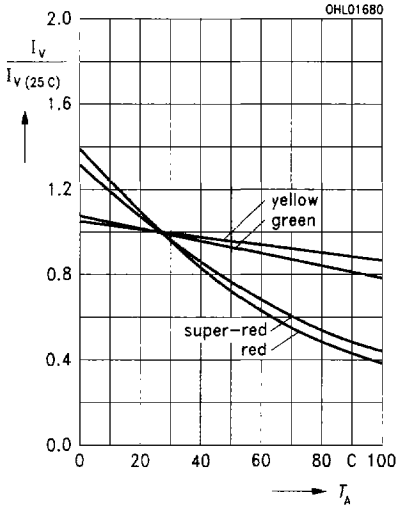

Maßzeichnung (Maße in mm, wenn nicht anders angegeben)  
Package Outlines (Dimensions in mm, unless otherwise specified)

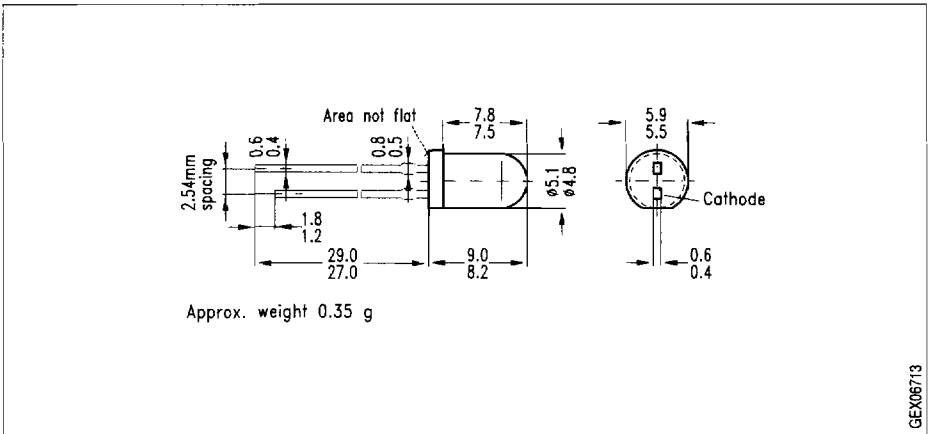

Kathodenkennzeichnung: Kürzerer Lötspieß  
Cathode mark: Short solder lead