

Factory Programmable Quad PLL Clock Generator with VCXO

Features

- Fully integrated phase-locked loops (PLLs)
- QFN package
- 40% smaller than 20-pin TSSOP
- 22% smaller than 16-pin TSSOP
- Selectable Output Frequency
- Programmable Output Frequencies
- Output Frequency Range of 5–166 MHz
- Input Frequency Range
- Crystal: 10–30 MHz
- External Reference: 1–100 MHz
- Analog VCXO

- 16-/20-pin TSSOP and 32-pin QFN packages
- 3.3V operation with 2.5V output buffer option

Benefits

- Meets most Digital Set Top Box, DVD Recorder, and DTV application requirements
- Multiple high-performance PLLs allow synthesis of unrelated frequencies
- Integration eliminates the need for external loop filter components
- Meets critical timing requirements in complex system designs
- Enables application compatibility
- Complete VCXO solution with ± 120 ppm (typical pull range)

Logic Block Diagram

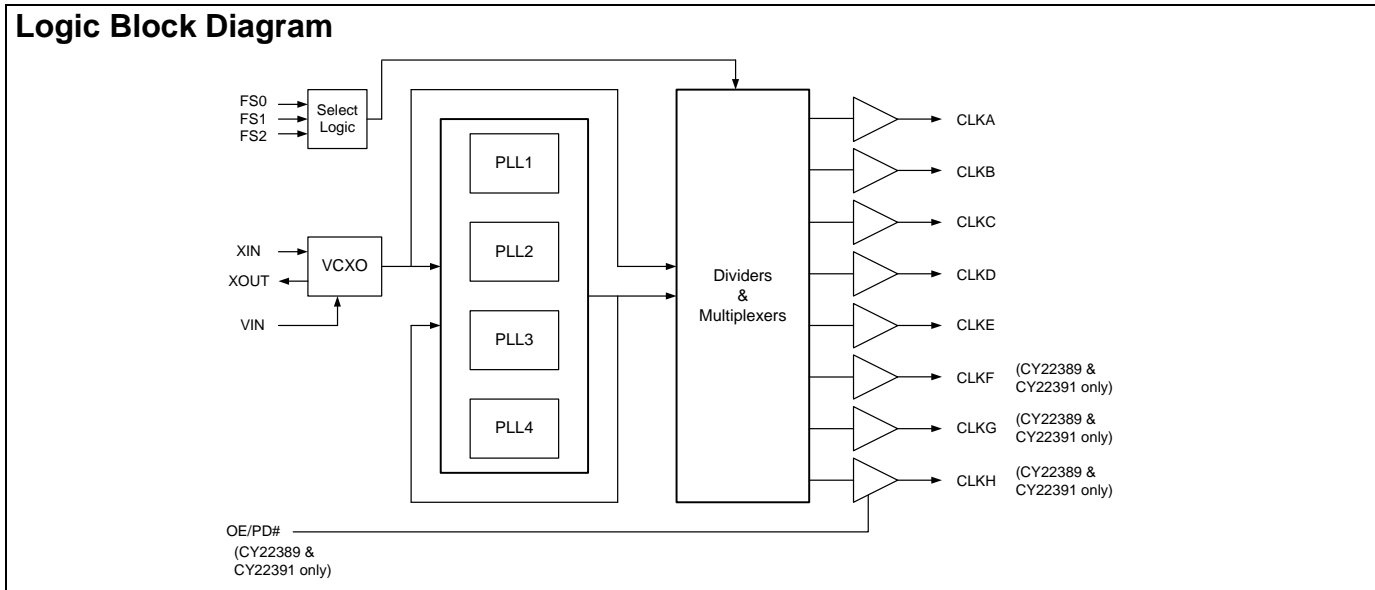

Pinouts

Figure 1. Pin Diagram - 16-Pin TSSOP CY22388

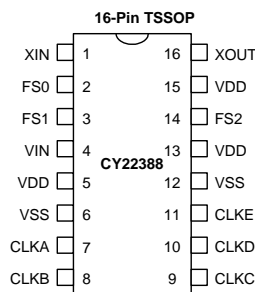

Figure 2. Pin Diagram - 20-Pin TSSOP CY22389

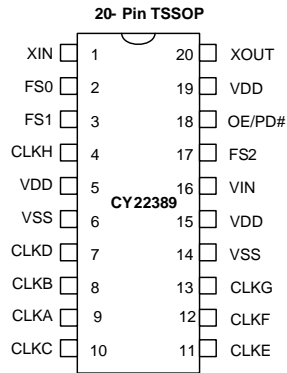
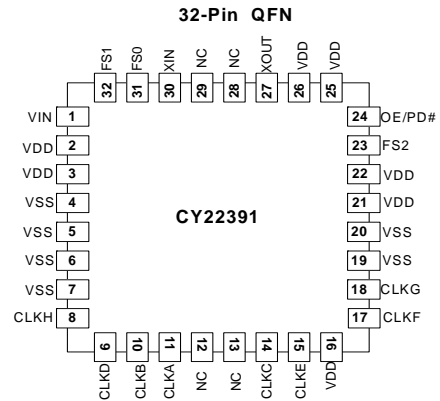

Figure 3. Pin Diagram - 32-Pin TSSOP CY22391



Pin Definitions

Pin Name	Pin Number			Pin Description
	16-Pin TSSOP	20-Pin TSSOP	32-Pin QFN	
XIN	1	1	30	Crystal Input or Reference Clock Input
XOUT	16	20	27	Crystal Output (No connect if external clock is used)
CLKA	7	9	11	Clock Output
CLKB	8	8	10	Clock Output
CLKC	9	10	14	Clock Output
CLKD	10	7	9	Clock Output
CLKE	11	11	15	Clock Output
CLKF	n/a	12	17	Clock Output
CLKG	n/a	13	18	Clock Output
CLKH	n/a	4	8	Clock Output
FS0	2	2	31	Frequency Select 0
FS1	3	3	32	Frequency Select 1
FS2	14	17	23	Frequency Select 2
OE/PD#	n/a	18	24	Programmable control pin: Output Enable (active-high) or Power Down (active-low)
VIN	4	16	1	Analog Control Input for VCXO
VDD	5,13,15	5,15,19	2,3,16,21,22,25,26	Voltage Supply
VSS	6,12	6,14	4,5,6,7,19,20	Ground
NC	n/a	n/a	12,13,28,29	No Connect.

General Description

The CY22388 family of devices has an Analog VCXO (Voltage Controlled Crystal Oscillator), 4 PLLs, up to 8 clock outputs and frequency selection capabilities. The frequency selects do not modify any PLL frequency. Instead they allow the user to choose between up to 8 different output divider selections depending on the clock and package configuration. This is illustrated in the following Frequency Selection tables and Functional Block Diagram.

There is one programmable OE/PD#. The OE/PD# pin can be programmed as either an output enable pin or a power down pin. The OE function can be programmed to disable a selected set of outputs when low, leaving the remaining outputs running. Full-chip power down disable all outputs and the PLLs and most of the active circuitry when low.

Factory-Programmable CY22388/89/91

Factory programming is available for high- or low-volume manufacturing by Cypress. All requests must be submitted to the local Cypress Field Application Engineer (FAE) or sales representative. Once the request has been processed, you will receive a new part number, samples, and data sheet with the programmed values. This part number is used for additional sample requests and production orders.

PLLs

The advantage of having four PLLs is that a single device can generate up to four independent frequencies from a single crystal. Generally a design may require up to four oscillators to accomplish what could be done with a single CY22388.

Each PLL is independent and can be configured to generate a VCO (Voltage Controlled Oscillator) frequency between 62.5 MHz and 250 MHz. Each PLL can then in turn be divided down with post dividers to generate the clock output frequency of the user's choice. The output divider allows each clock output to be divided by 1, 2, 3, 4, 5, 6, 8, 9, 10, 12 or 15. The PLL maximum is reduced to 166 MHz in divide by 1 mode due to output buffer limitations.

Outputs that allow frequency switching perform the transition free of glitches. A glitch is defined as a high or low time shorter than half the smaller of the two periods being switched between. Extended low time (even many cycles in duration) is acceptable.

Selected clock outputs are capable of being powered off a separate 2.5V supply. This allows for driving lower voltage swing inputs. The CY22388/89/91 device still requires 3.3V to power the oscillator and all other internal PLL circuitry. For the 2.5V output option please refer to the CY22388 Application Note. Selected clocks and pinout diagrams are explained in this application note.

Clock D can obtain its output from either the reference source or PLL1/N1 with N1 being defined as the output divider for PLL1. Clock H is defined as a copy of clock D. Clock D is only available from PLL1/N1 on the 16-pin package.

For CY22388, CLKB and CLKC have related frequencies. For CY22389 and CY22391, CLKD and CLKF have related frequencies, CLKA and CLKB have related frequencies, and CLKC and CLKE have related frequencies. Related frequencies come from the same PLL but can have different divider values.

In order to minimize PPM (Parts Per Million) error on the clock outputs, a user must choose a crystal reference frequency that is a common multiple of the desired PLL frequencies. While this would be the ideal situation, this is not always the case and the PLLs have high-resolution counters internally to help minimize frequency deviation from the desired frequency.

PLL VCO frequencies are generated by the following equation:
 $F_{VCO} = F_{REF} * (P / Q)$

Where F_{REF} is the reference input frequency, P is the PLL feedback divider and Q is the reference input divider.

A PLL is a feedback system where the VCO frequency divided by P and reference frequency divided by Q are constantly being compared and the VCO frequency is adjusted to achieve a locked state. Figure 3 is a simplified drawing of a PLL.

Figure 3. PLL system

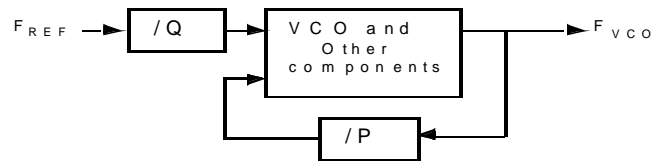

Frequency Select Pin Operation

Table 1. CY22388 16-pin TSSOP

Output Signal	Frequency Selection Lines
CLK A	FS2, FS1, FS0
CLK B	FS1, FS0
CLK C & CLK D	S0
CLK E	FIXED

Table 2. CY22389 20-pin TSSOP

Output Signal	Frequency Selection Lines
CLK A	FS2, FS1, FS0
CLK B & CLK C	FS1, FS0
CLK D, CLK E, & CLK F	FS0
CLK G	FIXED
CLK H	COPY OF CLK D

Table 3. CY22391 32-pin QFN

Output Signal	Frequency Selection Lines
CLK A	FS2, FS1, FS0
CLK B & CLK C	FS1, FS0
CLK D, CLK E, & CLK F	FS0
CLK G	FIXED
CLK H	COPY OF CLK D

Analog VCXO

There are three programmable reference operating modes for the CY22388, CY22389, CY22391 family of devices. The first mode utilizes an external pullable crystal and incorporates an internal Analog VCXO.

The second mode configures the internal crystal oscillator to accept an external driven reference source from 1 to 100 MHz. The input capacitance on the XIN PIN when driven in this mode is 15 pF.

The third mode disables the VCXO input control and sets the internal oscillator to a fixed frequency operation. The load capacitance seen by the external crystal when connected to PINS XIN and XOUT is equal to 12 pF.

One of the key components to the CY22388, CY22389, CY22391 family of devices is the analog VCXO. The VCXO is used to “pull” the reference crystal higher or lower in order to lock the system frequency to an external source. This is ideal for applications where the output frequency needs to track along with an external reference frequency that is constantly shifting.

The VCXO is completely analog, so there is infinite resolution on the VCXO pull curve. The Analog to Digital Converter steps that are normally associated with a digital VCXO input is not present in this device. A special pullable crystal must be used in order to have adequate VCXO pull range. Pullable Crystal specifications are included in this data sheet.

Please refer to the CY22388, CY22389, CY22391 Application Note for pullable crystal recommendations outside of the standard industry frequencies given in the Pullable Crystal Specifications.

VCXO Profile

Figure 4 shows an example of what a VCXO profile looks like. The analog voltage input is on the X-axis and the PPM range is on the Y-axis. An increase in the VCXO input voltage results in a corresponding increase in the output frequency. This has the effect of moving the PPM from a negative to positive offset.

Figure 4. VCXO Profile

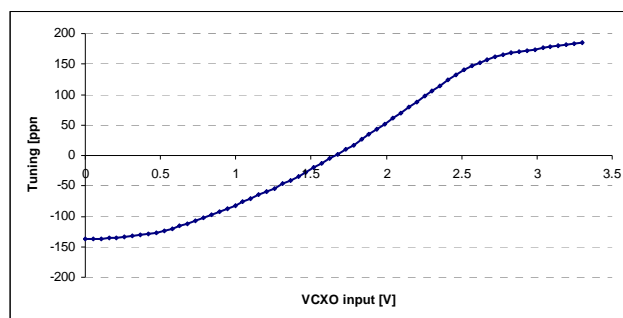

Absolute Maximum Conditions

Parameter	Description	Condition	Min	Max	Unit
V _{DD} /AV _{DD} /V _{DDL}	Core Supply Voltage		-0.5	4.6	V
V _{IN}	Input Voltage	Relative to V _{SS}	-0.5	V _{DD} + 0.5	VDC
T _S	Temperature, Storage	Non-Functional	-65	+125	°C
ESD _{HBM}	ESD Protection (Human Body Model)	MIL-STD-883, Method 3015	2000	-	Volts
UL-94	Flammability Rating	V-0 at 1/8 in.	-	10	ppm
MSL	Moisture Sensitivity Level	QFN package	3		
		16- and 20-pin TSSOP	1		

Pullable Crystal Specifications^[1, 3]

Parameter	Description	Comments	Min	Typ.	Max	Unit
F _{NOM}	13.5 MHz and 27 MHz Crystal AT-Cut	Parallel resonance, Fundamental mode	See Note 3			
C _{LNOM}	Nominal Load Capacitance	Order crystal at one specific C _{LNOM} 0 ppm	11.4	12	12.6	pF
R ₁	Equivalent Series Resistance (ESR)	Fundamental mode (CL = Series)	-	-	40	Ω
DL	Crystal Drive Level	Nominal VDD at 25C over ±120 PPM Pull Range	-	-	300	μW
C ₀ ^[2]	Crystal Shunt Capacitance		1.5	3	4.0	pF

Notes

1. Device operates to the following specs, which are guaranteed by design.
2. Increased tolerance available from pull range less than ±120PPM.
3. Refer to CY22388 Application Note and online software for a list of Approved Crystal Specifications.

Pullable Crystal Specifications^[1, 3]

Parameter	Description	Comments	Min	Typ.	Max	Unit
C_1 ^[2]	Crystal Motional Capacitance		12	14	16.8	fF
F_{3SEPHI} ^[3]	Third Overtone Separation from $3 \cdot F_{NOM}$	Mechanical Third (High side of $3 \cdot F_{NOM}$)	240	–	–	ppm
F_{3SEPLO} ^[3]	Third Overtone Separation from $3 \cdot F_{NOM}$	Mechanical Third (Low side of $3 \cdot F_{NOM}$)	–	–	–120	ppm

Recommended Operating Conditions

Parameter	Description	Min	Typ.	Max	Unit
$V_{DD}/AV_{DD}/V_{DDL}$	Operating Voltage	3.0	3.3	3.6	V
T_A	Ambient Temperature	–10	–	70	°C
C_{LOAD}	Maximum Load Capacitance	–	–	15	pF
t_{PU}	Power up time for all V_{DD} s reach minimum specified voltage (power ramps must be monotonic)	0.05	–	500	ms

DC Parameters^[4]

Parameter	Description	Conditions	Min	Typ.	Max	Unit
I_{OH} ^[5]	Output High Current	$V_{OH} = V_{DD} - 0.5$, $V_{DD} = 3.3V$	12	–	–	mA
I_{OL} ^[5]	Output Low Current	$V_{OL} = 0.5$, $V_{DD} = 3.3V$	12	–	–	mA
I_{IH}	Input High Current	$V_{IH} = V_{DD}$, excluding Vin, Xin	–	5	10	μA
I_{IL}	Input Low Current	$V_{IL} = 0V$, excluding Vin, Xin	–	5	10	μA
V_{IH}	Input High Voltage	FS0/1/2 OE input CMOS levels	$0.7 \times A_{VDD}$	–	–	V
V_{IL}	Input Low Voltage	FS0/1/2 OE input CMOS levels	–	–	$0.3 \times A_{VDD}$	V
Parameter	Description	Conditions	Min	Typ.	Max	Unit
V_{VCXO}	VIN Input Range		0	–	A_{VDD}	V
C_{IN}	Input Capacitance	FS0/1/2 and OE Pins only	–	–	7	pF
I_{VDD}	Supply Current	$V_{DD}/AV_{DD}/V_{DDL}$ Current	–	60	–	mA
C_{INXIN}	Input Capacitance at XIN	VCXO Disabled External Reference	–	15	–	pF
C_{INXTAL}	Input Capacitance at Crystal	VCXO Disabled Fixed Freq. Oscillator	–	12	–	pF

AC Parameters

Parameter ^[4]	Description	Conditions	Min	Typ.	Max	Units
1/t1	Output Frequency	PLL _{minmax} /Divider _{maximum}	4.2	–	166	MHz
DC1	Output Duty Cycle (excluding REFOUT)	Duty Cycle is defined in Figure 6; t_2/t_1 , 50% of V_{DD} External reference duty cycle between 40% and 60% measured at $V_{DD}/2$ (Clock output is ≤ 125 MHz)	45	50	55	%
DC2	Output Duty Cycle	Duty Cycle is defined in Figure 6; t_2/t_1 , 50% of V_{DD} External reference duty cycle between 40% and 60% measured at $V_{DD}/2$ (Clock output is > 125 MHz)	40	50	60	%
DC _{REFOUT}	Output Duty Cycle	Duty Cycle is defined in Figure 6; t_2/t_1 , 50% of V_{DD} (XIN Duty Cycle = 45/55%)	40	50	60	%

Notes

- Parameters are guaranteed by design and characterization. Not 100% tested in production. All parameters specified with fully loaded outputs.
- Custom Drive level and is available upon request

AC Parameters (continued)

Parameter ^[4]	Description	Conditions	Min	Typ.	Max	Units
ER	Rising Edge Rate	Output Clock Edge Rate. Measured from 20% to 80% of V_{DD} . $C_{LOAD} = 15$ pF. See Figure 7.	0.75	1.2	–	V/ns
EF	Falling Edge Rate	Output Clock Edge Rate. Measured from 80% to 20% of V_{DD} . $C_{LOAD} = 15$ pF. See Figure 7.	0.75	1.2	–	V/ns
T_9	Clock Jitter	Period Jitter	–	±250	–	ps
T_{10}	PLL Lock Time		–	1	5	ms
$f_{\Delta XO}$	VCXO Crystal Pull Range	Using non-SMD-49 crystal specified in “CY22388 Application Note, ANC0002” Nominal Crystal Frequency Input assumed (0 ppm) at 25°C and 3.3V	±110	±120	–	ppm
		Using SMD-49 crystal specified in “CY22388 Application Note, ANC0002” Nominal Crystal Frequency Input assumed (0 ppm) at 25°C and 3.3V	±105	±120	–	ppm

Figure 5. Test and Measurement

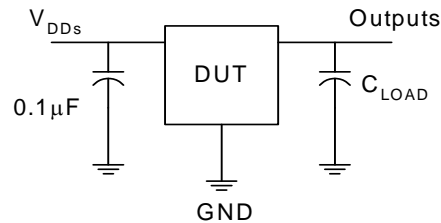

Voltage and Timing Definitions

Figure 6. Duty Cycle Definition

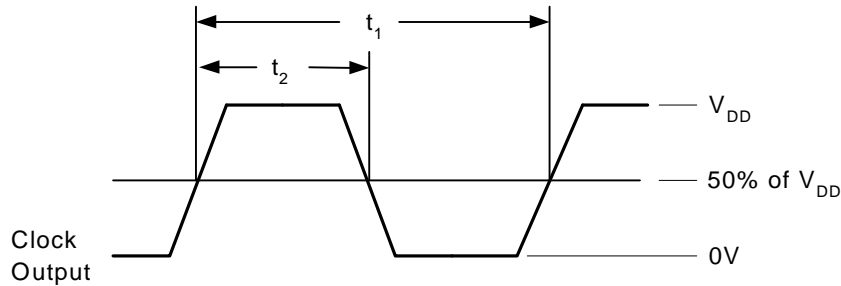
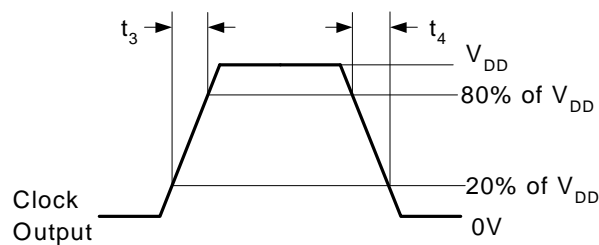
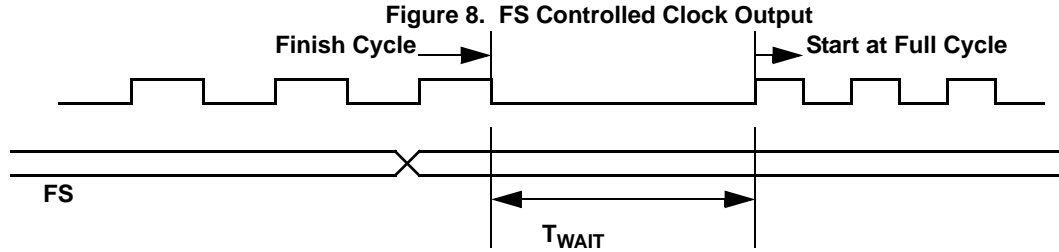

Figure 7. $ER = (0.6 \times V_{DD})/t_3$, $EF = (0.6 \times V_{DD})/t_4$





Ordering Information

Part Number ^[6]	Package	Type	Production Flow
Pb-free			
CY22388ZXC-xxx	ZZ16	16-pin TSSOP	Commercial, 0°C to +70°C
CY22388ZXC-xxxT	ZZ16	16-pin TSSOP - Tape and Reel	Commercial, 0°C to +70°C
CY22389ZXC-xxx	ZZ20	20-pin TSSOP	Commercial, 0°C to +70°C
CY22389ZXC-xxxT	ZZ20	20-pin TSSOP - Tape and Reel	Commercial, 0°C to +70°C
CY22391LFXC-xxx ^[7]	LY32	32-pin QFN (Punch)	Commercial, 0°C to +70°C
CY22391LFXC-xxxT ^[7]	LY32	32-pin QFN (Punch) - Tape and Reel	Commercial, 0°C to +70°C
CY22391LTXC-xxx	LT32	32-pin QFN (Saw)	Commercial, 0°C to +70°C
CY22391LTXC-xxxT	LT32	32-pin QFN (Saw) - Tape and Reel	Commercial, 0°C to +70°C

Package Drawing and Dimensions

Figure 9. 16-Pin TSSOP 4.40 mm Body ZZ16

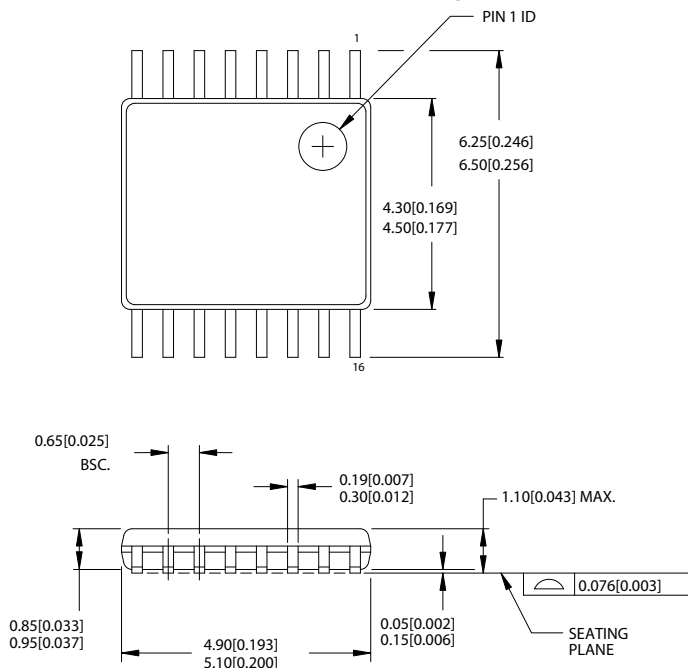

DIMENSIONS IN MM[INCHES] MIN. MAX.

REFERENCE JEDEC MO-153

PACKAGE WEIGHT 0.05 gms

PART #	
Z16.173	STANDARD PKG.
ZZ16.173	LEAD FREE PKG.

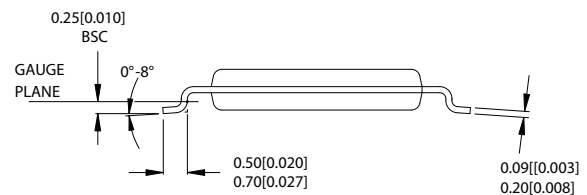

51-85091-*A

Note

- 6. The CY22388ZXC-xxx, CY22389ZXC-xxx, and CY22391LFXC-xxx are factory programmed configurations. For more details, contact your local Cypress FAE or Cypress Sales Representative.
- 7. Not recommended for new designs. The LY32 QFN package transitions to the LT32 QFN.

Figure 10. 20-Pin Thin Shrunk Small Outline Package (4.40-mm Body) ZZ20

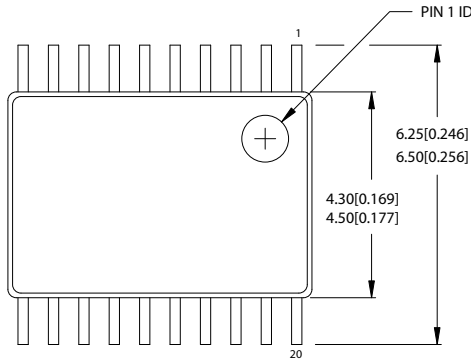

DIMENSIONS IN MM[INCHES] MIN.

MAX.

REFERENCE JEDEC MO-153

PART #
Z20.173 STANDARD PKG.
ZZ20.173 LEAD FREE PKG.

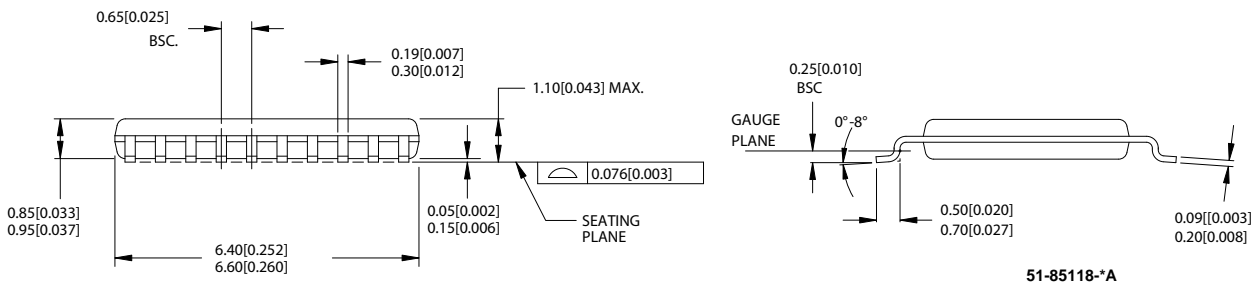

51-85118-*A

Figure 11. 32-Pin Punch QFN (5 x 5 mm) LY32

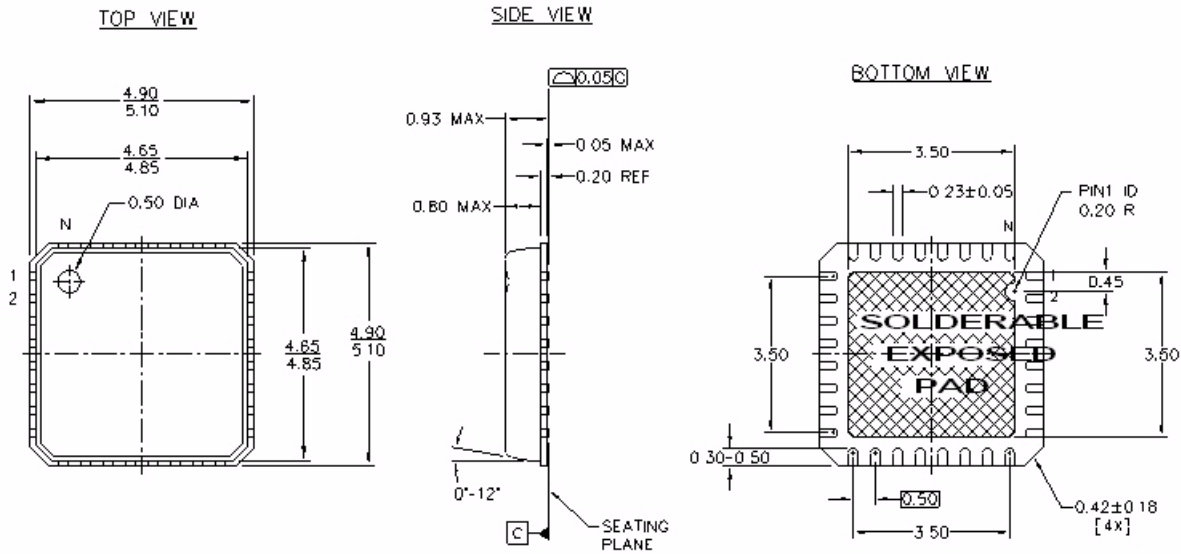

NOTES:

-  HATCH AREA IS SOLDERABLE EXPOSED PAD.
- REFERENCE JEDEC#: MO-220
- PACKAGE WEIGHT: 0.054g
- ALL DIMENSIONS ARE IN MM [MIN/MAX]
- PACKAGE CODE

PART #	DESCRIPTION
LF32	STANDARD
LY32	PB-FREE

51-85188-*B

Figure 12. 32-Pin Sawn QFN (5 x 5 mm) LT32

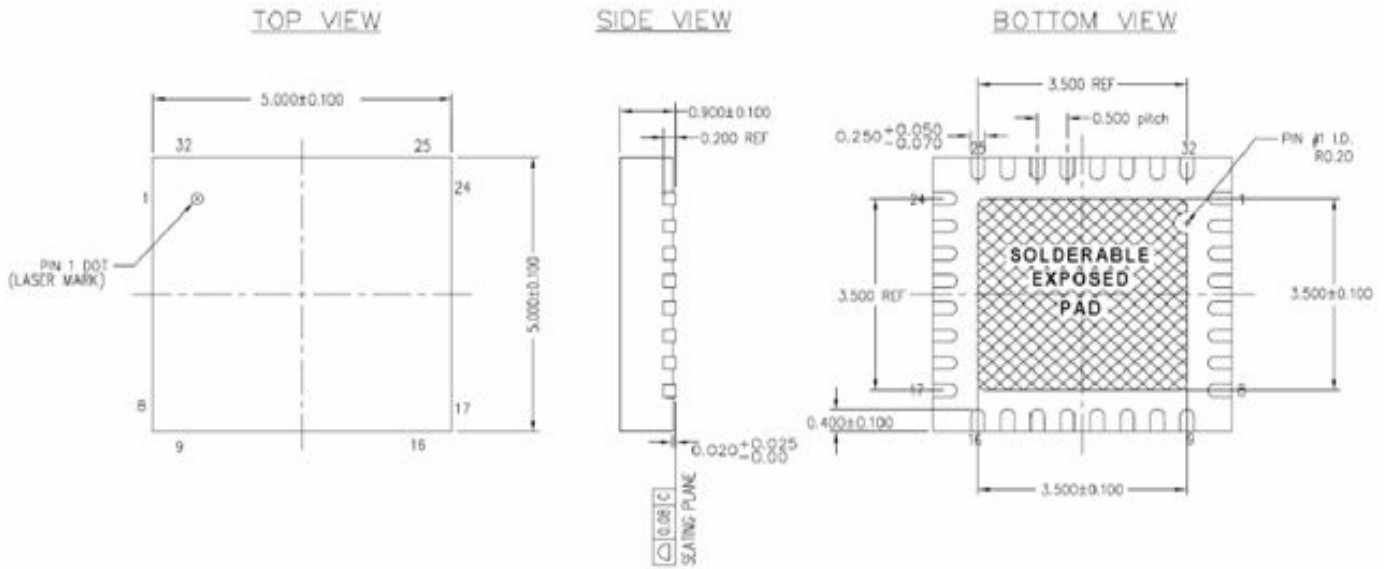

NOTES:

1.  HATCH AREA IS SOLDERABLE EXPOSED PAD
2. BASED ON REF JEDEC # MO-220
3. PACKAGE WEIGHT: 0.058g
4. DIMENSIONS ARE IN MILLIMETERS

001-30999 *A

Document History Page

Document Title: CY22388, CY22389, CY22391 Factory Programmable Quad PLL Clock Generator with VCXO Document Number: 38-07734				
REV.	ECN	Orig. of Change	Submission Date	Description of Change
**	320458	RGL	03/07/05	New data sheet Internal setting in VCXO are:XOB/A=110, Offset=1110, Gain=101
*A	389649	RGL	08/02/05	Changed R1 value to max. 40Ω Changed DL comments and max. value to 300μW Changed f _{ΔXO} min. value to ±110ppm and typ. value to ±120ppm
*B	523597	RGL	11/12/06	Specified a non-SMD-49 and SMD-49 crystal specs in the VCXO Pull Range Parameter
*C	2632357	KVM	01/13/09	Updated template. Updated Ordering Information table to add tape & reel part numbers. Added LT32 (saw) QFN package for CY22391, including package drawing. LY32 (punch) QFN package "not recommended for new designs" Added Package column to Ordering Information table and cleaned up package references in captions of the package drawings. Changed document title to spell out each part number in full. Clarified that Power Down (PD#) is active-low: in block diagram, CY22389 pinout and in pin description table. Replaced PDWN and PD with PD#. Changed package diagram 51-85188*A to 51-85188*B.

Sales, Solutions, and Legal Information

Worldwide Sales and Design Support

Cypress maintains a worldwide network of offices, solution centers, manufacturer's representatives, and distributors. To find the office closest to you, visit us at cypress.com/sales.

Products

PSoC	psoc.cypress.com
Clocks & Buffers	clocks.cypress.com
Wireless	wireless.cypress.com
Memories	memory.cypress.com
Image Sensors	image.cypress.com

PSoC Solutions

General	psoc.cypress.com/solutions
Low Power/Low Voltage	psoc.cypress.com/low-power
Precision Analog	psoc.cypress.com/precision-analog
LCD Drive	psoc.cypress.com/lcd-drive
CAN 2.0b	psoc.cypress.com/can
USB	psoc.cypress.com/usb

© Cypress Semiconductor Corporation, 2005-2009. The information contained herein is subject to change without notice. Cypress Semiconductor Corporation assumes no responsibility for the use of any circuitry other than circuitry embodied in a Cypress product. Nor does it convey or imply any license under patent or other rights. Cypress products are not warranted nor intended to be used for medical, life support, life saving, critical control or safety applications, unless pursuant to an express written agreement with Cypress. Furthermore, Cypress does not authorize its products for use as critical components in life-support systems where a malfunction or failure may reasonably be expected to result in significant injury to the user. The inclusion of Cypress products in life-support systems application implies that the manufacturer assumes all risk of such use and in doing so indemnifies Cypress against all charges.

Any Source Code (software and/or firmware) is owned by Cypress Semiconductor Corporation (Cypress) and is protected by and subject to worldwide patent protection (United States and foreign), United States copyright laws and international treaty provisions. Cypress hereby grants to licensee a personal, non-exclusive, non-transferable license to copy, use, modify, create derivative works of, and compile the Cypress Source Code and derivative works for the sole purpose of creating custom software and or firmware in support of licensee product to be used only in conjunction with a Cypress integrated circuit as specified in the applicable agreement. Any reproduction, modification, translation, compilation, or representation of this Source Code except as specified above is prohibited without the express written permission of Cypress.

Disclaimer: CYPRESS MAKES NO WARRANTY OF ANY KIND, EXPRESS OR IMPLIED, WITH REGARD TO THIS MATERIAL, INCLUDING, BUT NOT LIMITED TO, THE IMPLIED WARRANTIES OF MERCHANTABILITY AND FITNESS FOR A PARTICULAR PURPOSE. Cypress reserves the right to make changes without further notice to the materials described herein. Cypress does not assume any liability arising out of the application or use of any product or circuit described herein. Cypress does not authorize its products for use as critical components in life-support systems where a malfunction or failure may reasonably be expected to result in significant injury to the user. The inclusion of Cypress' product in a life-support systems application implies that the manufacturer assumes all risk of such use and in doing so indemnifies Cypress against all charges.

Use may be limited by and subject to the applicable Cypress software license agreement.