

NJM4250

The NJM4250 is extremely versatile programmable monolithic operational amplifiers. A single external master bias current setting resistor programs the input bias current, input offset current, quiescent power consumption, slew rate, input noise, and the gain-bandwidth product. The device is a truly general purpose operational amplifier.

■ Package Outline

■ Absolute Maximum Ratings (Ta=25°C)

Supply Voltage	V ⁺ /V ⁻	±18V
Differential Input Voltage	V _{ID}	±30V
Input Voltage(note)	V _{IC}	±15V
Power Dissipation	P _D (D-Type)	500mW
	(M-Type)	300mW
	(V-Type)	250mW
Set Current	I _{SET}	150μA
Operating Temperature Range	T _{opr}	-20~+75°C
Storage Temperature Range	T _{stg}	-40~+125°C

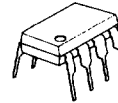

NJM4250D



NJM4250M
NJM4250E



NJM4250V

(note) For supply voltage less than ±15V, the absolute maximum input voltage is equal to the supply voltage.

■ Electrical Characteristics (Ta=25°C, V⁺/V⁻ = ±15V)

Parameter	Symbol	Test Condition	I _{SET} =1μA		I _{SET} =10μA		Unit
			Min.	Max.	Min.	Max.	
Input Offset Voltage 1	V _{IO 1}	R _S ≤ 100kΩ	—	5	—	6	mV
Input Offset Voltage 2	V _{IO 2}	V ⁺ /V ⁻ = ±1.5V, R _S ≤ 100kΩ	—	5	—	6	mV
Input Offset Current	I _{IO}		—	6	—	20	nA
Input Bias Current 1	I _{B 1}		—	10	—	75	nA
Input Bias Current 2	I _{B 2}	V ⁺ /V ⁻ = ±1.5V	—	10	—	75	nA
Large Signal Voltage Gain 1	A _{V 1}	V _o = ±10V, R _L ≥ 100kΩ	96	—	—	—	dB
Large Signal Voltage Gain 2	A _{V 2}	V _o = ±10V, R _L ≥ 10kΩ	—	—	96	—	dB
Supply Current 1	I _{CC 1}		—	11	—	100	μA
Supply Current 2	I _{CC 2}	V ⁺ /V ⁻ = ±1.5V	—	8	—	90	μA
Input Common Mode Voltage Range 1	V _{ICM 1}		±13.5	—	±13.5	—	V
Input Common Mode Voltage Range 2	V _{ICM 2}	V ⁺ /V ⁻ = ±1.5V	±0.6	—	±0.6	—	V
Maximum Output Voltage Swing 1	V _{OM 1}	R _L ≥ 100kΩ	±12	—	—	—	V
Maximum Output Voltage Swing 2	V _{OM 2}	V ⁺ /V ⁻ = ±1.5V, R _L ≥ 100kΩ	±0.6	—	—	—	V
Maximum Output Voltage Swing 3	V _{OM 3}	R _L ≥ 10kΩ	—	—	±12	—	V
Maximum Output Voltage Swing 4	V _{OM 4}	V ⁺ /V ⁻ = ±1.5V, R _L ≥ 10kΩ	—	—	±0.6	—	V
Common Mode Rejection Ratio	CMR	R _S ≤ 10kΩ	70	—	70	—	dB
Supply Voltage Rejection Ratio	SVR	R _S ≤ 10kΩ	74	—	74	—	dB

■ Equivalent Circuit

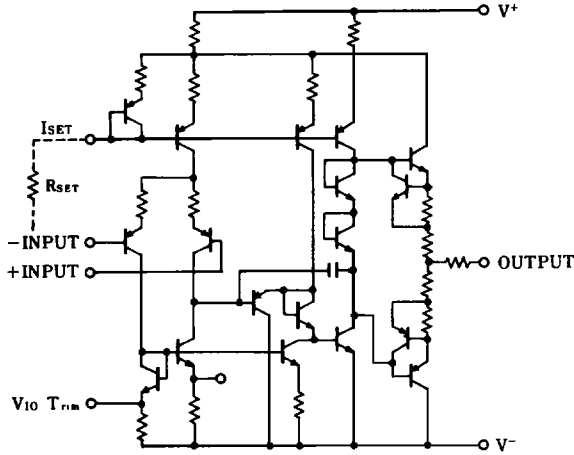

■ Connection Diagram

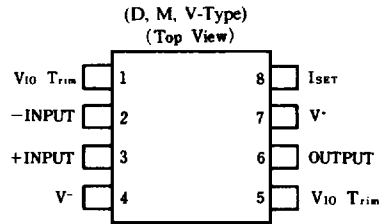

■ Typical Applications (I_{SET}, V₁₀ Adjustment)

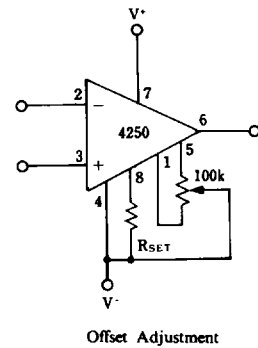
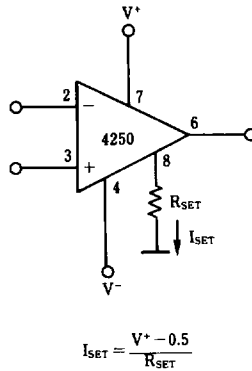
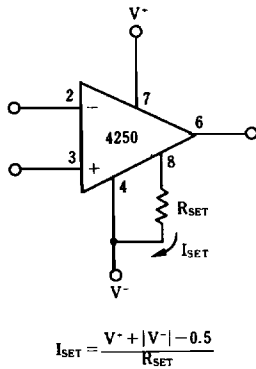

■ Typical Characteristics

Input Bias Current vs. Set Current
(T_a = 25°C)

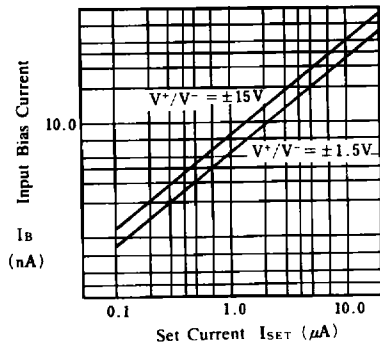

Input Bias Current vs. Temperature

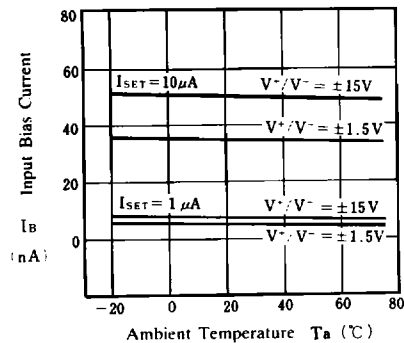

■ Typical Characteristics

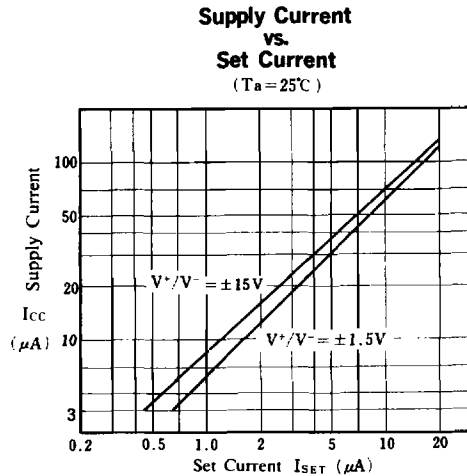
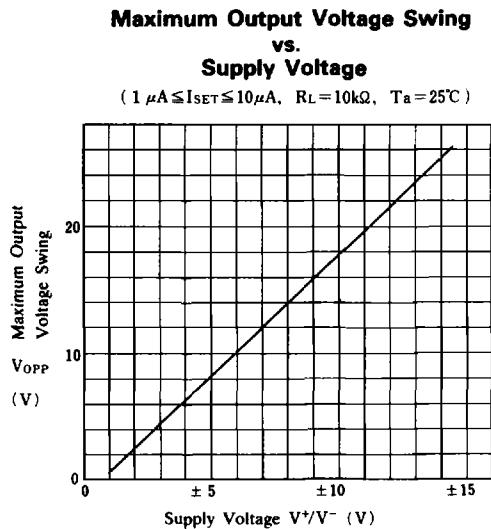
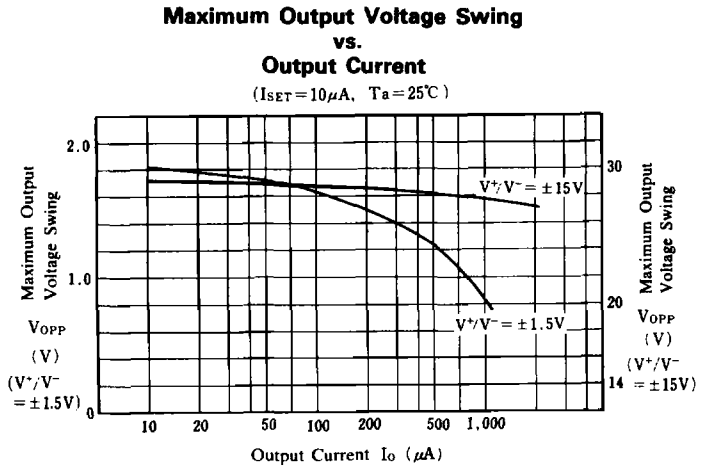
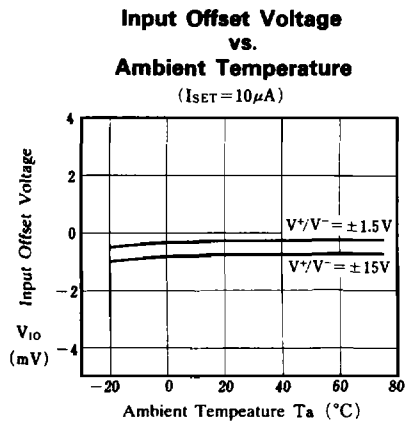
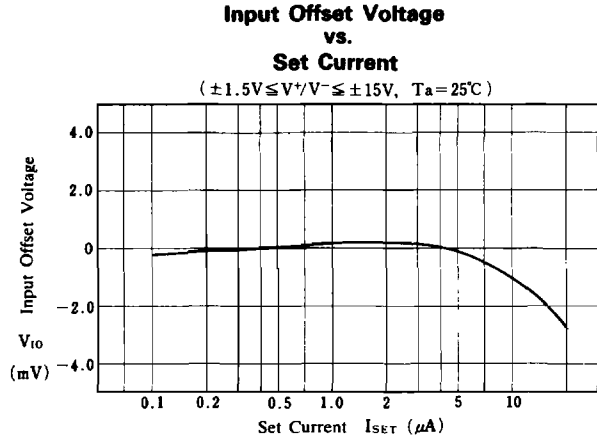
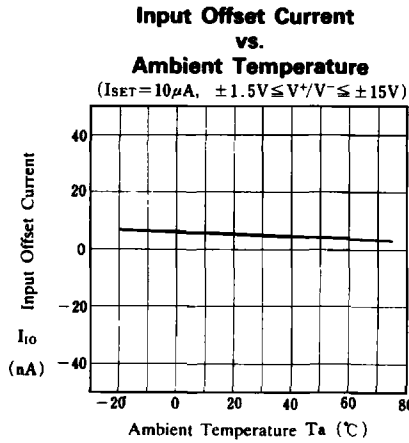

■ Typical Characteristics

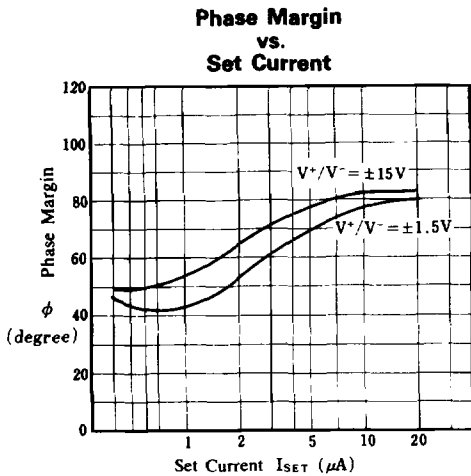
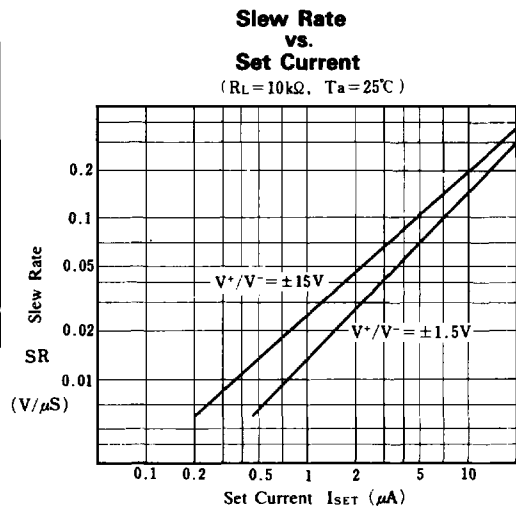
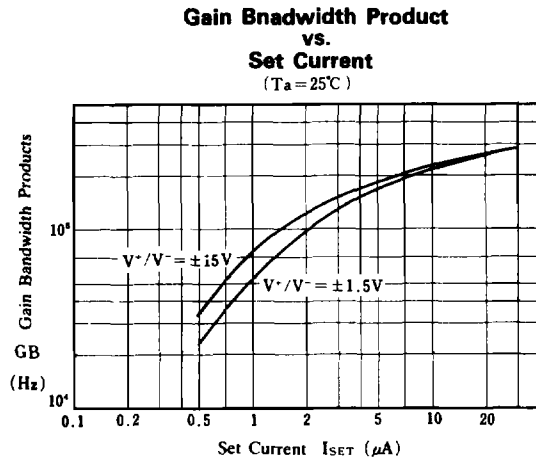
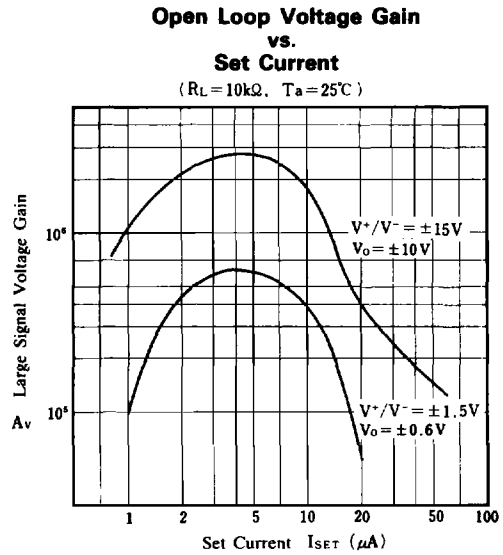
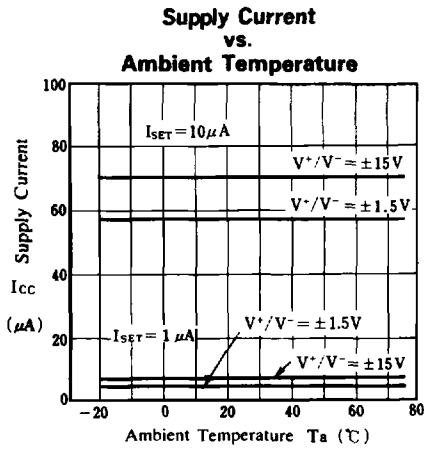

■ Typical Applications

500nW 10times Inverting Amplifier

