

MINI-DIN CONNECTORS

MMDS Series

Circular, Shielded
and Fully Shielded with Switch

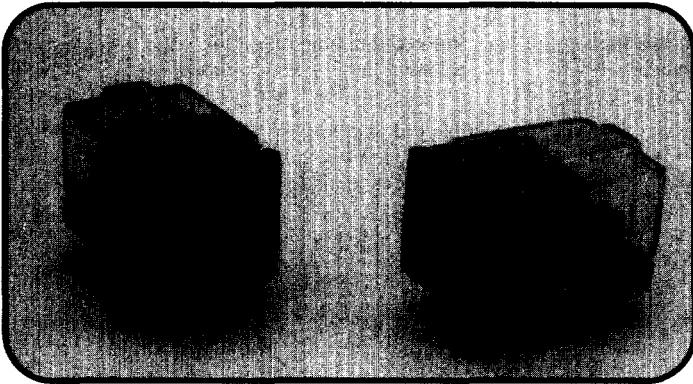

MAXCONN

Performance Specifications

Same as MMDF Series

DIMENSIONS

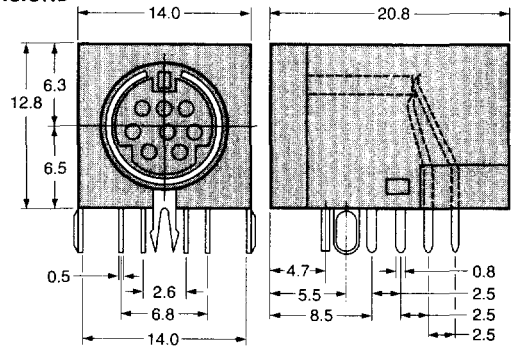

Arrangement
of Contacts

Number
of Contacts

PCB
Layout

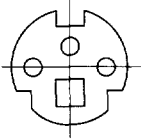

3

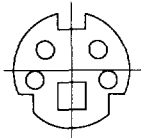
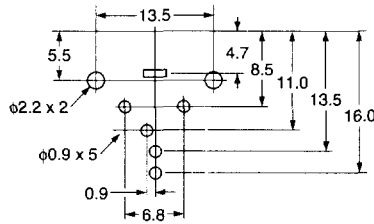

4

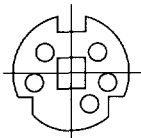
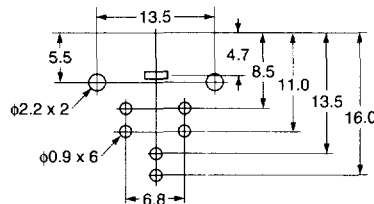

5

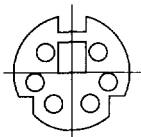
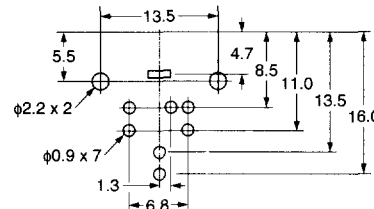

6

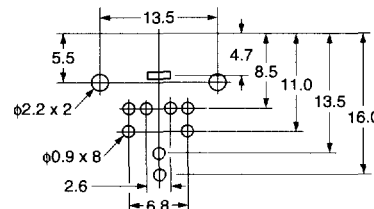

Arrangement
of Contacts

Number
of Contacts

PCB
Layout

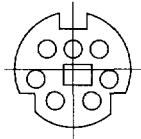

7

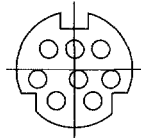
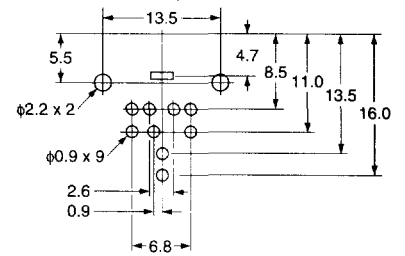

8

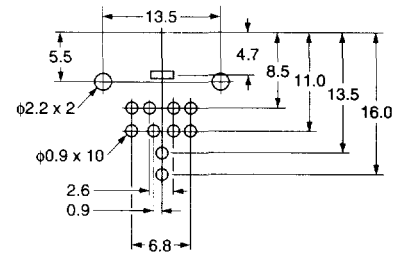

HOW TO ORDER

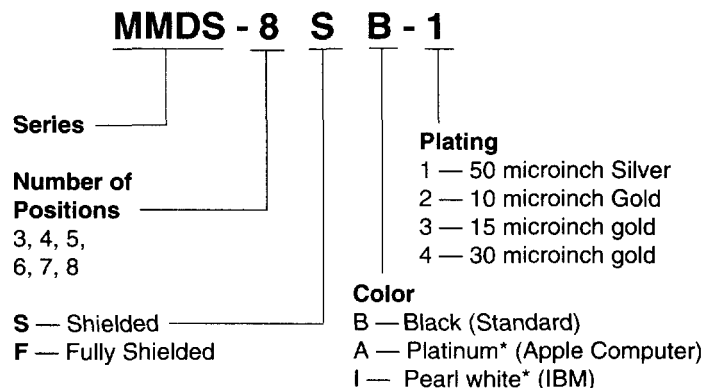

* 5,000 piece minimum order

** 9 position not available