

Subminiature LED Lamps

Technical Data

HLMP-Pxxx Series
HLMP-Qxxx Series
HLMP-6xxx Series
HLMP-70xx Series

Features

- **Subminiature Flat Top Package**
Ideal for Backlighting and Light Piping Applications
- **Subminiature Dome Package**
Diffused Dome for Wide Viewing Angle
Nondiffused Dome for High Brightness
- **TTL and LSTTL Compatible 5 Volt Resistor Lamps**
- **Available in Six Colors**
- **Ideal for Space Limited Applications**
- **Axial Leads**
- **Available with Lead Configurations for Surface Mount and Through Hole PC Board Mounting**

Description

Flat Top Package

The HLMP-Pxxx Series flat top lamps use an untinted, non-diffused, truncated lens to provide a wide radiation pattern that is necessary for use in backlighting applications. The flat top lamps are also ideal for use as emitters in light pipe applications.

Dome Packages

The HLMP-6xxx Series dome lamps for use as indicators use a tinted, diffused lens to provide a wide viewing angle with a high on-off contrast ratio. High brightness lamps use an untinted, nondiffused lens to provide a high luminous intensity within a narrow radiation pattern.

Resistor Lamps

The HLMP-6xxx Series 5 volt subminiature lamps with built in current limiting resistors are for use in applications where space is at a premium.

Lead Configurations

All of these devices are made by encapsulating LED chips on axial lead frames to form molded epoxy subminiature lamp packages. A variety of package configuration options is available. These



include special surface mount lead configurations, gull wing, yoke lead or Z-bend. Right angle lead bends at 2.54 mm (0.100 inch) and 5.08 mm (0.200 inch) center spacing are available for through hole mounting. For more information refer to Standard SMT and Through Hole Lead Bend Options for Subminiature LED Lamps data sheet.

Device Selection Guide

Part Number: HLMP-xxxx

Standard Red	DHAS AlGaAs Red	High Efficiency Red	Orange	Yellow	High Perf. Green	Emerald Green	Device Description ^[1]	Device Outline Drawing
	P105	P205	P405	P305	P505	P605	Untinted, Nondiffused, Flat Top	A
	P102	P202	P402	P302	P502		Untinted, Diffused, Flat Top	B
6000/6001	Q101	6300	Q400	6400	6500	Q600	Tinted, Diffused	
	Q105	6305		6405	6505		Untinted, Nondiffused, High Brightness	
	Q150	7000		7019	7040		Tinted, Diffused, Low Current	B
	Q155						Nondiffused, Low Current	
		6600		6700	6800		Tinted, Diffused, Resistor, 5 V, 10 mA	
		6620		6720	6820		Diffused, Resistor, 5 V, 4 mA	

Package Dimensions

(A) Flat Top Lamps

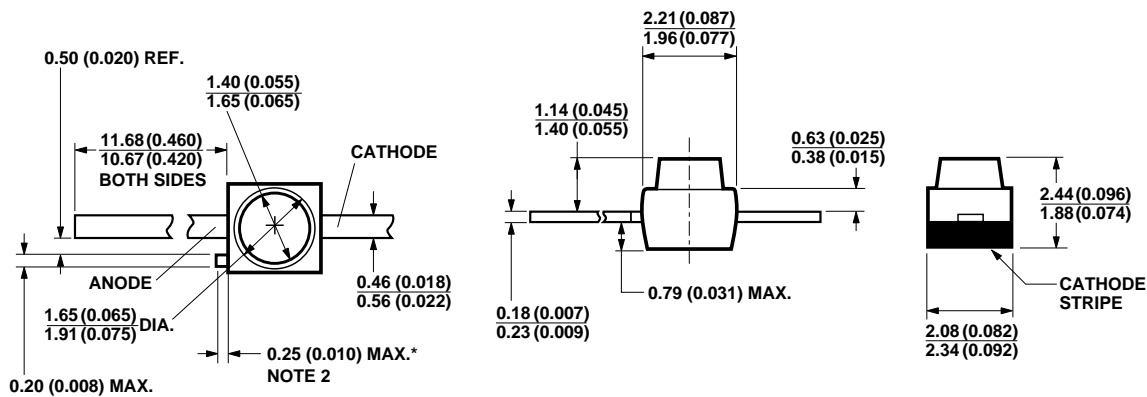

NOTES:

1. ALL DIMENSIONS ARE IN MILLIMETRES (INCHES).
2. PROTRUDING SUPPORT TAB IS CONNECTED TO CATHODE LEAD.

* REFER TO FIGURE 1 FOR DESIGN CONCERNS.

Package Dimensions (cont.)

(B) Diffused and Nondiffused

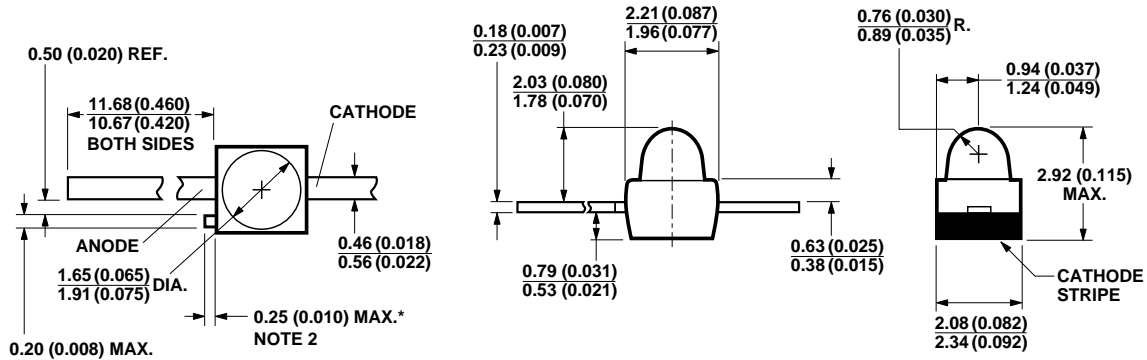

- NOTES:
 1. ALL DIMENSIONS ARE IN MILLIMETRES (INCHES).
 2. PROTRUDING SUPPORT TAB IS CONNECTED TO CATHODE LEAD.

* REFER TO FIGURE 1 FOR DESIGN CONCERNS.

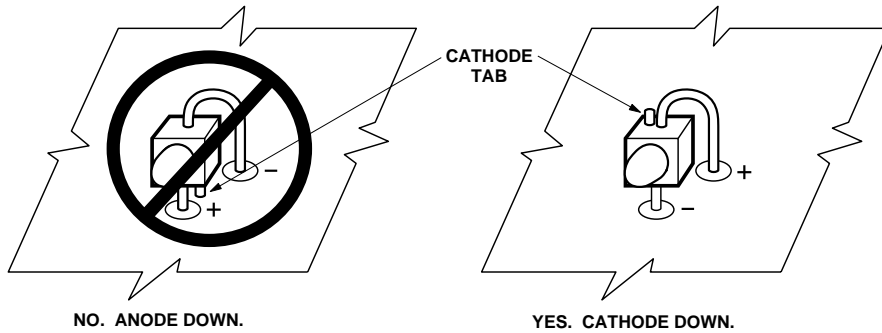

Figure 1. Proper Right Angle Mounting to a PC Board to Prevent Protruding Cathode Tab from Shorting to Anode Connection.

Absolute Maximum Ratings at $T_A = 25^\circ\text{C}$

Parameter	Standard Red	DHAS AlGaAs Red	High Eff. Red	Orange	Yellow	High Perf. Green	Emerald Green	Units
DC Forward Current ^[1]	50	30	30	30	20	30	30	mA
Peak Forward Current ^[2]	1000	300	90	90	60	90	90	mA
DC Forward Voltage (Resistor Lamps Only)			6		6	6	6	V
Reverse Voltage ($I_R = 100 \mu\text{A}$)	5	5	5	5	5	5	5	V
Transient Forward Current ^[3] (10 μs Pulse)	2000	500	500	500	500	500	500	mA
Operating Temperature Range: Non-Resistor Lamps	-55 to +100	-40 to +100	-55 to +100			-40 to +100	-20 to +100	°C
Resistor Lamps			-40 to +85			-20 to +85		
Storage Temperature Range	-55 to +100							°C
For Thru Hole Devices Wave Soldering Temperature [1.6 mm (0.063 in.) from body]	260°C for 5 Seconds							
For Surface Mount Devices: Convective IR	235°C for 90 Seconds							
Vapor Phase	215°C for 3 Minutes							

Notes:

1. See Figure 5 for current derating vs. ambient temperature. Derating is not applicable to resistor lamps.
2. Refer to Figure 6 showing Max. Tolerable Peak Current vs. Pulse Duration to establish pulsed operating conditions.
3. The transient peak current is the maximum non-recurring peak current the device can withstand without failure. Do not operate these lamps at this high current.

Electrical/Optical Characteristics, $T_A = 25^\circ\text{C}$

Standard Red

Device HLMP-	Parameter	Symbol	Min.	Typ.	Max.	Units	Test Conditions
6000	Luminous Intensity ^[1]	I_v	0.5	1.2		mcd	$I_F = 10 \text{ mA}$
6001			1.3	3.2			
All	Forward Voltage	V_F	1.4	1.6	2.0	V	$I_F = 10 \text{ mA}$
	Reverse Breakdown Voltage	V_R	5.0	12.0		V	$I_R = 100 \mu\text{A}$
P005	Included Angle Between Half Intensity Points ^[2]	$2\theta^{1/2}$		125		Deg.	
All Others				90			
All	Peak Wavelength	λ_{PEAK}		655		nm	
	Dominant Wavelength ^[3]	λ_d		640		nm	
	Spectral Line Half Width	$\Delta\lambda_{1/2}$		24		nm	
	Speed of Response	τ_s		15		ns	
	Capacitance	C		100		pF	$V_F = 0; f = 1 \text{ MHz}$
	Thermal Resistance	$R\theta_{\text{J-PIN}}$		170		$^\circ\text{C/W}$	Junction-to-Cathode Lead
	Luminous Efficacy ^[4]	η_v		65		lm/W	

DHASAlGaAs Red

Device HLMP-	Parameter	Symbol	Min.	Typ.	Max.	Units	Test Conditions
P102	Luminous Intensity	I_v	4.0	20.0		mcd	$I_F = 20 \text{ mA}$
P105			8.6	30.0			
Q101			22.0	45.0			
Q105			40	200			$I_F = 1 \text{ mA}$
Q150			1.0	1.8			
Q155			2.0	4.0			
Q101	Forward Voltage	V_F		1.8	2.2	V	$I_F = 20 \text{ mA}$
P205/P505 Q101/Q105				1.8	2.2		$I_F = 1 \text{ mA}$
Q150/Q155				1.6	1.8		
All	Reverse Breakdown Voltage	V_R	5.0	15.0		V	$I_R = 100 \mu\text{A}$
P105	Included Angle Between Half Intensity Points ^[2]	$2\theta^{1/2}$		125		Deg.	
Q101/Q150				90			
Q105/Q155				28			
All	Peak Wavelength	λ_{PEAK}		645		nm	Measured at Peak
	Dominant Wavelength ^[3]	λ_d		637		nm	
	Spectral Line Half Width	$\Delta\lambda_{1/2}$		20		nm	
	Speed of Response	τ_s		30		ns	Exponential Time Constant; e^{-t/τ_s}
	Capacitance	C		30		pF	$V_F = 0$; $f = 1 \text{ MHz}$
	Thermal Resistance	$R\theta_{\text{J-PIN}}$		170		$^{\circ}\text{C/W}$	Junction-to Cathode Lead
	Luminous Efficacy ^[4]	η_v		80		lm/W	

High Efficiency Red

Device HLMP-	Parameter	Symbol	Min.	Typ.	Max.	Units	Test Conditions
P202	Luminous Intensity ^[1]	I_v	1.0	5.0		mcd	$I_F = 10 \text{ mA}$
P205			1.0	8.0			
6300			1.0	10.0			
6305			10.0	40.0			
7000			0.4	1.0			$I_F = 2 \text{ mA}$
6600			1.3	5.0			$V_F = 5.0 \text{ Volts}$
6620			0.8	2.0			
6653 to 6658			1.0	3.0			$I_F = 10 \text{ mA}$
All	Forward Voltage (Nonresistor Lamps)	V_F	1.5	1.8	3.0	V	$I_F = 10 \text{ mA}$
6600	Forward Current (Resistor Lamps)	I_F		9.6	13.0	mA	$V_F = 5.0 \text{ V}$
6620				3.5	5.0		
All	Reverse Breakdown Voltage	V_R	5.0	30.0		V	$I_R = 100 \mu\text{A}$
P205	Included Angle Between Half Intensity Points ^[2]	$2\theta^{1/2}$		125		Deg.	
6305				28			
All Diffused				90			
All	Peak Wavelength	λ_{PEAK}		635		nm	Measured at Peak
	Dominant Wavelength ^[3]	λ_d		626		nm	
	Spectral Line Half Width	$\Delta\lambda_{1/2}$		40		nm	
	Speed of Response	τ_s		90		ns	
	Capacitance	C		11		pF	$V_F = 0; f = 1 \text{ MHz}$
	Thermal Resistance	$R\theta_{\text{J-PIN}}$		170		$^{\circ}\text{C/W}$	Junction-to-Cathode Lead
	Luminous Efficacy ^[4]	η_v		145		lm/W	

Orange

Device HLMP-	Parameter	Symbol	Min.	Typ.	Max.	Units	Test Conditions
P402	Luminous Intensity	I_v	1.0	4.0		mcd	$I_F = 10 \text{ mA}$
P405			1.0	6			
Q400			1.0	8			
All	Forward Voltage	V_F	1.5	1.9	3.0	V	$I_F = 10 \text{ mA}$
	Reverse Breakdown Voltage	V_R	5.0	30.0		V	$I_R = 100 \mu\text{A}$
P405	Included Angle Between Half Intensity Points ^[2]	$2\theta^{1/2}$		125		Deg.	
Q400				90			
All	Peak Wavelength	λ_{PEAK}		600		nm	
	Dominant Wavelength ^[3]	λ_d		602		nm	Measured at Peak
	Spectral Line Half Width	$\Delta\lambda_{1/2}$		40		nm	
	Speed of Response	τ_s		260		ns	
	Capacitance	C		4		pF	$V_F = 0; f = 1 \text{ MHz}$
	Thermal Resistance	$R\theta_{\text{J-PIN}}$		170		$^{\circ}\text{C/W}$	Junction-to-Cathode Lead
	Luminous Efficacy ^[4]	η_v		380		lm/W	

Yellow

Device HLMP-	Parameter	Symbol	Min.	Typ.	Max.	Units	Test Conditions
P302	Luminous Intensity ^[1]	I_v	1.0	3.0		mcd	$I_F = 10 \text{ mA}$
P305			1.0	4.0			
6400			1.0	9.0			
6405			3.6	20			$I_F = 2 \text{ mA}$
7019			0.4	0.6			
6700			1.4	5.0			$V_F = 5.0 \text{ Volts}$
6720			0.9	2.0			$I_F = 10 \text{ mA}$
6753 to 6758			1.0	3.0			
All	Forward Voltage (Nonresistor Lamps)	V_F		2.0	2.4	V	$I_F = 10 \text{ mA}$
6700	Forward Current (Resistor Lamps)	I_F		9.6	13.0	mA	$V_F = 5.0 \text{ V}$
6720				3.5	5.0		
All	Reverse Breakdown Voltage	V_R	5.0	50.0		V	
P305	Included Angle Between Half Intensity Points ^[2]	$2\theta^{1/2}$		125		Deg.	
6405				28			
All Diffused				90			
All	Peak Wavelength	λ_{PEAK}		583		nm	Measured at Peak
	Dominant Wavelength ^[3]	λ_d		585		nm	
	Spectral Line Half Width	$\Delta\lambda_{1/2}$		36		nm	
	Speed of Response	τ_s		90		ns	
	Capacitance	C		15		pF	$V_F = 0; f = 1 \text{ MHz}$
	Thermal Resistance	$R\theta_{\text{J-PIN}}$		170		°C/W	Junction-to-Cathode Lead
	Luminous Efficacy ^[4]	η_v		500		lm/W	

High Performance Green

Device HLMP-	Parameter	Symbol	Min.	Typ.	Max.	Units	Test Conditions
P502	Luminous Intensity ^[1]	I_v	1.0	3.0		mcd	$I_F = 10 \text{ mA}$
P505			1.6	6.3			
6500			1.0	7.0			
6505			10.0	40.0			
7040			0.4	0.6			$I_F = 2 \text{ mA}$
6800			1.6	5.0			$V_F = 5.0 \text{ Volts}$
6820			0.8	2.0			
6853 to 6858			1.0	3.0			$I_F = 10 \text{ mA}$
All	Forward Voltage (Nonresistor Lamps)	V_F		2.1	2.7	V	$I_F = 10 \text{ mA}$
6800	Forward Current (Resistor Lamps)	I_F		9.6	13.0	mA	$V_F = 5.0 \text{ V}$
6820				3.5	5.0		
All	Reverse Breakdown Voltage	V_R	5.0	50.0		V	$I_R = 100 \mu\text{A}$
P505	Included Angle Between Half Intensity Points ^[2]	$2\theta^{1/2}$		125		Deg.	
6505				28			
All Diffused				90			
All	Peak Wavelength	λ_{PEAK}		565		nm	
	Dominant Wavelength ^[3]	λ_d		569		nm	
	Spectral Line Half Width	$\Delta\lambda_{1/2}$		28		nm	
	Speed of Response	τ_s		500		ns	
	Capacitance	C		18		pF	$V_F = 0; f = 1 \text{ MHz}$
	Thermal Resistance	$R\theta_{\text{J-PIN}}$		170		$^{\circ}\text{C/W}$	Junction-to-Cathode Lead
	Luminous Efficacy ^[4]	η_v		595		lm/W	

Notes:

- The luminous intensity for arrays is tested to assure a 2.1 to 1.0 matching between elements. The average luminous intensity for an array determines its light output category bin. Arrays are binned for luminous intensity to allow I_v matching between arrays.
- $\theta^{1/2}$ is the off-axis angle where the luminous intensity is half the on-axis value.
- Dominant wavelength, λ_d , is derived from the CIE Chromaticity Diagram and represents the single wavelength that defines the color of the device.
- Radiant intensity, I_e , in watts/steradian, may be calculated from the equation $I_e = I_v / \eta_v$, where I_v is the luminous intensity in candelas and η_v is the luminous efficacy in lumens/watt.

Emerald Green^[1]

Device HLMP-	Parameter	Symbol	Min.	Typ.	Max.	Units	Test Conditions
P605	Luminous Intensity	I_v	1.0	1.5		mcd	$I_F = 10 \text{ mA}$
Q600			1.0	1.5			
	Forward Voltage	V_F		2.2	3.0	V	$I_F = 10 \text{ mA}$
	Reverse Breakdown Voltage	V_R	5.0			V	$I_R = 100 \mu\text{A}$
P605	Included Angle Between Half Intensity Points ^[2]	$2\theta^{1/2}$		125		Deg.	
Q600				90			
P605/ Q600	Peak Wavelength	λ_{PEAK}		558		nm	
	Dominant Wavelength ^[3]	λ_d		560		nm	Measured at Peak
	Spectral Line Half Width	$\Delta\lambda_{1/2}$		24		nm	
	Speed of Response	τ_s		3100		ns	
	Capacitance	C		35		pF	$V_F = 0$; $f = 1 \text{ MHz}$
	Thermal Resistance	$R\theta_{\text{J-PIN}}$		170		$^{\circ}\text{C/W}$	Junction-to-Cathode Lead
	Luminous Efficacy ^[4]	η_v		656		lm/W	

Note:

1. Please refer to Application Note 1061 for information comparing standard green and emerald green light output degradation.

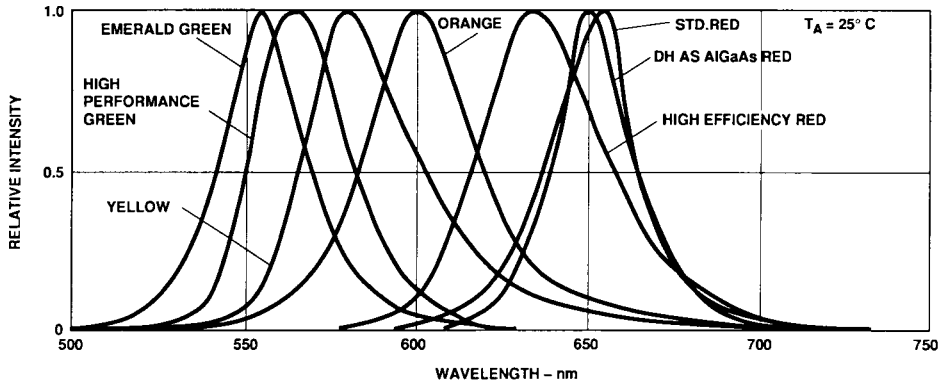

Figure 1. Relative Intensity vs. Wavelength.

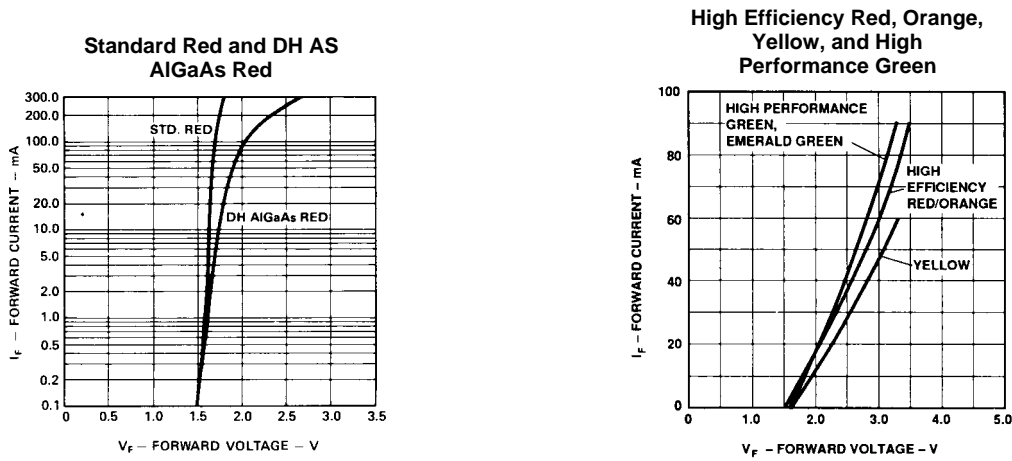

Figure 2. Forward Current vs. Forward Voltage. (Non-Resistor Lamp)

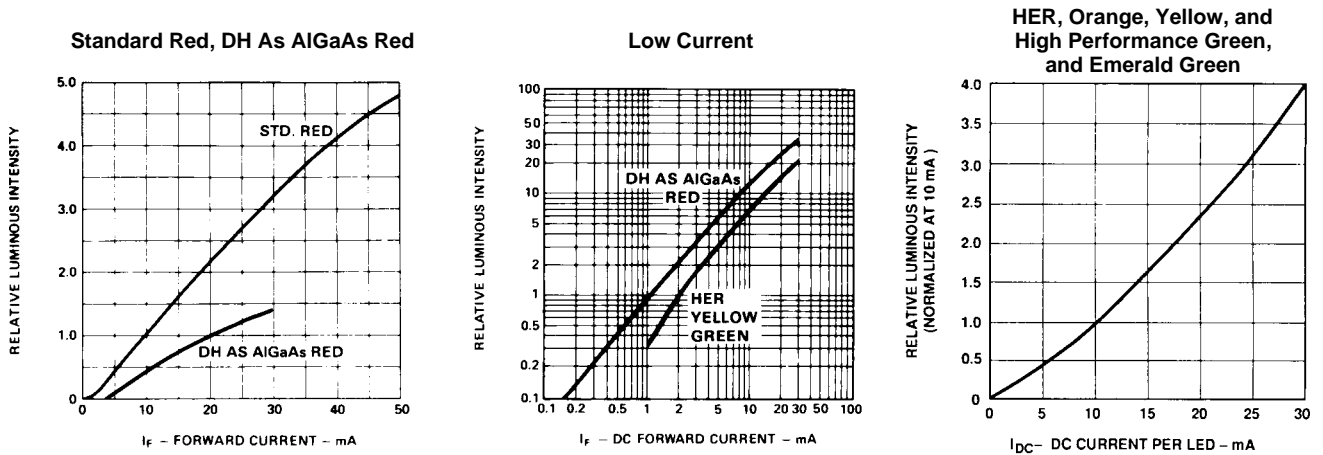

Figure 3. Relative Luminous Intensity vs. Forward Current. (Non-Resistor Lamp)

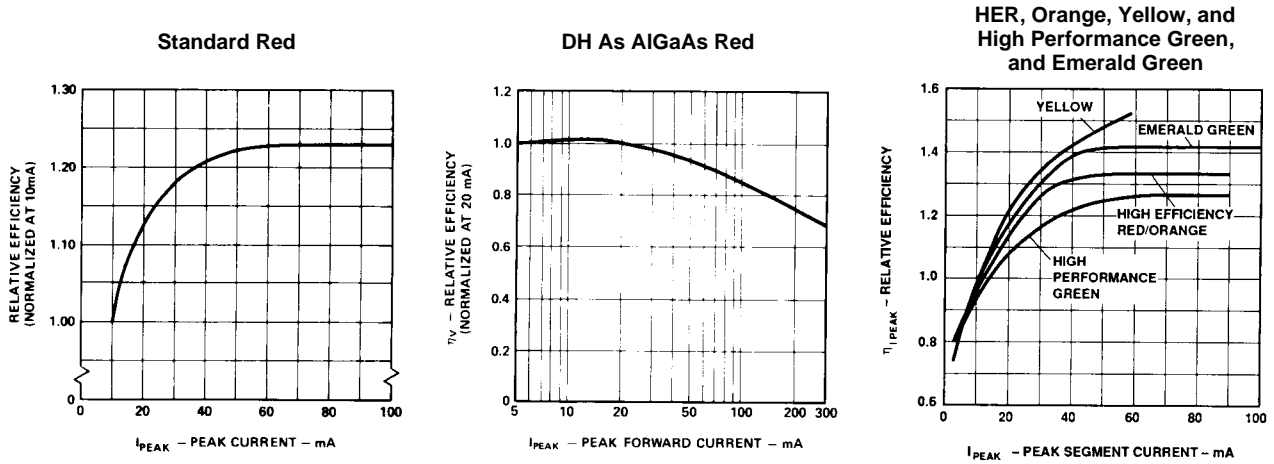
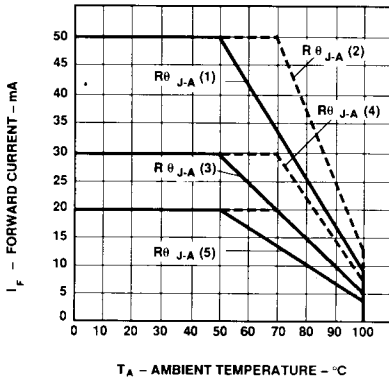

Figure 4. Relative Efficiency (Luminous Intensity per Unit Current) vs. Peak Current (Non-Resistor Lamps).



R _{θ J-A} (X)	STD RED	AlGaAs RED	HI-EFF RED	ORANGE	YELLOW	GREEN	UNITS
1	600						°C/W LED JUNCTION TO AMBIENT
2	400						
3		689	444	444	470	444	
4		559	296	296		296	
5					705		

Figure 5. Maximum Forward dc Current vs. Ambient Temperature. Derating Based on T_J MAX = 110 °C (Non-Resistor Lamps).

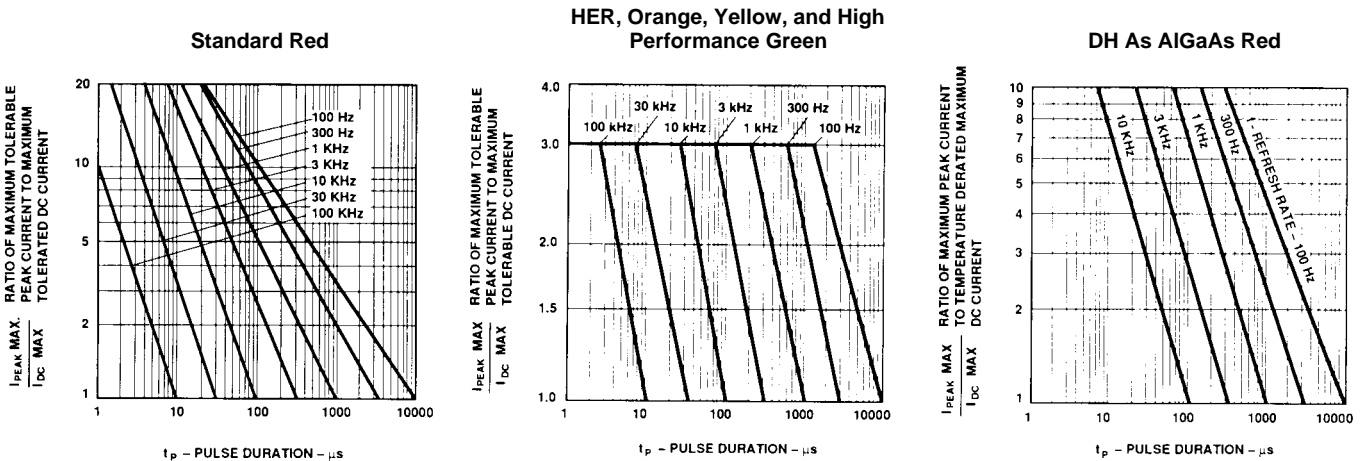

Figure 6. Maximum Tolerable Peak Current vs. Pulse Duration. (I_{DC} MAX as per MAX Ratings) (Non-Resistor Lamps).

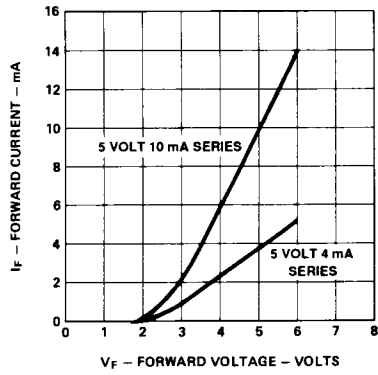

Figure 7. Resistor Lamp Forward Current vs. Forward Voltage.

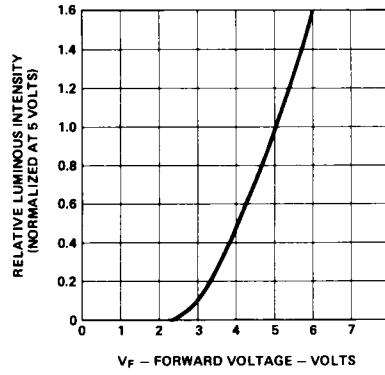

Figure 8. Resistor Lamp Luminous Intensity vs. Forward Voltage.

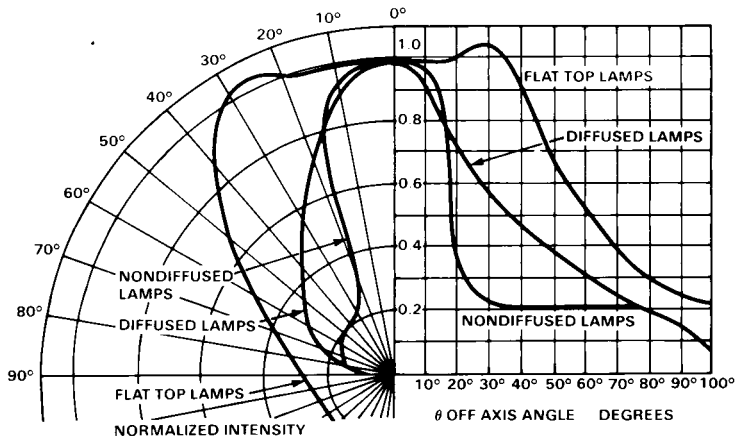
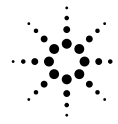

Figure 9. Relative Intensity vs. Angular Displacement.



Agilent Technologies

Innovating the HP Way

www.semiconductor.agilent.com

Data subject to change.

Copyright © 1999 Agilent Technologies

Obsoletes 5968-2537E (2/96)

5968-7825E (11/99)

HP LED PART-NUMBER CHANGE CROSS-REFERENCE LISTRevision 2.0^[5] (11 May 1999)

Old Part Number^[4]	New Part Number
5082-5663	5082-5663
5082-5666	5082-5666
5082-5680	5082-5680
5082-7610	5082-7610
5082-7610#S01	5082-7610-DD000
5082-7610#S02	5082-7610-CD000
5082-7611	5082-7611
5082-7611#S01	5082-7611-DD000
5082-7611#S02	5082-7611-CD000
5082-7613	5082-7613
5082-7613#S01	5082-7613-DD000
5082-7613#S02	5082-7613-CD000
5082-7616	5082-7616
5082-7616#S01	5082-7616-DD000
5082-7616#S02	5082-7616-CD000
5082-7620	5082-7620
5082-7621	5082-7621
5082-7623	5082-7623
5082-7626	5082-7626
5082-7650	5082-7650
5082-7650	5082-7650-DD000
5082-7650#S02	5082-7650-DE000
5082-7651	5082-7651
5082-7651#S01	5082-7651-DD000
5082-7651#S02	5082-7651-DE000
5082-7653	5082-7653
5082-7653#S01	5082-7653-DD000
5082-7653#S02	5082-7653-DE000
5082-7656	5082-7656
5082-7656#S01	5082-7656-DD000
5082-7656#S02	5082-7656-DE000
5082-7660	5082-7660
5082-7660#S02	5082-7660-EF000
5082-7661	5082-7661
5082-7661#S02	5082-7661-EF000
5082-7663	5082-7663
5082-7663#S02	5082-7663-EF000
5082-7663#S20	5082-7663-D0B00
5082-7666	5082-7666
5082-7666#S02	5082-7666-EF000
5082-7666#S20	5082-7666-D0B00
HCMS-2901	HCMS-2901
HCMS-2902	HCMS-2902
HCMS-2903	HCMS-2903
HCMS-2904	HCMS-2904
HCMS-2905	HCMS-2905
HCMS-2911	HCMS-2911
HCMS-2912	HCMS-2912

NOTES^[1] New Part Added^[2] Revised^[3] Omitted From List; Old Part Number To Be Retained^[4] List Sorted By Old Part Numbers^[5] This Is The Final Revision For This Part Number Change

HP LED PART-NUMBER CHANGE CROSS-REFERENCE LISTRevision 2.0^[5] (11 May 1999)

Old Part Number^[4]	New Part Number
HCMS-2912#S02	HCMS-2912-EF000
HCMS-2913	HCMS-2913
HCMS-2914	HCMS-2914
HCMS-2915	HCMS-2915
HCMS-2921	HCMS-2921
HCMS-2922	HCMS-2922
HCMS-2923	HCMS-2923
HCMS-2924	HCMS-2924
HCMS-2925	HCMS-2925
HCMS-2961	HCMS-2961
HCMS-2962	HCMS-2962
HCMS-2963	HCMS-2963
HCMS-2964	HCMS-2964
HCMS-2965	HCMS-2965
HCMS-2971	HCMS-2971
HCMS-2972	HCMS-2972
HCMS-2973	HCMS-2973
HCMS-2974	HCMS-2974
HCMS-2975	HCMS-2975
HCMS-2975#S02	HCMS-2975-HI000
HDLA-1414	HDLA-1414
HDLA-2416	HDLA-2416
HDLA-3416	HDLA-3416
HDLG-1414	HDLG-1414
HDLG-2416	HDLG-2416
HDLG-2416#S02	HDLG-2416-FG000
HDLG-3416	HDLG-3416
HDLO-1414	HDLO-1414
HDLO-2416	HDLO-2416
HDLO-3416	HDLO-3416
HDLS-1414	HDLS-1414
HDLS-2416	HDLS-2416
HDLU-1414	HDLU-1414
HDLU-2416	HDLU-2416
HDLY-1414	HDLY-1414
HDLY-2416	HDLY-2416
HDLY-2416#S02	HDLY-2416-CD000
HDLY-2416#S22	HDLY-2416-CDC00
HDLY-3416	HDLY-3416
HDSP-0760	HDSP-0760
HDSP-0761	HDSP-0761
HDSP-0762	HDSP-0762
HDSP-0763	HDSP-0763
HDSP-0770	HDSP-0770
HDSP-0771	HDSP-0771
HDSP-0772	HDSP-0772
HDSP-0781	HDSP-0781
HDSP-0782	HDSP-0782

NOTES^[1] New Part Added^[2] Revised^[3] Omitted From List; Old Part Number To Be Retained^[4] List Sorted By Old Part Numbers^[5] This Is The Final Revision For This Part Number Change

HP LED PART-NUMBER CHANGE CROSS-REFERENCE LISTRevision 2.0^[5] (11 May 1999)

Old Part Number^[4]	New Part Number
HDSP-0783	HDSP-0783
HDSP-0784	HDSP-0784
HDSP-0791	HDSP-0791
HDSP-0792	HDSP-0792
HDSP-0794	HDSP-0794
HDSP-0860	HDSP-0860
HDSP-0861	HDSP-0861
HDSP-0862	HDSP-0862
HDSP-0863	HDSP-0863
HDSP-0881	HDSP-0881
HDSP-0883	HDSP-0883
HDSP-0884	HDSP-0884
HDSP-0960	HDSP-0960
HDSP-0961	HDSP-0961
HDSP-0962	HDSP-0962
HDSP-0963	HDSP-0963
HDSP-0981	HDSP-0981
HDSP-0983	HDSP-0983
HDSP-0984	HDSP-0984
HDSP-2001	HDSP-2001
HDSP-2002	HDSP-2002
HDSP-2003	HDSP-2003
HDSP-2012	HDSP-2012
HDSP-2107	HDSP-2107
HDSP-2110	HDSP-2110
HDSP-2110#MFG	HDSP-2110-G00MF
HDSP-2111	HDSP-2111
HDSP-2111#C00	HDSP-2111-G00C0
HDSP-2111#F00	HDSP-2111-G00F0
HDSP-2111#S02	HDSP-2111-GH000
HDSP-2112	HDSP-2112
HDSP-2112#C00	HDSP-2112-G00C0
HDSP-2112#F00	HDSP-2112-G00F0
HDSP-2112#MFG	HDSP-2112-G00MF
HDSP-2112#S02	HDSP-2112-HI000
HDSP-2113	HDSP-2113
HDSP-2113#MFG	HDSP-2113-G00MF
HDSP-2113#S02	HDSP-2113-IJ000
HDSP-2116	HDSP-2112-IJ000
HDSP-2131	HDSP-2131
HDSP-2131#F00	HDSP-2131-G00F0
HDSP-2132	HDSP-2132
HDSP-2132#F00	HDSP-2132-G00F0
HDSP-2133	HDSP-2133
HDSP-2133#C00	HDSP-2133-G00C0
HDSP-2133#F00	HDSP-2133-G00F0
HDSP-2135	HDSP-2135
HDSP-2179	HDSP-2179

NOTES^[1] New Part Added^[2] Revised^[3] Omitted From List; Old Part Number To Be Retained^[4] List Sorted By Old Part Numbers^[5] This Is The Final Revision For This Part Number Change

HP LED PART-NUMBER CHANGE CROSS-REFERENCE LISTRevision 2.0^[5] (11 May 1999)

Old Part Number^[4]	New Part Number
HDSP-2203	HDSP-2203
HDSP-2245	HDSP-2245
HDSP-2301	HDSP-2301
HDSP-2302	HDSP-2302
HDSP-2303	HDSP-2303
HDSP-2311	HDSP-2311
HDSP-2312	HDSP-2312
HDSP-2500	HDSP-2500
HDSP-2501	HDSP-2501
HDSP-2502	HDSP-2502
HDSP-2503	HDSP-2503
HDSP-2504	HDSP-2504
HDSP-2530	HDSP-2530
HDSP-2531	HDSP-2531
HDSP-2532	HDSP-2532
HDSP-2533	HDSP-2533
HDSP-2533#S02	HDSP-2533-IJ000
HDSP-2533#S22	HDSP-2533-IJA00
HDSP-2534	HDSP-2534
HDSP-2534#F00	HDSP-2534-I00F0
HDSP-315E	HDSP-315E
HDSP-315E#S02	HDSP-315E-KL000
HDSP-315G	HDSP-315G
HDSP-315G#S02	HDSP-315G-LM000
HDSP-315H	HDSP-315H
HDSP-315H#S02	HDSP-315H-GH000
HDSP-315L	HDSP-315L
HDSP-315L#S02	HDSP-315L-FG000
HDSP-315Y	HDSP-315Y
HDSP-315Y#S02	HDSP-315Y-KL000
HDSP-316E	HDSP-316E
HDSP-316E#S02	HDSP-316E-KL000
HDSP-316G	HDSP-316G
HDSP-316G#S02	HDSP-316G-LM000
HDSP-316H	HDSP-316H
HDSP-316H#S02	HDSP-316H-GH000
HDSP-316L	HDSP-316L
HDSP-316L#S02	HDSP-316L-FG000
HDSP-316Y	HDSP-316Y
HDSP-316Y#S02	HDSP-316Y-KL000
HDSP-3350	HDSP-3350
HDSP-3351	HDSP-3351
HDSP-3353	HDSP-3353
HDSP-3356	HDSP-3356
HDSP-3600	HDSP-3600
HDSP-3600#S02	HDSP-3600-KL000
HDSP-3601	HDSP-3601
HDSP-3601#S02	HDSP-3601-KL000

NOTES^[1] New Part Added^[2] Revised^[3] Omitted From List; Old Part Number To Be Retained^[4] List Sorted By Old Part Numbers^[5] This Is The Final Revision For This Part Number Change

HP LED PART-NUMBER CHANGE CROSS-REFERENCE LISTRevision 2.0^[5] (11 May 1999)

Old Part Number^[4]	New Part Number
HDSP-3603	HDSP-3603
HDSP-3603#S02	HDSP-3603-KL000
HDSP-3606	HDSP-3606
HDSP-3606#S02	HDSP-3606-KL000
HDSP-3800	5082-7650-CD000
HDSP-3802	5082-7651-CD000
HDSP-3900	HDSP-3900
HDSP-3900#S02	HDSP-3900-EF000
HDSP-3901	HDSP-3901
HDSP-3901#S02	HDSP-3901-EF000
HDSP-3903	HDSP-3903
HDSP-3903#S02	HDSP-3903-EF000
HDSP-3905	HDSP-3905
HDSP-3905#S02	HDSP-3905-EF000
HDSP-3906	HDSP-3906
HDSP-3906#S02	HDSP-3906-EF000
HDSP-4030	HDSP-4030
HDSP-4031	HDSP-4031
HDSP-4033	HDSP-4033
HDSP-4130	HDSP-4130
HDSP-4131	HDSP-4131
HDSP-4136	HDSP-4136
HDSP-4200	HDSP-4200
HDSP-4201	HDSP-4201
HDSP-4203	HDSP-4203
HDSP-4205	HDSP-4205
HDSP-4206	HDSP-4206
HDSP-4501	HDSP-4501
HDSP-4503	HDSP-4503
HDSP-4600	HDSP-4600
HDSP-4600#S02	HDSP-4600-IJ000
HDSP-4601	HDSP-4601
HDSP-4601#S02	HDSP-4601-IJ000
HDSP-4603	HDSP-4603
HDSP-4603#S02	HDSP-4603-IJ000
HDSP-4606	HDSP-4606
HDSP-4606#S02	HDSP-4606-IJ000
HDSP-4830	HDSP-4830
HDSP-4830#S01	HDSP-4830-HH000
HDSP-4830#S02	HDSP-4830-GH000
HDSP-4832	HDSP-4832
HDSP-4833	HDSP-4833
HDSP-4836	HDSP-4836
HDSP-4840	HDSP-4840
HDSP-4840#S02	HDSP-4840-FG000
HDSP-4840#S22	HDSP-4840-FGB00
HDSP-4847	HDSP-4847
HDSP-4848	HDSP-4848

NOTES^[1] New Part Added^[2] Revised^[3] Omitted From List; Old Part Number To Be Retained^[4] List Sorted By Old Part Numbers^[5] This Is The Final Revision For This Part Number Change

HP LED PART-NUMBER CHANGE CROSS-REFERENCE LIST

Revision 2.0^[5] (11 May 1999)

Old Part Number^[4]	New Part Number
HDSP-4850	HDSP-4850
HDSP-4850#S02	HDSP-4850-HI000
HDSP-4850#S22	HDSP-4850-HIC00
HDSP-4935	HDSP-4830-GH000
HDSP-4950	HDSP-4950
HDSP-5101	HDSP-5101
HDSP-5103	HDSP-5103
HDSP-515E	HDSP-515E
HDSP-515E#S02	HDSP-515E-KL000
HDSP-515G	HDSP-515G
HDSP-515G#S02	HDSP-515G-LM000
HDSP-515H	HDSP-515H
HDSP-515H#S02	HDSP-515H-GH000
HDSP-515L	HDSP-515L
HDSP-515L#S02	HDSP-515L-FG000
HDSP-515Y	HDSP-515Y
HDSP-515Y#S02	HDSP-515Y-IJ000
HDSP-516E	HDSP-516E
HDSP-516E#S02	HDSP-516E-KL000
HDSP-516G	HDSP-516G
HDSP-516G#S02	HDSP-516G-LM000
HDSP-516H ^[1]	HDSP-516H
HDSP-516H#S02 ^[1]	HDSP-516H-GH000
HDSP-516L	HDSP-516L
HDSP-516L#S02	HDSP-516L-FG000
HDSP-516Y	HDSP-516Y
HDSP-516Y#S02	HDSP-516Y-IJ000
HDSP-5401	HDSP-5401
HDSP-5403	HDSP-5403
HDSP-5501	HDSP-5501
HDSP-5501#S01	HDSP-5501-GG000
HDSP-5501#S02	HDSP-5501-GH000
HDSP-5503	HDSP-5503
HDSP-5503#S01	HDSP-5503-GG000
HDSP-5503#S02	HDSP-5503-GH000
HDSP-5507	HDSP-5507
HDSP-5507#S01	HDSP-5507-GG000
HDSP-5507#S02	HDSP-5507-GH000
HDSP-5508	HDSP-5508
HDSP-5508#S01	HDSP-5508-GG000
HDSP-5508#S02	HDSP-5508-GH000
HDSP-5521	HDSP-5521
HDSP-5521#S01	HDSP-5521-GG000
HDSP-5521#S02	HDSP-5521-GH000
HDSP-5523	HDSP-5523
HDSP-5523#S01	HDSP-5523-GG000
HDSP-5523#S02	HDSP-5523-GH000

NOTES

^[1] New Part Added

^[2] Revised

^[3] Omitted From List; Old Part Number To Be Retained

^[4] List Sorted By Old Part Numbers

^[5] This Is The Final Revision For This Part Number Change

HP LED PART-NUMBER CHANGE CROSS-REFERENCE LIST

Revision 2.0^[5] (11 May 1999)

Old Part Number^[4]	New Part Number
HDSP-5540	HDSP-5501-FG000
HDSP-5542	HDSP-5503-FG000
HDSP-5544	HDSP-5507-FG000
HDSP-5551	HDSP-5551
HDSP-5551#S02	HDSP-5551-BC000
HDSP-5553	HDSP-5553
HDSP-5557	HDSP-5557
HDSP-5558	HDSP-5558
HDSP-5601	HDSP-5601
HDSP-5601#S02	HDSP-5601-GH000
HDSP-5603	HDSP-5603
HDSP-5603#S02	HDSP-5603-GH000
HDSP-5607	HDSP-5607
HDSP-5607#S02	HDSP-5607-GH000
HDSP-5608	HDSP-5608
HDSP-5608#S02	HDSP-5608-GH000
HDSP-5621	HDSP-5621
HDSP-5621#S02	HDSP-5621-GH000
HDSP-5623	HDSP-5623
HDSP-5623#S02	HDSP-5623-GH000
HDSP-5701	HDSP-5701
HDSP-5701#S02	HDSP-5701-FG000
HDSP-5703	HDSP-5703
HDSP-5703#S02	HDSP-5703-FG000
HDSP-5707	HDSP-5707
HDSP-5707#S02	HDSP-5707-FG000
HDSP-5708	HDSP-5708
HDSP-5708#S02	HDSP-5708-FG000
HDSP-5721	HDSP-5721
HDSP-5721#S02	HDSP-5721-FG000
HDSP-5723	HDSP-5723
HDSP-5731	HDSP-5731
HDSP-5733	HDSP-5733
HDSP-5737	HDSP-5737
HDSP-5738	HDSP-5738
HDSP-6699	HPDL-1414
HDSP-6707	HDLO-2416-DE000
HDSP-7401	HDSP-7401
HDSP-7401#S02	HDSP-7401-DE000
HDSP-7402	HDSP-7402
HDSP-7403	HDSP-7403
HDSP-7403#S02	HDSP-7403-DE000
HDSP-7404	HDSP-7404
HDSP-7407	HDSP-7407
HDSP-7407#S02	HDSP-7407-DE000
HDSP-7408	HDSP-7408
HDSP-7408#S02	HDSP-7408-DE000
HDSP-7501	HDSP-7501

NOTES

^[1] New Part Added

^[2] Revised

^[3] Omitted From List; Old Part Number To Be Retained

^[4] List Sorted By Old Part Numbers

^[5] This Is The Final Revision For This Part Number Change

HP LED PART-NUMBER CHANGE CROSS-REFERENCE LIST

Revision 2.0^[5] (11 May 1999)

Old Part Number^[4]	New Part Number
HDSP-7501#S02	HDSP-7501-CD000
HDSP-7502	HDSP-7502
HDSP-7502#S01	HDSP-7502-DD000
HDSP-7502#S02	HDSP-7502-CD000
HDSP-7503	HDSP-7503
HDSP-7503#S01	HDSP-7503-DD000
HDSP-7503#S02	HDSP-7503-CD000
HDSP-7504	HDSP-7504
HDSP-7504#S02	HDSP-7504-CD000
HDSP-7507	HDSP-7507
HDSP-7507#S01	HDSP-7507-DD000
HDSP-7507#S02	HDSP-7507-CD000
HDSP-7508	HDSP-7508
HDSP-7508#S01	HDSP-7508-DD000
HDSP-7508#S02	HDSP-7508-CD000
HDSP-7511	HDSP-7511
HDSP-7513	HDSP-7513
HDSP-7513#S02	HDSP-7513-CD000
HDSP-7517	HDSP-7517
HDSP-7518	HDSP-7518
HDSP-7801	HDSP-7801
HDSP-7801#S02	HDSP-7801-JK000
HDSP-7802	HDSP-7802
HDSP-7802#S02	HDSP-7802-JK000
HDSP-7803	HDSP-7803
HDSP-7803#S02	HDSP-7803-JK000
HDSP-7804	HDSP-7804
HDSP-7807	HDSP-7807
HDSP-7807#S02	HDSP-7807-JK000
HDSP-7808	HDSP-7808
HDSP-7808#S02	HDSP-7808-JK000
HDSP-8600	HDSP-8600
HDSP-8601	HDSP-8601
HDSP-8601#S02	HDSP-8601-EF000
HDSP-8603	HDSP-8603
HDSP-8603#S02	HDSP-8603-EF000
HDSP-8605	HDSP-8605
HDSP-8606	HDSP-8606
HDSP-8606#S02	HDSP-8606-EF000
HDSP-A101	HDSP-A101
HDSP-A101#S02	HDSP-A101-FG000
HDSP-A103	HDSP-A103
HDSP-A103#S02	HDSP-A103-FG000
HDSP-A107	HDSP-A107
HDSP-A107#S02	HDSP-A107-FG000
HDSP-A108	HDSP-A108
HDSP-A108#S02	HDSP-A108-FG000
HDSP-A111	HDSP-A111

NOTES

^[1] New Part Added

^[2] Revised

^[3] Omitted From List; Old Part Number To Be Retained

^[4] List Sorted By Old Part Numbers

^[5] This Is The Final Revision For This Part Number Change

HP LED PART-NUMBER CHANGE CROSS-REFERENCE LISTRevision 2.0^[5] (11 May 1999)

Old Part Number^[4]	New Part Number
HDSP-A113	HDSP-A113
HDSP-A151	HDSP-A151
HDSP-A151#S02	HDSP-A151-NO000
HDSP-A153	HDSP-A153
HDSP-A153#S02	HDSP-A153-NO000
HDSP-A157	HDSP-A157
HDSP-A157#S02	HDSP-A157-NO000
HDSP-A158	HDSP-A158
HDSP-A158#S02	HDSP-A158-NO000
HDSP-A211	HDSP-A211
HDSP-A211#S02	HDSP-A211-CD000
HDSP-A213	HDSP-A213
HDSP-A213#S02	HDSP-A213-CD000
HDSP-A401	HDSP-A401
HDSP-A403	HDSP-A403
HDSP-A407	HDSP-A407
HDSP-A408	HDSP-A408
HDSP-A411	HDSP-A411
HDSP-A413 ^[1]	HDSP-A413
HDSP-A511	HDSP-A511
HDSP-A511#S02	HDSP-A511-JK000
HDSP-A513	HDSP-A513
HDSP-A513#S02	HDSP-A513-JK000
HDSP-A801	HDSP-A801
HDSP-A803	HDSP-A803
HDSP-A807	HDSP-A807
HDSP-A808	HDSP-A808
HDSP-A901	HDSP-A901
HDSP-A903	HDSP-A903
HDSP-A907	HDSP-A907
HDSP-A908	HDSP-A908
HDSP-E100	HDSP-E100
HDSP-E100#S02	HDSP-E100-EF000
HDSP-E101	HDSP-E101
HDSP-E101#S02	HDSP-E101-EF000
HDSP-E103	HDSP-E103
HDSP-E103#S02	HDSP-E103-EF000
HDSP-E106	HDSP-E106
HDSP-E106#S02	HDSP-E106-EF000
HDSP-E150	HDSP-E150
HDSP-E150#S02	HDSP-E150-LM000
HDSP-E151	HDSP-E151
HDSP-E153	HDSP-E153
HDSP-E156	HDSP-E156
HDSP-F101	HDSP-F101
HDSP-F101#S02	HDSP-F101-EF000
HDSP-F103	HDSP-F103

NOTES^[1] New Part Added^[2] Revised^[3] Omitted From List; Old Part Number To Be Retained^[4] List Sorted By Old Part Numbers^[5] This Is The Final Revision For This Part Number Change

HP LED PART-NUMBER CHANGE CROSS-REFERENCE LIST

Revision 2.0^[5] (11 May 1999)

Old Part Number^[4]	New Part Number
HDSP-F103#S02	HDSP-F103-EF000
HDSP-F107	HDSP-F107
HDSP-F107#S02	HDSP-F107-EF000
HDSP-F108	HDSP-F108
HDSP-F108#S02	HDSP-F108-EF000
HDSP-F111	HDSP-F111
HDSP-F111#S02	HDSP-F111-EF000
HDSP-F113	HDSP-F113
HDSP-F113#S02	HDSP-F113-EF000
HDSP-F151	HDSP-F151
HDSP-F151#S02	HDSP-F151-MN000
HDSP-F153	HDSP-F153
HDSP-F153#S02	HDSP-F153-MN000
HDSP-F157	HDSP-F157
HDSP-F157#S02	HDSP-F157-MN000
HDSP-F158	HDSP-F158
HDSP-F158#S02	HDSP-F158-MN000
HDSP-F201	HDSP-F201
HDSP-F201#S02	HDSP-F201-DE000
HDSP-F203	HDSP-F203
HDSP-F203#S02	HDSP-F203-DE000
HDSP-F207	HDSP-F207
HDSP-F207#S02	HDSP-F207-DE000
HDSP-F208	HDSP-F208
HDSP-F208#S02	HDSP-F208-DE000
HDSP-F211	HDSP-F211
HDSP-F211#S02	HDSP-F211-DE000
HDSP-F213	HDSP-F213
HDSP-F213#S02	HDSP-F213-DE000
HDSP-F301	HDSP-F301
HDSP-F301#S02	HDSP-F301-DE000
HDSP-F303	HDSP-F303
HDSP-F303#S02	HDSP-F303-DE000
HDSP-F307	HDSP-F307
HDSP-F307#S02	HDSP-F307-DE000
HDSP-F308	HDSP-F308
HDSP-F308#S02	HDSP-F308-DE000
HDSP-F401	HDSP-F401
HDSP-F403	HDSP-F403
HDSP-F407	HDSP-F407
HDSP-F408	HDSP-F408
HDSP-F411	HDSP-F411
HDSP-F413	HDSP-F413
HDSP-F501	HDSP-F501
HDSP-F501#S02	HDSP-F501-JK000
HDSP-F503	HDSP-F503
HDSP-F503#S02	HDSP-F503-JK000
HDSP-F507	HDSP-F507

NOTES

^[1] New Part Added

^[2] Revised

^[3] Omitted From List; Old Part Number To Be Retained

^[4] List Sorted By Old Part Numbers

^[5] This Is The Final Revision For This Part Number Change

HP LED PART-NUMBER CHANGE CROSS-REFERENCE LIST

Revision 2.0^[5] (11 May 1999)

Old Part Number^[4]	New Part Number
HDSP-F507#S02	HDSP-F507-JK000
HDSP-F508	HDSP-F508
HDSP-F508#S02	HDSP-F508-JK000
HDSP-F511	HDSP-F511
HDSP-F511#S02	HDSP-F511-IJ000
HDSP-F513	HDSP-F513
HDSP-F513#S02	HDSP-F513-IJ000
HDSP-G101	HDSP-G101
HDSP-G101#S02	HDSP-G101-EF000
HDSP-G103	HDSP-G103
HDSP-G111	HDSP-G111
HDSP-G113	HDSP-G113
HDSP-G151	HDSP-G151
HDSP-G153	HDSP-G153
HDSP-G161	HDSP-G161
HDSP-G201	HDSP-G201
HDSP-G201#S02	HDSP-G201-DE000
HDSP-G203	HDSP-G203
HDSP-G203#S02	HDSP-G203-DE000
HDSP-G211	HDSP-G211
HDSP-G211#S02	HDSP-G211-DE000
HDSP-G213	HDSP-G213
HDSP-G213#S02	HDSP-G213-DE000
HDSP-G301	HDSP-G301
HDSP-G303	HDSP-G303
HDSP-G401	HDSP-G401
HDSP-G403	HDSP-G403
HDSP-G411	HDSP-G411
HDSP-G413	HDSP-G413
HDSP-G501	HDSP-G501
HDSP-G501#S02	HDSP-G501-JK000
HDSP-G503	HDSP-G503
HDSP-G503#S02	HDSP-G503-JK000
HDSP-G511	HDSP-G511
HDSP-G511#S02	HDSP-G511-IJ000
HDSP-G513	HDSP-G513
HDSP-G513#S02	HDSP-G513-IJ000
HDSP-H101	HDSP-H101
HDSP-H101#S02	HDSP-H101-DE000
HDSP-H103	HDSP-H103
HDSP-H103#S02	HDSP-H103-DE000
HDSP-H107	HDSP-H107
HDSP-H107#S02	HDSP-H107-DE000
HDSP-H108	HDSP-H108
HDSP-H108#S02	HDSP-H108-DE000
HDSP-H111	HDSP-H111
HDSP-H111#S02	HDSP-H111-DE000
HDSP-H113	HDSP-H113

NOTES

- ^[1] New Part Added
- ^[2] Revised
- ^[3] Omitted From List; Old Part Number To Be Retained
- ^[4] List Sorted By Old Part Numbers
- ^[5] This Is The Final Revision For This Part Number Change

HP LED PART-NUMBER CHANGE CROSS-REFERENCE LISTRevision 2.0^[5] (11 May 1999)

Old Part Number^[4]	New Part Number
HDSP-H113#S02	HDSP-H113-DE000
HDSP-H151	HDSP-H151
HDSP-H151#S02	HDSP-H151-KL000
HDSP-H153	HDSP-H153
HDSP-H153#S02	HDSP-H153-KL000
HDSP-H157	HDSP-H157
HDSP-H157#S02	HDSP-H157-KL000
HDSP-H158	HDSP-H158
HDSP-H158#S02	HDSP-H158-KL000
HDSP-H161	HDSP-H161
HDSP-H163	HDSP-H163
HDSP-H211	HDSP-H211
HDSP-H211#S02	HDSP-H211-GH000
HDSP-H213	HDSP-H213
HDSP-H213#S02	HDSP-H213-GH000
HDSP-H401	HDSP-H401
HDSP-H403	HDSP-H403
HDSP-H407	HDSP-H407
HDSP-H408	HDSP-H408
HDSP-H411	HDSP-H411
HDSP-H413	HDSP-H413
HDSP-H511	HDSP-H511
HDSP-H511#S02	HDSP-H511-GH000
HDSP-H513	HDSP-H513
HDSP-H513#S02	HDSP-H513-GH000
HDSP-K111	HDSP-K111
HDSP-K111#S02	HDSP-K111-DE000
HDSP-K113	HDSP-K113
HDSP-K113#S02	HDSP-K113-DE000
HDSP-K121	HDSP-K121
HDSP-K121#S02	HDSP-K121-DE000
HDSP-K123	HDSP-K123
HDSP-K123#S02	HDSP-K123-DE000
HDSP-K211	HDSP-K211
HDSP-K211#S02	HDSP-K211-GH000
HDSP-K213	HDSP-K213
HDSP-K213#S02	HDSP-K213-GH000
HDSP-K401	HDSP-K401
HDSP-K403	HDSP-K403
HDSP-K411	HDSP-K411
HDSP-K413	HDSP-K413
HDSP-K511	HDSP-K511
HDSP-K511#S02	HDSP-K511-GH000
HDSP-K513	HDSP-K513
HDSP-K513#S02	HDSP-K513-GH000
HDSP-K701	HDSP-K701
HDSP-L101	HDSP-L101
HDSP-L103	HDSP-L103

NOTES^[1] New Part Added^[2] Revised^[3] Omitted From List; Old Part Number To Be Retained^[4] List Sorted By Old Part Numbers^[5] This Is The Final Revision For This Part Number Change

HP LED PART-NUMBER CHANGE CROSS-REFERENCE LISTRevision 2.0^[5] (11 May 1999)

Old Part Number^[4]	New Part Number
HDSP-L201	HDSP-L201
HDSP-L203	HDSP-L203
HDSP-M101	HDSP-M101
HDSP-M103	HDSP-M103
HDSP-N100	HDSP-N100
HDSP-N100#S02	HDSP-N100-CD000
HDSP-N101	HDSP-N101
HDSP-N101#S02	HDSP-N101-CD000
HDSP-N103	HDSP-N103
HDSP-N103#S02	HDSP-N103-CD000
HDSP-N105	HDSP-N105
HDSP-N105#S02	HDSP-N105-CD000
HDSP-N106	HDSP-N106
HDSP-N106#S02	HDSP-N106-CD000
HDSP-N150	HDSP-N150
HDSP-N151	HDSP-N151
HDSP-N153	HDSP-N153
HDSP-N153#S02	HDSP-N153-KL000
HDSP-N155	HDSP-N155
HDSP-N156	HDSP-N156
HDSP-N401	HDSP-N401
HDSP-N403	HDSP-N403
HDSP-N406	HDSP-N406
HDSP-U101	HDSP-U101
HDSP-U101#S02	HDSP-U101-FG000
HDSP-U103	HDSP-U103
HDSP-U103#S02	HDSP-U103-FG000
HDSP-U111	HDSP-U111
HDSP-U111#S02	HDSP-U111-FG000
HDSP-U113	HDSP-U113
HDSP-U113#S02	HDSP-U113-FG000
HDSP-U201	HDSP-U201
HDSP-U201#S02	HDSP-U201-CD000
HDSP-U203	HDSP-U203
HDSP-U203#S02	HDSP-U203-CD000
HDSP-U211	HDSP-U211
HDSP-U211#S02	HDSP-U211-CD000
HDSP-U213	HDSP-U213
HDSP-U213#S02	HDSP-U213-CD000
HDSP-U301	HDSP-U301
HDSP-U303	HDSP-U303
HDSP-U311	HDSP-U311
HDSP-U313	HDSP-U313
HDSP-U401	HDSP-U401
HDSP-U403	HDSP-U403
HDSP-U411	HDSP-U411
HDSP-U413	HDSP-U413
HDSP-U501	HDSP-U501

NOTES^[1] New Part Added^[2] Revised^[3] Omitted From List; Old Part Number To Be Retained^[4] List Sorted By Old Part Numbers^[5] This Is The Final Revision For This Part Number Change

HP LED PART-NUMBER CHANGE CROSS-REFERENCE LIST

Revision 2.0^[5] (11 May 1999)

Old Part Number^[4]	New Part Number
HDSP-U501#S02	HDSP-U501-KL000
HDSP-U503	HDSP-U503
HDSP-U503#S02	HDSP-U503-KL000
HDSP-U511	HDSP-U511
HDSP-U511#S02	HDSP-U511-KL000
HDSP-U513	HDSP-U513
HDSP-U513#S02	HDSP-U513-KL000
HLCP-A100	HLCP-A100
HLCP-A100#S02	HLCP-A100-BC000
HLCP-B100	HLCP-B100
HLCP-B100#S02	HLCP-B100-BC000
HLCP-C100	HLCP-C100
HLCP-C100#S02	HLCP-C100-BC000
HLCP-D100	HLCP-D100
HLCP-D100#S02	HLCP-D100-BC000
HLCP-E100	HLCP-E100
HLCP-E100#S02	HLCP-E100-BC000
HLCP-F100	HLCP-F100
HLCP-F100#S02	HLCP-F100-BC000
HLCP-G100	HLCP-G100
HLCP-G100#S02	HLCP-G100-BC000
HLCP-H100	HLCP-H100
HLCP-H100#S02	HLCP-H100-BC000
HLCP-J100	HLCP-J100
HLCP-J100#S02	HLCP-J100-DE000
HLMA-PG00	HLMA-PG00
HLMA-PG00#011	HLMA-PG00-N0011
HLMA-PH00	HLMA-PH00
HLMA-PH00#011	HLMA-PH00-N0011
HLMA-PH00#014	HLMA-PH00-N0014
HLMA-PL00	HLMA-PL00
HLMA-PL00#011	HLMA-PL00-N0011
HLMA-PL00#012	HLMA-PL00-N0012
HLMA-PL00#021	HLMA-PL00-N0021
HLMA-PL00#031	HLMA-PL00-N0031
HLMA-QG00	HLMA-QG00
HLMA-QG00#011	HLMA-QG00-S0011
HLMA-QH00	HLMA-QH00
HLMA-QH00#011	HLMA-QH00-S0011
HLMA-QH00#012	HLMA-QH00-S0012
HLMA-QH00#021	HLMA-QH00-S0021
HLMA-QH00#031	HLMA-QH00-S0031
HLMA-QH00#1S1	HLMA-QH00-S001S
HLMA-QL00	HLMA-QL00
HLMA-QL00#011	HLMA-QL00-S0011
HLMA-QL00#012	HLMA-QL00-S0012
HLMA-QL00#021	HLMA-QL00-S0021
HLMA-QL00#031	HLMA-QL00-S0031

NOTES

^[1] New Part Added

^[2] Revised

^[3] Omitted From List; Old Part Number To Be Retained

^[4] List Sorted By Old Part Numbers

^[5] This Is The Final Revision For This Part Number Change

HP LED PART-NUMBER CHANGE CROSS-REFERENCE LIST

Revision 2.0^[5] (11 May 1999)

Old Part Number^[4]	New Part Number
HLMA-QL00#034	HLMA-QL00-S0034
HLMP-0300	HLMP-0301-C0000
HLMP-0300#002	HLMP-0301-C0002
HLMP-0300#S02	HLMP-0301-DE000
HLMP-0301	HLMP-0301
HLMP-0301#002	HLMP-0301-D0002
HLMP-0301#2DD	HLMP-0301-D00DD
HLMP-0400	HLMP-0401-B0000
HLMP-0400#002	HLMP-0401-B0002
HLMP-0400#S02	HLMP-0401-CD000
HLMP-0401	HLMP-0401
HLMP-0401#002	HLMP-0401-D0002
HLMP-0401#2DD	HLMP-0401-D00DD
HLMP-0401#S22	HLMP-0401-DEB00
HLMP-0405	HLMP-0405
HLMP-0503	HLMP-0504-B0000
HLMP-0503#002	HLMP-0504-B0002
HLMP-0503#S02	HLMP-0504-CD000
HLMP-0504	HLMP-0504
HLMP-0504#001	HLMP-0504-C0001
HLMP-0504#002	HLMP-0504-C0002
HLMP-0504#S22	HLMP-0504-DEC00
HLMP-1300	HLMP-1301
HLMP-1300#001	HLMP-1301-E0001
HLMP-1300#002	HLMP-1301-E0002
HLMP-1300#010	HLMP-1301-E00A1
HLMP-1300#101	HLMP-1301-E00A2
HLMP-1301	HLMP-1301
HLMP-1301#001	HLMP-1301-E0001
HLMP-1301#002	HLMP-1301-E0002
HLMP-1301#010	HLMP-1301-E00A1
HLMP-1301#101	HLMP-1301-E00A2
HLMP-1301#S02	HLMP-1301-GH000
HLMP-1302	HLMP-1301
HLMP-1302#001	HLMP-1301-E0001
HLMP-1302#002	HLMP-1301-E0002
HLMP-1302#010	HLMP-1301-E00A1
HLMP-1302#101	HLMP-1301-E00A2
HLMP-1302#2BG	HLMP-1301-E00BG
HLMP-1302#2DD	HLMP-1301-E00DD
HLMP-1302#2VB	HLMP-1301-E00VB
HLMP-1302#S02	HLMP-1301-GH000
HLMP-1305	HLMP-1301-FG000
HLMP-1320#001 ^[2]	HLMP-1320-G0001
HLMP-1320#002 ^[2]	HLMP-1320-G0002
HLMP-1320#010 ^[2]	HLMP-1320-G00A1
HLMP-1320#101 ^[2]	HLMP-1320-G00A2

NOTES

^[1] New Part Added

^[2] Revised

^[3] Omitted From List; Old Part Number To Be Retained

^[4] List Sorted By Old Part Numbers

^[5] This Is The Final Revision For This Part Number Change

HP LED PART-NUMBER CHANGE CROSS-REFERENCE LIST

Revision 2.0^[5] (11 May 1999)

Old Part Number^[4]	New Part Number
HLMP-1320#S02 ^[2]	HLMP-1320-GH000
HLMP-1321	HLMP-1321
HLMP-1321#001	HLMP-1321-G0001
HLMP-1321#002	HLMP-1321-G0002
HLMP-1321#010	HLMP-1321-G00A1
HLMP-1321#101	HLMP-1321-G00A2
HLMP-1321#S02	HLMP-1321-HI000
HLMP-1340	HLMP-1340
HLMP-1340#001	HLMP-1340-J0001
HLMP-1340#002	HLMP-1340-J0002
HLMP-1340#010	HLMP-1340-J00A1
HLMP-1340#101	HLMP-1340-J00A2
HLMP-1340#S02	HLMP-1340-JK000
HLMP-1350	HLMP-1350
HLMP-1350#001	HLMP-1350-C0001
HLMP-1350#002	HLMP-1350-C0002
HLMP-1385	HLMP-1301-G0000
HLMP-1385#001	HLMP-1301-G0001
HLMP-1385#002	HLMP-1301-G0002
HLMP-1385#010	HLMP-1301-G00A1
HLMP-1385#101	HLMP-1301-G00A2
HLMP-1385#ID1	HLMP-1301-G00FG
HLMP-1385#S02	HLMP-1301-GH000
HLMP-1400	HLMP-1401
HLMP-1400#001	HLMP-1401-D0001
HLMP-1400#002	HLMP-1401-D0002
HLMP-1400#010	HLMP-1401-D00A1
HLMP-1400#101	HLMP-1401-D00A2
HLMP-1401	HLMP-1401
HLMP-1401#001	HLMP-1401-D0001
HLMP-1401#002	HLMP-1401-D0002
HLMP-1401#010	HLMP-1401-D00A1
HLMP-1401#101	HLMP-1401-D00A2
HLMP-1401#2DD	HLMP-1401-D00DD
HLMP-1401#S02	HLMP-1401-EF000
HLMP-1402	HLMP-1401
HLMP-1402#001	HLMP-1401-D0001
HLMP-1402#002	HLMP-1401-D0002
HLMP-1402#010	HLMP-1401-D00A1
HLMP-1402#101	HLMP-1401-D00A2
HLMP-1402#2EE	HLMP-1401-D00EE
HLMP-1402#2VB	HLMP-1401-D00VB
HLMP-1402#S02	HLMP-1401-EF000
HLMP-1402#S22	HLMP-1401-EFB00
HLMP-1420	HLMP-1420
HLMP-1420#001	HLMP-1420-F0001
HLMP-1420#002	HLMP-1420-F0002

NOTES

^[1] New Part Added

^[2] Revised

^[3] Omitted From List; Old Part Number To Be Retained

^[4] List Sorted By Old Part Numbers

^[5] This Is The Final Revision For This Part Number Change

HP LED PART-NUMBER CHANGE CROSS-REFERENCE LIST

Revision 2.0^[5] (11 May 1999)

Old Part Number^[4]	New Part Number
HLMP-1420#010	HLMP-1420-F00A1
HLMP-1420#101	HLMP-1420-F00A2
HLMP-1421	HLMP-1421
HLMP-1421#001	HLMP-1421-F0001
HLMP-1421#002	HLMP-1421-F0002
HLMP-1421#010	HLMP-1421-F00A1
HLMP-1421#101	HLMP-1421-F00A2
HLMP-1421#S02	HLMP-1421-FG000
HLMP-1440	HLMP-1440
HLMP-1440#001	HLMP-1440-H0001
HLMP-1440#002	HLMP-1440-H0002
HLMP-1440#010	HLMP-1440-H00A1
HLMP-1440#101	HLMP-1440-H00A2
HLMP-1440#2BJ	HLMP-1440-H00BJ
HLMP-1440#S02	HLMP-1440-HI000
HLMP-1440#S22	HLMP-1440-HIB00
HLMP-1450	HLMP-1450
HLMP-1450#001	HLMP-1450-B0001
HLMP-1450#002	HLMP-1450-B0002
HLMP-1485	HLMP-1401-E0000
HLMP-1485#001	HLMP-1401-E0001
HLMP-1485#002	HLMP-1401-E0002
HLMP-1485#010	HLMP-1401-E00A1
HLMP-1485#101	HLMP-1401-E00A2
HLMP-1485#2DD	HLMP-1401-E00DD
HLMP-1485#ID1	HLMP-1401-E00FG
HLMP-1503	HLMP-1503
HLMP-1503#001	HLMP-1503-C0001
HLMP-1503#002	HLMP-1503-C0002
HLMP-1503#010	HLMP-1503-C00A1
HLMP-1503#101	HLMP-1503-C00A2
HLMP-1503#2DD	HLMP-1503-C00DD
HLMP-1520	HLMP-1520
HLMP-1520#001	HLMP-1520-E0001
HLMP-1520#002	HLMP-1520-E0002
HLMP-1520#010	HLMP-1520-E00A1
HLMP-1520#101	HLMP-1520-E00A2
HLMP-1521	HLMP-1521
HLMP-1521#001	HLMP-1521-E0001
HLMP-1521#002	HLMP-1521-E0002
HLMP-1521#010	HLMP-1521-E00A1
HLMP-1521#101	HLMP-1521-E00A2
HLMP-1521#S02	HLMP-1521-EF000
HLMP-1523	HLMP-1503
HLMP-1523#001	HLMP-1503-C0001
HLMP-1523#002	HLMP-1503-C0002
HLMP-1523#010	HLMP-1503-C00A1
HLMP-1523#101	HLMP-1503-C00A2

NOTES

- ^[1] New Part Added
- ^[2] Revised
- ^[3] Omitted From List; Old Part Number To Be Retained
- ^[4] List Sorted By Old Part Numbers
- ^[5] This Is The Final Revision For This Part Number Change

HP LED PART-NUMBER CHANGE CROSS-REFERENCE LIST

Revision 2.0^[5] (11 May 1999)

Old Part Number^[4]	New Part Number
HLMP-1523#S02	HLMP-1503-DE000
HLMP-1523#S22	HLMP-1503-DED00
HLMP-1540	HLMP-1540
HLMP-1540#001	HLMP-1540-H0001
HLMP-1540#002	HLMP-1540-H0002
HLMP-1540#010	HLMP-1540-H00A1
HLMP-1540#101	HLMP-1540-H00A2
HLMP-1540#2DC	HLMP-1540-H00DC
HLMP-1540#ID2	HLMP-1540-IJ0FH
HLMP-1540#S02	HLMP-1540-IJ000
HLMP-1550	HLMP-1550
HLMP-1550#001	HLMP-1550-A0001
HLMP-1550#002	HLMP-1550-A0002
HLMP-1550#S02	HLMP-1550-BC000
HLMP-1585	HLMP-1503-D0000
HLMP-1585#001	HLMP-1503-D0001
HLMP-1585#002	HLMP-1503-D0002
HLMP-1585#010	HLMP-1503-D00A1
HLMP-1585#101	HLMP-1503-D00A2
HLMP-1585#2BJ	HLMP-1503-D00BJ
HLMP-1585#2DJ	HLMP-1503-D00DJ
HLMP-1585#2EE	HLMP-1503-D00EE
HLMP-1585#ID1	HLMP-1503-D00FG
HLMP-1600	HLMP-1600
HLMP-1600#001	HLMP-1600-D0001
HLMP-1600#002	HLMP-1600-D0002
HLMP-1600#010	HLMP-1600-D00A1
HLMP-1600#101	HLMP-1600-D00A2
HLMP-1601	HLMP-1601
HLMP-1601#001	HLMP-1601-D0001
HLMP-1601#002	HLMP-1601-D0002
HLMP-1601#010	HLMP-1601-D00A1
HLMP-1601#101	HLMP-1601-D00A2
HLMP-1601#S02	HLMP-1601-GH000
HLMP-1620	HLMP-1620
HLMP-1620#001	HLMP-1620-C0001
HLMP-1620#002	HLMP-1620-C0002
HLMP-1620#010	HLMP-1620-C00A1
HLMP-1620#101	HLMP-1620-C00A2
HLMP-1620#S20	HLMP-1620-C0B00
HLMP-1620#S22	HLMP-1620-EFB00
HLMP-1621	HLMP-1621
HLMP-1621#001	HLMP-1621-C0001
HLMP-1621#002	HLMP-1621-C0002
HLMP-1621#010	HLMP-1621-C00A1
HLMP-1621#101	HLMP-1621-C00A2
HLMP-1640	HLMP-1640
HLMP-1640#001	HLMP-1640-B0001

NOTES

- ^[1] New Part Added
- ^[2] Revised
- ^[3] Omitted From List; Old Part Number To Be Retained
- ^[4] List Sorted By Old Part Numbers
- ^[5] This Is The Final Revision For This Part Number Change

HP LED PART-NUMBER CHANGE CROSS-REFERENCE LISTRevision 2.0^[5] (11 May 1999)

Old Part Number^[4]	New Part Number
HLMP-1640#002	HLMP-1640-B0002
HLMP-1640#010	HLMP-1640-B00A1
HLMP-1640#101	HLMP-1640-B00A2
HLMP-1640#S02	HLMP-1640-DE000
HLMP-1640#S20	HLMP-1640-B0D00
HLMP-1641	HLMP-1641
HLMP-1641#001	HLMP-1641-B0001
HLMP-1641#002	HLMP-1641-B0002
HLMP-1641#010	HLMP-1641-B00A1
HLMP-1641#101	HLMP-1641-B00A2
HLMP-1700	HLMP-1700
HLMP-1700#001	HLMP-1700-B0001
HLMP-1700#002	HLMP-1700-B0002
HLMP-1700#010	HLMP-1700-B00A1
HLMP-1700#101	HLMP-1700-B00A2
HLMP-1700#2BH	HLMP-1700-B00BH
HLMP-1700#ID2	HLMP-1700-CD0FH
HLMP-1700#S02	HLMP-1700-CD000
HLMP-1719	HLMP-1719
HLMP-1719#001	HLMP-1719-A0001
HLMP-1719#002	HLMP-1719-A0002
HLMP-1719#010	HLMP-1719-A00A1
HLMP-1719#101	HLMP-1719-A00A2
HLMP-1719#S02	HLMP-1719-AB000
HLMP-1719#S22	HLMP-1719-ABB00
HLMP-1719#STS	HLMP-1719-A00FB
HLMP-1790	HLMP-1790
HLMP-1790#001	HLMP-1790-A0001
HLMP-1790#002	HLMP-1790-A0002
HLMP-1790#010	HLMP-1790-A00A1
HLMP-1790#101	HLMP-1790-A00A2
HLMP-1790#ID2	HLMP-1790-AB0FH
HLMP-1790#S02	HLMP-1790-AB000
HLMP-2300	HLMP-2300
HLMP-2300#S01	HLMP-2300-EE000
HLMP-2300#S02	HLMP-2300-EF000
HLMP-2316	HLMP-2316
HLMP-2316#S02	HLMP-2316-EF000
HLMP-2350	HLMP-2350
HLMP-2350#S02	HLMP-2350-EF000
HLMP-2366	HLMP-2366
HLMP-2400	HLMP-2400
HLMP-2400#S02	HLMP-2400-EF000
HLMP-2400#S22	HLMP-2400-EFB00
HLMP-2404	HLMP-2400-EFB00
HLMP-2416	HLMP-2416
HLMP-2450	HLMP-2450
HLMP-2450#S02	HLMP-2450-EF000

NOTES^[1] New Part Added^[2] Revised^[3] Omitted From List; Old Part Number To Be Retained^[4] List Sorted By Old Part Numbers^[5] This Is The Final Revision For This Part Number Change

HP LED PART-NUMBER CHANGE CROSS-REFERENCE LISTRevision 2.0^[5] (11 May 1999)

Old Part Number^[4]	New Part Number
HLMP-2450#S22	HLMP-2450-EFB00
HLMP-2500	HLMP-2500
HLMP-2500#S02	HLMP-2500-FG000
HLMP-2500#S22	HLMP-2500-FGC00
HLMP-2503	HLMP-2500-FGC00
HLMP-2516	HLMP-2516
HLMP-2550	HLMP-2550
HLMP-2550#S02	HLMP-2550-FG000
HLMP-2550#S22	HLMP-2550-FGC00
HLMP-2566	HLMP-2566
HLMP-2600	HLMP-2600
HLMP-2600#S02	HLMP-2600-EF000
HLMP-2620	HLMP-2620
HLMP-2620#S02	HLMP-2620-EF000
HLMP-2635	HLMP-2635
HLMP-2635#S02	HLMP-2635-EF000
HLMP-2655	HLMP-2655
HLMP-2655#S02	HLMP-2655-EF000
HLMP-2670	HLMP-2670
HLMP-2670#S02	HLMP-2670-EF000
HLMP-2685	HLMP-2685
HLMP-2685#S02	HLMP-2685-EF000
HLMP-2700	HLMP-2700
HLMP-2700#S02	HLMP-2700-EF000
HLMP-2720	HLMP-2720
HLMP-2720#S02	HLMP-2720-EF000
HLMP-2735	HLMP-2735
HLMP-2735#S02	HLMP-2735-EF000
HLMP-2735#S22	HLMP-2735-EFB00
HLMP-2755	HLMP-2755
HLMP-2755#S02	HLMP-2755-EF000
HLMP-2755#S22	HLMP-2755-EFB00
HLMP-2770	HLMP-2770
HLMP-2770#S02	HLMP-2770-EF000
HLMP-2785	HLMP-2785
HLMP-2785#S02	HLMP-2785-EF000
HLMP-2785#S22	HLMP-2785-EFB00
HLMP-2800	HLMP-2800
HLMP-2800#S02	HLMP-2800-FG000
HLMP-2820	HLMP-2820
HLMP-2820#S02	HLMP-2820-FG000
HLMP-2835	HLMP-2835
HLMP-2835#S02	HLMP-2835-FG000
HLMP-2855	HLMP-2855
HLMP-2855#S02	HLMP-2855-FG000
HLMP-2855#S22	HLMP-2855-FGC00
HLMP-2870	HLMP-2870
HLMP-2870#S02	HLMP-2870-FG000

NOTES^[1] New Part Added^[2] Revised^[3] Omitted From List; Old Part Number To Be Retained^[4] List Sorted By Old Part Numbers^[5] This Is The Final Revision For This Part Number Change

HP LED PART-NUMBER CHANGE CROSS-REFERENCE LIST

Revision 2.0^[5] (11 May 1999)

Old Part Number^[4]	New Part Number
HLMP-2885	HLMP-2885
HLMP-2885#S02	HLMP-2885-FG000
HLMP-2885#S22	HLMP-2885-FGC00
HLMP-2950	HLMP-2950
HLMP-2965	HLMP-2965
HLMP-2965#S22	HLMP-2965-FGC00
HLMP-3300	HLMP-3301-D0000
HLMP-3300#001	HLMP-3301-D0001
HLMP-3300#002	HLMP-3301-D0002
HLMP-3300#010	HLMP-3301-D00B2
HLMP-3300#100	HLMP-3301-D00B1
HLMP-3301	HLMP-3301
HLMP-3301#001	HLMP-3301-F0001
HLMP-3301#002	HLMP-3301-F0002
HLMP-3301#010	HLMP-3301-F00B2
HLMP-3301#01S	HLMP-3301-F00FC
HLMP-3301#100	HLMP-3301-F00B1
HLMP-3301#2DD	HLMP-3301-F00DD
HLMP-3301#RR2	HLMP-3301-F00R4
HLMP-3301#S02	HLMP-3301-FG000
HLMP-3315	HLMP-3316
HLMP-3315#002	HLMP-3316-I0002
HLMP-3315#010	HLMP-3316-I00B2
HLMP-3316	HLMP-3316
HLMP-3316#001	HLMP-3316-I0001
HLMP-3316#002	HLMP-3316-I0002
HLMP-3316#010	HLMP-3316-I00B2
HLMP-3316#100	HLMP-3316-I00B1
HLMP-3316#S02	HLMP-3316-IJ000
HLMP-3350	HLMP-3351-D0000
HLMP-3350#001	HLMP-3351-D0001
HLMP-3350#002	HLMP-3351-D0002
HLMP-3351	HLMP-3351
HLMP-3351#001	HLMP-3351-F0001
HLMP-3351#002	HLMP-3351-F0002
HLMP-3351#RL1	HLMP-3351-F00R1
HLMP-3366	HLMP-3366
HLMP-3366#001	HLMP-3366-H0001
HLMP-3366#002	HLMP-3366-H0002
HLMP-3390	HLMP-3390
HLMP-3390#002	HLMP-3390-J0002
HLMP-3400	HLMP-3401
HLMP-3400#001	HLMP-3401-E0001
HLMP-3400#002	HLMP-3401-E0002
HLMP-3400#010	HLMP-3401-E00B2
HLMP-3400#100	HLMP-3401-E00B1
HLMP-3401	HLMP-3401
HLMP-3401#001	HLMP-3401-E0001

NOTES

- ^[1] New Part Added
- ^[2] Revised
- ^[3] Omitted From List; Old Part Number To Be Retained
- ^[4] List Sorted By Old Part Numbers
- ^[5] This Is The Final Revision For This Part Number Change

HP LED PART-NUMBER CHANGE CROSS-REFERENCE LIST

Revision 2.0^[5] (11 May 1999)

Old Part Number^[4]	New Part Number
HLMP-3401#002	HLMP-3401-E0002
HLMP-3401#010	HLMP-3401-E00B2
HLMP-3401#100	HLMP-3401-E00B1
HLMP-3401#S02	HLMP-3401-EF000
HLMP-3401#S22	HLMP-3401-EFB00
HLMP-3402	HLMP-3401-EFB00
HLMP-3415	HLMP-3416
HLMP-3415#002	HLMP-3416-G0002
HLMP-3415#010	HLMP-3416-G00B2
HLMP-3416	HLMP-3416
HLMP-3416#001	HLMP-3416-G0001
HLMP-3416#002	HLMP-3416-G0002
HLMP-3416#010	HLMP-3416-G00B2
HLMP-3416#100	HLMP-3416-G00B1
HLMP-3416#S02	HLMP-3416-IJ000
HLMP-3450	HLMP-3451-D0000
HLMP-3450#002	HLMP-3451-D0002
HLMP-3450#S22	HLMP-3451-EFB00
HLMP-3451	HLMP-3451
HLMP-3451#001	HLMP-3451-F0001
HLMP-3451#002	HLMP-3451-F0002
HLMP-3466	HLMP-3466
HLMP-3466#001	HLMP-3466-F0001
HLMP-3466#002	HLMP-3466-F0002
HLMP-3473	HLMP-3473
HLMP-3490	HLMP-3490
HLMP-3490#002	HLMP-3490-I0002
HLMP-3495	HLMP-3495
HLMP-3495#002	HLMP-3495-I0002
HLMP-3502	HLMP-3507
HLMP-3502#001	HLMP-3507-D0001
HLMP-3502#002	HLMP-3507-D0002
HLMP-3502#010	HLMP-3507-D00B2
HLMP-3502#100	HLMP-3507-D00B1
HLMP-3502#S02	HLMP-3507-EF000
HLMP-3507	HLMP-3507
HLMP-3507#001	HLMP-3507-D0001
HLMP-3507#002	HLMP-3507-D0002
HLMP-3507#010	HLMP-3507-D00B2
HLMP-3507#100	HLMP-3507-D00B1
HLMP-3507#S02	HLMP-3507-EF000
HLMP-3517	HLMP-3519
HLMP-3517#002	HLMP-3519-F0002
HLMP-3517#010	HLMP-3519-F00B2
HLMP-3517#S02	HLMP-3519-IJ000
HLMP-3519	HLMP-3519
HLMP-3519#001	HLMP-3519-F0001
HLMP-3519#002	HLMP-3519-F0002

NOTES

- ^[1] New Part Added
- ^[2] Revised
- ^[3] Omitted From List; Old Part Number To Be Retained
- ^[4] List Sorted By Old Part Numbers
- ^[5] This Is The Final Revision For This Part Number Change

HP LED PART-NUMBER CHANGE CROSS-REFERENCE LIST

Revision 2.0^[5] (11 May 1999)

Old Part Number^[4]	New Part Number
HLMP-3519#010	HLMP-3519-F00B2
HLMP-3519#100	HLMP-3519-F00B1
HLMP-3553	HLMP-3554
HLMP-3553#002	HLMP-3554-E0002
HLMP-3554	HLMP-3554
HLMP-3554#001	HLMP-3554-E0001
HLMP-3554#002	HLMP-3554-E0002
HLMP-3554#RL1	HLMP-3554-E00R1
HLMP-3567	HLMP-3568
HLMP-3568	HLMP-3568
HLMP-3568#001	HLMP-3568-F0001
HLMP-3568#002	HLMP-3568-F0002
HLMP-3590	HLMP-3590
HLMP-3590#002	HLMP-3590-I0002
HLMP-3595	HLMP-3595
HLMP-3595#002	HLMP-3595-I0002
HLMP-3600	HLMP-3600
HLMP-3600#001	HLMP-3600-D0001
HLMP-3600#002	HLMP-3600-D0002
HLMP-3600#010	HLMP-3600-D00B2
HLMP-3600#100	HLMP-3600-D00B1
HLMP-3601	HLMP-3601
HLMP-3601#001	HLMP-3601-D0001
HLMP-3601#002	HLMP-3601-D0002
HLMP-3601#010	HLMP-3601-D00B2
HLMP-3601#100	HLMP-3601-D00B1
HLMP-3602	HLMP-3602
HLMP-3650	HLMP-3650
HLMP-3650#001	HLMP-3650-C0001
HLMP-3650#002	HLMP-3650-C0002
HLMP-3650#010	HLMP-3650-C00B2
HLMP-3650#100	HLMP-3650-C00B1
HLMP-3651	HLMP-3651
HLMP-3651#001	HLMP-3651-C0001
HLMP-3651#002	HLMP-3651-C0002
HLMP-3651#010	HLMP-3651-C00B2
HLMP-3651#100	HLMP-3651-C00B1
HLMP-3680	HLMP-3680
HLMP-3680#001	HLMP-3680-B0001
HLMP-3680#002	HLMP-3680-B0002
HLMP-3680#010	HLMP-3680-B00B2
HLMP-3680#100	HLMP-3680-B00B1
HLMP-3681	HLMP-3681
HLMP-3681#001	HLMP-3681-B0001
HLMP-3681#002	HLMP-3681-B0002
HLMP-3681#010	HLMP-3681-B00B2
HLMP-3681#100	HLMP-3681-B00B1
HLMP-3707	HLMP-3707

NOTES

^[1] New Part Added

^[2] Revised

^[3] Omitted From List; Old Part Number To Be Retained

^[4] List Sorted By Old Part Numbers

^[5] This Is The Final Revision For This Part Number Change

HP LED PART-NUMBER CHANGE CROSS-REFERENCE LIST

Revision 2.0^[5] (11 May 1999)

Old Part Number^[4]	New Part Number
HLMP-3707#002	HLMP-3707-L0002
HLMP-3744	HLMP-3744
HLMP-3744#002	HLMP-3744-L0002
HLMP-3750	HLMP-3750
HLMP-3750#001	HLMP-3750-L0001
HLMP-3750#002	HLMP-3750-L0002
HLMP-3750#010	HLMP-3750-L00B2
HLMP-3750#100	HLMP-3750-L00B1
HLMP-3750#S02	HLMP-3750-LM000
HLMP-3762#001 ^[2]	HLMP-3762-G0001
HLMP-3762#002 ^[2]	HLMP-3762-G0002
HLMP-3762#010 ^[2]	HLMP-3762-G00B2
HLMP-3762#100 ^[2]	HLMP-3762-G00B1
HLMP-3790	HLMP-3790
HLMP-3807	HLMP-3807
HLMP-3807#002	HLMP-3807-K0002
HLMP-3850	HLMP-3850
HLMP-3850#001	HLMP-3850-K0001
HLMP-3850#002	HLMP-3850-K0002
HLMP-3850#010	HLMP-3850-K00B2
HLMP-3850#100	HLMP-3850-K00B1
HLMP-3850#S02	HLMP-3850-KL000
HLMP-3850#S22	HLMP-3850-KLB00
HLMP-3862	HLMP-3862
HLMP-3862#001	HLMP-3862-F0001
HLMP-3862#002	HLMP-3862-F0002
HLMP-3862#010	HLMP-3862-F00B2
HLMP-3862#100	HLMP-3862-F00B1
HLMP-3862#S22	HLMP-3862-FGB00
HLMP-3907	HLMP-3907
HLMP-3907#002	HLMP-3907-K0002
HLMP-3914	HLMP-3914
HLMP-3914#001	HLMP-3914-K0001
HLMP-3914#002	HLMP-3914-K0002
HLMP-3914#010	HLMP-3914-K00B2
HLMP-3914#100	HLMP-3914-K00B1
HLMP-3950	HLMP-3950
HLMP-3950#001	HLMP-3950-K0001
HLMP-3950#002	HLMP-3950-K0002
HLMP-3950#010	HLMP-3950-K00B2
HLMP-3950#100	HLMP-3950-K00B1
HLMP-3950#S02	HLMP-3950-LM000
HLMP-3960	HLMP-3960
HLMP-3960#001	HLMP-3960-K0001
HLMP-3960#002	HLMP-3960-K0002
HLMP-3960#S02	HLMP-3960-LM000
HLMP-3962#001 ^[2]	HLMP-3962-F0001

NOTES

^[1] New Part Added

^[2] Revised

^[3] Omitted From List; Old Part Number To Be Retained

^[4] List Sorted By Old Part Numbers

^[5] This Is The Final Revision For This Part Number Change

HP LED PART-NUMBER CHANGE CROSS-REFERENCE LIST

Revision 2.0^[5] (11 May 1999)

Old Part Number^[4]	New Part Number
HLMP-3962#002 ^[2]	HLMP-3962-F0002
HLMP-3962#010 ^[2]	HLMP-3962-F00B2
HLMP-3962#100 ^[2]	HLMP-3962-F00B1
HLMP-4100	HLMP-4101
HLMP-4101	HLMP-4101
HLMP-4101#S02	HLMP-4101-ST000
HLMP-4700	HLMP-4700
HLMP-4700#001	HLMP-4700-C0001
HLMP-4700#002	HLMP-4700-C0002
HLMP-4700#010	HLMP-4700-C00B2
HLMP-4700#ID2	HLMP-4700-CD0FH
HLMP-4700#S02	HLMP-4700-CD000
HLMP-4719	HLMP-4719
HLMP-4719#001	HLMP-4719-A0001
HLMP-4719#002	HLMP-4719-A0002
HLMP-4719#010	HLMP-4719-A00B2
HLMP-4719#100	HLMP-4719-A00B1
HLMP-4719#S02	HLMP-4719-BC000
HLMP-4719#S22	HLMP-4719-BCB00
HLMP-4740	HLMP-4740
HLMP-4740#001	HLMP-4740-A0001
HLMP-4740#002	HLMP-4740-A0002
HLMP-4740#010	HLMP-4740-A00B2
HLMP-4740#100	HLMP-4740-A00B1
HLMP-4740#RL1	HLMP-4740-A00R1
HLMP-4740#S02	HLMP-4740-AB000
HLMP-6000	HLMP-6000
HLMP-6000#010	HLMP-6000-E0010
HLMP-6000#011	HLMP-6000-E0011
HLMP-6000#012	HLMP-6000-E0012
HLMP-6000#021	HLMP-6000-E0021
HLMP-6000#022	HLMP-6000-E0022
HLMP-6000#031	HLMP-6000-E0031
HLMP-6000#1L1	HLMP-6000-E001L
HLMP-6000#1S1	HLMP-6000-E001S
HLMP-6001	HLMP-6000-G0000
HLMP-6001#010	HLMP-6000-G0010
HLMP-6001#011	HLMP-6000-G0011
HLMP-6001#012	HLMP-6000-G0012
HLMP-6001#021	HLMP-6000-G0021
HLMP-6001#031	HLMP-6000-G0031
HLMP-6001#032	HLMP-6000-G0032
HLMP-6001#1L1	HLMP-6000-G001L
HLMP-6001#1S1	HLMP-6000-G001S
HLMP-6001#2S1	HLMP-6000-G002S
HLMP-6300	HLMP-6300
HLMP-6300#010	HLMP-6300-F0010

NOTES

^[1] New Part Added

^[2] Revised

^[3] Omitted From List; Old Part Number To Be Retained

^[4] List Sorted By Old Part Numbers

^[5] This Is The Final Revision For This Part Number Change

HP LED PART-NUMBER CHANGE CROSS-REFERENCE LIST

Revision 2.0^[5] (11 May 1999)

Old Part Number^[4]	New Part Number
HLMP-6300#011	HLMP-6300-F0011
HLMP-6300#012	HLMP-6300-F0012
HLMP-6300#021	HLMP-6300-F0021
HLMP-6300#022	HLMP-6300-F0022
HLMP-6300#024	HLMP-6300-F0024
HLMP-6300#031	HLMP-6300-F0031
HLMP-6300#032	HLMP-6300-F0032
HLMP-6300#034	HLMP-6300-F0034
HLMP-6300#1L1	HLMP-6300-F001L
HLMP-6300#1S1	HLMP-6300-F001S
HLMP-6300#2L1	HLMP-6300-F002L
HLMP-6300#2S1	HLMP-6300-F002S
HLMP-6300#S02	HLMP-6300-KL000
HLMP-6305	HLMP-6305
HLMP-6305#010 ^[2]	HLMP-6305-L0010
HLMP-6305#011 ^[2]	HLMP-6305-L0011
HLMP-6305#012 ^[2]	HLMP-6305-L0012
HLMP-6305#021 ^[2]	HLMP-6305-L0021
HLMP-6305#022 ^[2]	HLMP-6305-L0022
HLMP-6305#031 ^[2]	HLMP-6305-L0031
HLMP-6305#032 ^[2]	HLMP-6305-L0032
HLMP-6305#1L1 ^[2]	HLMP-6305-L001L
HLMP-6305#1S1 ^[2]	HLMP-6305-L001S
HLMP-6400	HLMP-6400
HLMP-6400#010	HLMP-6400-F0010
HLMP-6400#011	HLMP-6400-F0011
HLMP-6400#012	HLMP-6400-F0012
HLMP-6400#021	HLMP-6400-F0021
HLMP-6400#022	HLMP-6400-F0022
HLMP-6400#024	HLMP-6400-F0024
HLMP-6400#031	HLMP-6400-F0031
HLMP-6400#032	HLMP-6400-F0032
HLMP-6400#034	HLMP-6400-F0034
HLMP-6400#1L1	HLMP-6400-F001L
HLMP-6400#1S1	HLMP-6400-F001S
HLMP-6400#2L1	HLMP-6400-F002L
HLMP-6400#2S1	HLMP-6400-F002S
HLMP-6400#S02	HLMP-6400-JK000
HLMP-6405	HLMP-6405
HLMP-6405#010	HLMP-6405-J0010
HLMP-6405#011	HLMP-6405-J0011
HLMP-6405#012	HLMP-6405-J0012
HLMP-6405#021	HLMP-6405-J0021
HLMP-6405#022	HLMP-6405-J0022
HLMP-6405#031	HLMP-6405-J0031
HLMP-6405#032	HLMP-6405-J0032

NOTES

^[1] New Part Added

^[2] Revised

^[3] Omitted From List; Old Part Number To Be Retained

^[4] List Sorted By Old Part Numbers

^[5] This Is The Final Revision For This Part Number Change

HP LED PART-NUMBER CHANGE CROSS-REFERENCE LIST

Revision 2.0^[5] (11 May 1999)

Old Part Number^[4]	New Part Number
HLMP-6405#1L1	HLMP-6405-J001L
HLMP-6405#1S1	HLMP-6405-J001S
HLMP-6405#2S1	HLMP-6405-J002S
HLMP-6405#S02	HLMP-6405-MN000
HLMP-6500	HLMP-6500
HLMP-6500#010	HLMP-6500-F0010
HLMP-6500#011	HLMP-6500-F0011
HLMP-6500#012	HLMP-6500-F0012
HLMP-6500#021	HLMP-6500-F0021
HLMP-6500#022	HLMP-6500-F0022
HLMP-6500#024	HLMP-6500-F0024
HLMP-6500#031	HLMP-6500-F0031
HLMP-6500#032	HLMP-6500-F0032
HLMP-6500#034	HLMP-6500-F0034
HLMP-6500#1L1	HLMP-6500-F001L
HLMP-6500#1S1	HLMP-6500-F001S
HLMP-6500#2S1	HLMP-6500-F002S
HLMP-6500#S02	HLMP-6500-JK000
HLMP-6505	HLMP-6505
HLMP-6505#010 ^[2]	HLMP-6505-L0010
HLMP-6505#011 ^[2]	HLMP-6505-L0011
HLMP-6505#012 ^[2]	HLMP-6505-L0012
HLMP-6505#021 ^[2]	HLMP-6505-L0021
HLMP-6505#022 ^[2]	HLMP-6505-L0022
HLMP-6505#031 ^[2]	HLMP-6505-L0031
HLMP-6505#032 ^[2]	HLMP-6505-L0032
HLMP-6505#1L1 ^[2]	HLMP-6505-L001L
HLMP-6505#1S1 ^[2]	HLMP-6505-L001S
HLMP-6505#2S1 ^[2]	HLMP-6505-L002S
HLMP-6505#S02	HLMP-6505-NP000
HLMP-6600	HLMP-6600
HLMP-6600#010	HLMP-6600-G0010
HLMP-6600#011	HLMP-6600-G0011
HLMP-6600#012	HLMP-6600-G0012
HLMP-6600#1L1	HLMP-6600-G001L
HLMP-6620	HLMP-6620
HLMP-6620#010	HLMP-6620-F0010
HLMP-6620#011	HLMP-6620-F0011
HLMP-6620#012	HLMP-6620-F0012
HLMP-6620#021	HLMP-6620-F0021
HLMP-6620#031	HLMP-6620-F0031
HLMP-6620#032	HLMP-6620-F0032
HLMP-6620#1L1	HLMP-6620-F001L
HLMP-6620#1S1	HLMP-6620-F001S
HLMP-6620#2L1	HLMP-6620-F002L
HLMP-6620#2S1	HLMP-6620-F002S

NOTES

^[1] New Part Added

^[2] Revised

^[3] Omitted From List; Old Part Number To Be Retained

^[4] List Sorted By Old Part Numbers

^[5] This Is The Final Revision For This Part Number Change

HP LED PART-NUMBER CHANGE CROSS-REFERENCE LIST

Revision 2.0^[5] (11 May 1999)

Old Part Number^[4]	New Part Number
HLMP-6700	HLMP-6700
HLMP-6700#010	HLMP-6700-G0010
HLMP-6700#011	HLMP-6700-G0011
HLMP-6700#012	HLMP-6700-G0012
HLMP-6700#031	HLMP-6700-G0031
HLMP-6700#1L1	HLMP-6700-G001L
HLMP-6700#1S1	HLMP-6700-G001S
HLMP-6700#2S1	HLMP-6700-G002S
HLMP-6720	HLMP-6720
HLMP-6720#010	HLMP-6720-F0010
HLMP-6720#011	HLMP-6720-F0011
HLMP-6720#012	HLMP-6720-F0012
HLMP-6720#021	HLMP-6720-F0021
HLMP-6720#031	HLMP-6720-F0031
HLMP-6720#1L1	HLMP-6720-F001L
HLMP-6720#1S1	HLMP-6720-F001S
HLMP-6720#2S1	HLMP-6720-F002S
HLMP-6800	HLMP-6800
HLMP-6800#010	HLMP-6800-G0010
HLMP-6800#011	HLMP-6800-G0011
HLMP-6800#012	HLMP-6800-G0012
HLMP-6800#021	HLMP-6800-G0021
HLMP-6800#022	HLMP-6800-G0022
HLMP-6800#031	HLMP-6800-G0031
HLMP-6800#1L1	HLMP-6800-G001L
HLMP-6800#1S1	HLMP-6800-G001S
HLMP-6800#2S1	HLMP-6800-G002S
HLMP-6820	HLMP-6820
HLMP-6820#010	HLMP-6820-F0010
HLMP-6820#011	HLMP-6820-F0011
HLMP-6820#012	HLMP-6820-F0012
HLMP-6820#021	HLMP-6820-F0021
HLMP-6820#022	HLMP-6820-F0022
HLMP-6820#032	HLMP-6820-F0032
HLMP-6820#1L1	HLMP-6820-F001L
HLMP-6820#1S1	HLMP-6820-F001S
HLMP-6820#2S1	HLMP-6820-F002S
HLMP-7000	HLMP-7000
HLMP-7000#010	HLMP-7000-D0010
HLMP-7000#011	HLMP-7000-D0011
HLMP-7000#012	HLMP-7000-D0012
HLMP-7000#021	HLMP-7000-D0021
HLMP-7000#022	HLMP-7000-D0022
HLMP-7000#031	HLMP-7000-D0031
HLMP-7000#032	HLMP-7000-D0032
HLMP-7000#1L1	HLMP-7000-D001L
HLMP-7000#1S1	HLMP-7000-D001S
HLMP-7000#2S1	HLMP-7000-D002S

NOTES

- ^[1] New Part Added
- ^[2] Revised
- ^[3] Omitted From List; Old Part Number To Be Retained
- ^[4] List Sorted By Old Part Numbers
- ^[5] This Is The Final Revision For This Part Number Change

HP LED PART-NUMBER CHANGE CROSS-REFERENCE LIST

Revision 2.0^[5] (11 May 1999)

Old Part Number^[4]	New Part Number
HLMP-7019	HLMP-7019
HLMP-7019#010	HLMP-7019-D0010
HLMP-7019#011	HLMP-7019-D0011
HLMP-7019#012	HLMP-7019-D0012
HLMP-7019#021	HLMP-7019-D0021
HLMP-7019#022	HLMP-7019-D0022
HLMP-7019#031	HLMP-7019-D0031
HLMP-7019#032	HLMP-7019-D0032
HLMP-7019#1L1	HLMP-7019-D001L
HLMP-7019#1S1	HLMP-7019-D001S
HLMP-7040	HLMP-7040
HLMP-7040#010	HLMP-7040-D0010
HLMP-7040#011	HLMP-7040-D0011
HLMP-7040#012	HLMP-7040-D0012
HLMP-7040#021	HLMP-7040-D0021
HLMP-7040#022	HLMP-7040-D0022
HLMP-7040#031	HLMP-7040-D0031
HLMP-7040#032	HLMP-7040-D0032
HLMP-7040#1L1	HLMP-7040-D001L
HLMP-7040#1S1	HLMP-7040-D001S
HLMP-7040#2L1	HLMP-7040-D002L
HLMP-7040#2S1	HLMP-7040-D002S
HLMP-C105	HLMP-C105
HLMP-C115	HLMP-C115
HLMP-C115#001	HLMP-C115-O0001
HLMP-C115#002	HLMP-C115-O0002
HLMP-C115#S02	HLMP-C115-OP000
HLMP-C116	HLMP-C116
HLMP-C116#001	HLMP-C116-P0001
HLMP-C116#002	HLMP-C116-P0002
HLMP-C117	HLMP-C117
HLMP-C117#S02	HLMP-C117-OP000
HLMP-C123	HLMP-C123
HLMP-C123#001	HLMP-C123-L0001
HLMP-C123#002	HLMP-C123-L0002
HLMP-C124	HLMP-C124
HLMP-C124#001	HLMP-C124-O0001
HLMP-C124#002	HLMP-C124-O0002
HLMP-C124#S02	HLMP-C124-PQ000
HLMP-C215	HLMP-C215
HLMP-C215#001	HLMP-C215-M0001
HLMP-C215#002	HLMP-C215-M0002
HLMP-C215#010	HLMP-C215-M00B2
HLMP-C215#S02	HLMP-C215-MN000
HLMP-C223	HLMP-C223
HLMP-C223#001	HLMP-C223-L0001
HLMP-C223#002	HLMP-C223-L0002
HLMP-C223#S02	HLMP-C223-MN000

NOTES

^[1] New Part Added

^[2] Revised

^[3] Omitted From List; Old Part Number To Be Retained

^[4] List Sorted By Old Part Numbers

^[5] This Is The Final Revision For This Part Number Change

HP LED PART-NUMBER CHANGE CROSS-REFERENCE LIST

Revision 2.0^[5] (11 May 1999)

Old Part Number^[4]	New Part Number
HLMP-C315	HLMP-C315
HLMP-C315#001	HLMP-C315-L0001
HLMP-C315#002	HLMP-C315-L0002
HLMP-C315#010	HLMP-C315-L00B2
HLMP-C315#S02	HLMP-C315-LM000
HLMP-C323	HLMP-C323
HLMP-C323#001	HLMP-C323-K0001
HLMP-C323#002	HLMP-C323-K0002
HLMP-C323#S02	HLMP-C323-KL000
HLMP-C415	HLMP-C415
HLMP-C415#001	HLMP-C415-M0001
HLMP-C415#002	HLMP-C415-M0002
HLMP-C415#S02	HLMP-C415-MN000
HLMP-C423	HLMP-C423
HLMP-C423#001	HLMP-C423-L0001
HLMP-C423#002	HLMP-C423-L0002
HLMP-C423#S02	HLMP-C423-LM000
HLMP-C515	HLMP-C515
HLMP-C515#001	HLMP-C515-L0001
HLMP-C515#002	HLMP-C515-L0002
HLMP-C515#010	HLMP-C515-L00B2
HLMP-C515#S02	HLMP-C515-LM000
HLMP-C523	HLMP-C523
HLMP-C523#001	HLMP-C523-J0001
HLMP-C523#002	HLMP-C523-J0002
HLMP-C523#010 ^[1]	HLMP-C523-J00B2
HLMP-C523#2UQ	HLMP-C523-J00UQ
HLMP-C523#S02	HLMP-C523-KL000
HLMP-C615	HLMP-C615
HLMP-C615#001	HLMP-C615-G0001
HLMP-C615#002	HLMP-C615-G0002
HLMP-C623	HLMP-C623
HLMP-C623#001	HLMP-C623-E0001
HLMP-C623#002	HLMP-C623-E0002
HLMP-D101	HLMP-D101
HLMP-D101#001	HLMP-D101-J0001
HLMP-D101#002	HLMP-D101-J0002
HLMP-D101#010	HLMP-D101-J00B2
HLMP-D101#100	HLMP-D101-J00B1
HLMP-D101#S02	HLMP-D101-JK000
HLMP-D105	HLMP-D105
HLMP-D105#001	HLMP-D105-M0001
HLMP-D105#002	HLMP-D105-M0002
HLMP-D105#010	HLMP-D105-M00B2
HLMP-D105#100	HLMP-D105-M00B1
HLMP-D105#S02	HLMP-D105-NO000
HLMP-D150	HLMP-D150

NOTES

- ^[1] New Part Added
- ^[2] Revised
- ^[3] Omitted From List; Old Part Number To Be Retained
- ^[4] List Sorted By Old Part Numbers
- ^[5] This Is The Final Revision For This Part Number Change

HP LED PART-NUMBER CHANGE CROSS-REFERENCE LIST

Revision 2.0^[5] (11 May 1999)

Old Part Number^[4]	New Part Number
HLMP-D150#001	HLMP-D150-C0001
HLMP-D150#002	HLMP-D150-C0002
HLMP-D150#010	HLMP-D150-C00B2
HLMP-D150#100	HLMP-D150-C00B1
HLMP-D150#S02	HLMP-D150-CD000
HLMP-D155	HLMP-D155
HLMP-D155#001	HLMP-D155-F0001
HLMP-D155#002	HLMP-D155-F0002
HLMP-D155#010	HLMP-D155-F00B2
HLMP-D155#100	HLMP-D155-F00B1
HLMP-D400	HLMP-D401-D0000
HLMP-D400#002	HLMP-D401-D0002
HLMP-D400#010	HLMP-D401-D00B2
HLMP-D400#100	HLMP-D401-D00B1
HLMP-D401	HLMP-D401
HLMP-D401#001	HLMP-D401-F0001
HLMP-D401#002	HLMP-D401-F0002
HLMP-D401#010	HLMP-D401-F00B2
HLMP-D401#100	HLMP-D401-F00B1
HLMP-D401#1D2	HLMP-D401-EF0FH
HLMP-D401#S02	HLMP-D401-EF000
HLMP-D402	HLMP-D401-D0000
HLMP-D640	HLMP-D640
HLMP-D640#002	HLMP-D640-E0002
HLMP-D640#2DG	HLMP-D640-E00DG
HLMP-DD16	HLMP-ED16-TW000
HLMP-DD16	HLMP-ED16-TW000
HLMP-DD18	HLMP-ED18-TW000
HLMP-DD18	HLMP-ED18-TW000
HLMP-DD25	HLMP-ED25-QT000
HLMP-DD25	HLMP-ED25-QT000
HLMP-DD27	HLMP-ED27-QT000
HLMP-DD27	HLMP-ED27-QT000
HLMP-DD31	HLMP-ED31-PS000
HLMP-DD31	HLMP-ED31-PS000
HLMP-DD33	HLMP-ED33-PS000
HLMP-DD33	HLMP-ED33-PS000
HLMP-DG08	HLMP-EG08-UX000
HLMP-DG08	HLMP-EG08-UX000
HLMP-DG10	HLMP-EG10-UX000
HLMP-DG10	HLMP-EG10-UX000
HLMP-DG15	HLMP-EG15-RU000
HLMP-DG15	HLMP-EG15-RU000
HLMP-DG17	HLMP-EG17-RU000
HLMP-DG17	HLMP-EG17-RU000
HLMP-DG24	HLMP-EG24-PS000
HLMP-DG24	HLMP-EG24-PS000
HLMP-DG26	HLMP-EG26-PS000

NOTES

- ^[1] New Part Added
- ^[2] Revised
- ^[3] Omitted From List; Old Part Number To Be Retained
- ^[4] List Sorted By Old Part Numbers
- ^[5] This Is The Final Revision For This Part Number Change

HP LED PART-NUMBER CHANGE CROSS-REFERENCE LIST

Revision 2.0^[5] (11 May 1999)

Old Part Number^[4]	New Part Number
HLMP-DG26	HLMP-EG26-PS000
HLMP-DG30	HLMP-EG30-MQ000
HLMP-DG30	HLMP-EG30-MQ000
HLMP-DG32	HLMP-EG30-MQ000
HLMP-DG32	HLMP-EG30-MQ000
HLMP-DH08	HLMP-EH08-UX000
HLMP-DH08	HLMP-EH08-UX000
HLMP-DH10	HLMP-EH10-UX000
HLMP-DH10	HLMP-EH10-UX000
HLMP-DH15	HLMP-EH15-RU000
HLMP-DH15	HLMP-EH15-RU000
HLMP-DH16	HLMP-EH16-TW000
HLMP-DH16	HLMP-EH16-TW000
HLMP-DH17	HLMP-EH17-RU000
HLMP-DH17	HLMP-EH17-RU000
HLMP-DH18	HLMP-EH18-TW000
HLMP-DH18	HLMP-EH18-TW000
HLMP-DH24	HLMP-EH24-PS000
HLMP-DH24	HLMP-EH24-PS000
HLMP-DH25	HLMP-EH25-QT000
HLMP-DH25	HLMP-EH25-QT000
HLMP-DH26	HLMP-EH26-PS000
HLMP-DH26	HLMP-EH26-PS000
HLMP-DH27	HLMP-EH27-QT000
HLMP-DH27	HLMP-EH27-QT000
HLMP-DH30	HLMP-EH30-MQ000
HLMP-DH30	HLMP-EH30-MQ000
HLMP-DH31	HLMP-EH31-PS000
HLMP-DH31	HLMP-EH31-PS000
HLMP-DH32	HLMP-EH32-MQ000
HLMP-DH32	HLMP-EH32-MQ000
HLMP-DH33	HLMP-EH33-PS000
HLMP-DH33	HLMP-EH33-PS000
HLMP-DJ08	HLMP-EJ08-WZ000
HLMP-DJ08	HLMP-EJ08-WZ000
HLMP-DJ10	HLMP-EJ10-WZ000
HLMP-DJ10	HLMP-EJ10-WZ000
HLMP-DJ15	HLMP-EJ15-RU000
HLMP-DJ15	HLMP-EJ15-RU000
HLMP-DJ17	HLMP-EJ17-RU000
HLMP-DJ17	HLMP-EJ17-RU000
HLMP-DJ24	HLMP-EJ24-QT000
HLMP-DJ24	HLMP-EJ24-QT000
HLMP-DJ26	HLMP-EJ26-QT000
HLMP-DJ26	HLMP-EJ26-QT000
HLMP-DJ30	HLMP-EJ30-PS000
HLMP-DJ30	HLMP-EJ30-PS000
HLMP-DJ32	HLMP-EJ32-PS000

NOTES

^[1] New Part Added

^[2] Revised

^[3] Omitted From List; Old Part Number To Be Retained

^[4] List Sorted By Old Part Numbers

^[5] This Is The Final Revision For This Part Number Change

HP LED PART-NUMBER CHANGE CROSS-REFERENCE LIST

Revision 2.0^[5] (11 May 1999)

Old Part Number^[4]	New Part Number
HLMP-DJ32	HLMP-EJ32-PS000
HLMP-DL08	HLMP-EL08-VY000
HLMP-DL08	HLMP-EL08-VY000
HLMP-DL10	HLMP-EL10-VY000
HLMP-DL10	HLMP-EL10-VY000
HLMP-DL15	HLMP-EL15-SV000
HLMP-DL15	HLMP-EL15-SV000
HLMP-DL16	HLMP-EL16-UX000
HLMP-DL16	HLMP-EL16-UX000
HLMP-DL17	HLMP-EL17-SV000
HLMP-DL17	HLMP-EL17-SV000
HLMP-DL18	HLMP-EL18-UX000
HLMP-DL18	HLMP-EL18-UX000
HLMP-DL24	HLMP-EL25-QT000 or HLMP-EL24-PS000
HLMP-DL24	HLMP-EL25-QT000 or HLMP-EL24-PS000
HLMP-DL25	HLMP-EL25-SV000
HLMP-DL25	HLMP-EL25-SV000
HLMP-DL26	HLMP-EL27-QT000 or HLMP-EL26-PS000
HLMP-DL26	HLMP-EL27-QT000 or HLMP-EL26-PS000
HLMP-DL27	HLMP-EL27-SV000
HLMP-DL27	HLMP-EL27-SV000
HLMP-DL30	HLMP-EL30-PS000
HLMP-DL30	HLMP-EL30-PS000
HLMP-DL31	HLMP-EL31-QT000
HLMP-DL31	HLMP-EL31-QT000
HLMP-DL32	HLMP-EL32-PS000
HLMP-DL32	HLMP-EL32-PS000
HLMP-DL33	HLMP-EL31-QT000
HLMP-DL33	HLMP-EL31-QT000
HLMP-K101	HLMP-K101
HLMP-K101#001	HLMP-K101-I0001
HLMP-K101#002	HLMP-K101-I0002
HLMP-K101#010	HLMP-K101-I00A1
HLMP-K101#101	HLMP-K101-I00A2
HLMP-K101#ID2	HLMP-K101-IJ0FH
HLMP-K101#S02	HLMP-K101-IJ000
HLMP-K105	HLMP-K105
HLMP-K105#001	HLMP-K105-J0001
HLMP-K105#002	HLMP-K105-J0002
HLMP-K105#010	HLMP-K105-J00A1
HLMP-K105#101	HLMP-K105-J00A2
HLMP-K105#S02	HLMP-K105-KL000
HLMP-K150	HLMP-K150
HLMP-K150#001	HLMP-K150-C0001
HLMP-K150#002	HLMP-K150-C0002
HLMP-K150#010	HLMP-K150-C00A1
HLMP-K150#101	HLMP-K150-C00A2
HLMP-K150#2DH	HLMP-K150-C00DH

NOTES

^[1] New Part Added

^[2] Revised

^[3] Omitted From List; Old Part Number To Be Retained

^[4] List Sorted By Old Part Numbers

^[5] This Is The Final Revision For This Part Number Change

HP LED PART-NUMBER CHANGE CROSS-REFERENCE LIST

Revision 2.0^[5] (11 May 1999)

Old Part Number ^[4]	New Part Number
HLMP-K150#S02	HLMP-K150-CD000
HLMP-K155	HLMP-K155
HLMP-K155#001	HLMP-K155-D0001
HLMP-K155#002	HLMP-K155-D0002
HLMP-K155#010	HLMP-K155-D00A1
HLMP-K155#101	HLMP-K155-D00A2
HLMP-K155#2DD	HLMP-K155-D00DD
HLMP-K155#S02	HLMP-K155-DE000
HLMP-K400#S22	HLMP-K401-FGD00
HLMP-K401	HLMP-K401
HLMP-K401#001	HLMP-K401-E0001
HLMP-K401#002	HLMP-K401-E0002
HLMP-K401#010	HLMP-K401-E00A1
HLMP-K401#101	HLMP-K401-E00A2
HLMP-K402	HLMP-K401
HLMP-K402#2EE	HLMP-K401-E00EE
HLMP-K402#S02	HLMP-K401-EF000
HLMP-K440	HLMP-K440
HLMP-K600	HLMP-K600
HLMP-K640	HLMP-K640
HLMP-K640#002	HLMP-K640-D0002
HLMP-K640#101	HLMP-K640-D00A2
HLMP-K640#2EG	HLMP-K640-D00EG
HLMP-K640#S22	HLMP-K640-FGN00
HLMP-KE50	HLMP-KE50
HLMP-P002	HLMP-P002
HLMP-P005	HLMP-P005
HLMP-P005#011	HLMP-P005-F0011
HLMP-P005#012	HLMP-P005-F0012
HLMP-P005#021	HLMP-P005-F0021
HLMP-P005#031	HLMP-P005-F0031
HLMP-P102	HLMP-P102
HLMP-P102#032	HLMP-P102-F0032
HLMP-P105	HLMP-P105
HLMP-P105#011	HLMP-P105-L0011
HLMP-P105#012	HLMP-P105-L0012
HLMP-P105#021	HLMP-P105-L0021
HLMP-P105#022	HLMP-P105-L0022
HLMP-P105#031	HLMP-P105-L0031
HLMP-P105#032	HLMP-P105-L0032
HLMP-P105#1L1	HLMP-P105-L001L
HLMP-P105#1S1	HLMP-P105-L001S
HLMP-P105#2L1	HLMP-P105-L002L
HLMP-P105#2S1	HLMP-P105-L002S
HLMP-P105#S02	HLMP-P105-NP000
HLMP-P106	HLMP-P106
HLMP-P106#011 ^[2]	HLMP-P106-Q0011

NOTES

^[1] New Part Added

^[2] Revised

^[3] Omitted From List; Old Part Number To Be Retained

^[4] List Sorted By Old Part Numbers

^[5] This Is The Final Revision For This Part Number Change

HP LED PART-NUMBER CHANGE CROSS-REFERENCE LIST

Revision 2.0^[5] (11 May 1999)

Old Part Number^[4]	New Part Number
HLMP-P106#012 ^[2]	HLMP-P106-Q0012
HLMP-P106#021 ^[2]	HLMP-P106-Q0021
HLMP-P106#031 ^[2]	HLMP-P106-Q0031
HLMP-P106#1S1 ^[2]	HLMP-P106-Q001S
HLMP-P156	HLMP-P156
HLMP-P156#011	HLMP-P156-EG011
HLMP-P156#031	HLMP-P156-EG031
HLMP-P202	HLMP-P202
HLMP-P202#011	HLMP-P202-F0011
HLMP-P202#012	HLMP-P202-F0012
HLMP-P202#021	HLMP-P202-F0021
HLMP-P202#022	HLMP-P202-F0022
HLMP-P202#031	HLMP-P202-F0031
HLMP-P202#032	HLMP-P202-F0032
HLMP-P202#1S1	HLMP-P202-F001S
HLMP-P205	HLMP-P205
HLMP-P205#010	HLMP-P205-F0010
HLMP-P205#011	HLMP-P205-F0011
HLMP-P205#012	HLMP-P205-F0012
HLMP-P205#021	HLMP-P205-F0021
HLMP-P205#022	HLMP-P205-F0022
HLMP-P205#031	HLMP-P205-F0031
HLMP-P205#032	HLMP-P205-F0032
HLMP-P205#1L1	HLMP-P205-F001L
HLMP-P205#1S1	HLMP-P205-F001S
HLMP-P205#2S1	HLMP-P205-F002S
HLMP-P205#S02	HLMP-P205-JK000
HLMP-P302	HLMP-P302
HLMP-P302#012	HLMP-P302-F0012
HLMP-P302#021	HLMP-P302-F0021
HLMP-P302#031	HLMP-P302-F0031
HLMP-P302#032	HLMP-P302-F0032
HLMP-P302#1S1	HLMP-P302-F001S
HLMP-P302#2S1	HLMP-P302-F002S
HLMP-P305	HLMP-P305
HLMP-P305#010	HLMP-P305-F0010
HLMP-P305#011	HLMP-P305-F0011
HLMP-P305#012	HLMP-P305-F0012
HLMP-P305#021	HLMP-P305-F0021
HLMP-P305#022	HLMP-P305-F0022
HLMP-P305#031	HLMP-P305-F0031
HLMP-P305#032	HLMP-P305-F0032
HLMP-P305#1L1	HLMP-P305-F001L
HLMP-P305#1S1	HLMP-P305-F001S
HLMP-P305#2S1	HLMP-P305-F002S
HLMP-P402	HLMP-P402
HLMP-P402#022	HLMP-P402-F0022

NOTES

^[1] New Part Added

^[2] Revised

^[3] Omitted From List; Old Part Number To Be Retained

^[4] List Sorted By Old Part Numbers

^[5] This Is The Final Revision For This Part Number Change

HP LED PART-NUMBER CHANGE CROSS-REFERENCE LIST

Revision 2.0^[5] (11 May 1999)

Old Part Number^[4]	New Part Number
HLMP-P405	HLMP-P405
HLMP-P405#011	HLMP-P405-F0011
HLMP-P405#012	HLMP-P405-F0012
HLMP-P405#021	HLMP-P405-F0021
HLMP-P405#022	HLMP-P405-F0022
HLMP-P405#031	HLMP-P405-F0031
HLMP-P405#032	HLMP-P405-F0032
HLMP-P405#1L1	HLMP-P405-F001L
HLMP-P405#1S1	HLMP-P405-F001S
HLMP-P405#2L1	HLMP-P405-F002L
HLMP-P405#2S1	HLMP-P405-F002S
HLMP-P405#S02	HLMP-P405-JK000
HLMP-P502	HLMP-P502
HLMP-P502#011	HLMP-P502-F0011
HLMP-P502#012	HLMP-P502-F0012
HLMP-P502#021	HLMP-P502-F0021
HLMP-P502#022	HLMP-P502-F0022
HLMP-P502#031	HLMP-P502-F0031
HLMP-P502#032	HLMP-P502-F0032
HLMP-P502#1L1	HLMP-P502-F001L
HLMP-P502#1S1	HLMP-P502-F001S
HLMP-P505	HLMP-P505
HLMP-P505#010 ^[2]	HLMP-P505-G0010
HLMP-P505#011 ^[2]	HLMP-P505-G0011
HLMP-P505#012 ^[2]	HLMP-P505-G0012
HLMP-P505#021 ^[2]	HLMP-P505-G0021
HLMP-P505#022 ^[2]	HLMP-P505-G0022
HLMP-P505#031 ^[2]	HLMP-P505-G0031
HLMP-P505#032 ^[2]	HLMP-P505-G0032
HLMP-P505#1L1 ^[2]	HLMP-P505-G001L
HLMP-P505#1S1 ^[2]	HLMP-P505-G001S
HLMP-P505#2S1 ^[2]	HLMP-P505-G002S
HLMP-P505#S02	HLMP-P505-KL000
HLMP-P605	HLMP-P605
HLMP-P605#011	HLMP-P605-F0011
HLMP-P605#012	HLMP-P605-F0012
HLMP-P605#022	HLMP-P605-F0022
HLMP-P605#031	HLMP-P605-F0031
HLMP-P605#1L1	HLMP-P605-F001L
HLMP-P605#1S1	HLMP-P605-F001S
HLMP-Q100	HLMP-Q100
HLMP-Q100#012	HLMP-Q100-M0012
HLMP-Q101	HLMP-Q100-N0000
HLMP-Q101#010	HLMP-Q100-N0010
HLMP-Q101#011	HLMP-Q100-N0011
HLMP-Q101#012	HLMP-Q100-N0012

NOTES

^[1] New Part Added

^[2] Revised

^[3] Omitted From List; Old Part Number To Be Retained

^[4] List Sorted By Old Part Numbers

^[5] This Is The Final Revision For This Part Number Change

HP LED PART-NUMBER CHANGE CROSS-REFERENCE LIST

Revision 2.0^[5] (11 May 1999)

Old Part Number^[4]	New Part Number
HLMP-Q101#021	HLMP-Q100-N0021
HLMP-Q101#022	HLMP-Q100-N0022
HLMP-Q101#024	HLMP-Q100-N0024
HLMP-Q101#031	HLMP-Q100-N0031
HLMP-Q101#032	HLMP-Q100-N0032
HLMP-Q101#1L1	HLMP-Q100-N001L
HLMP-Q101#1S1	HLMP-Q100-N001S
HLMP-Q101#2L1	HLMP-Q100-N002L
HLMP-Q101#2S1	HLMP-Q100-N002S
HLMP-Q101#S02	HLMP-Q100-PQ000
HLMP-Q102	HLMP-Q102
HLMP-Q102#011	HLMP-Q102-N0011
HLMP-Q105	HLMP-Q105
HLMP-Q105#010 ^[2]	HLMP-Q105-P0010
HLMP-Q105#011 ^[2]	HLMP-Q105-P0011
HLMP-Q105#012 ^[2]	HLMP-Q105-P0012
HLMP-Q105#021 ^[2]	HLMP-Q105-P0021
HLMP-Q105#022 ^[2]	HLMP-Q105-P0022
HLMP-Q105#031 ^[2]	HLMP-Q105-P0031
HLMP-Q105#032 ^[2]	HLMP-Q105-P0032
HLMP-Q105#1L1 ^[2]	HLMP-Q105-P001L
HLMP-Q105#1S1 ^[2]	HLMP-Q105-P001S
HLMP-Q105#S02	HLMP-Q105-ST000
HLMP-Q106	HLMP-Q106
HLMP-Q106#011 ^[2]	HLMP-Q106-R0011
HLMP-Q106#021 ^[2]	HLMP-Q106-R0021
HLMP-Q106#031 ^[2]	HLMP-Q106-R0031
HLMP-Q106#1S1 ^[2]	HLMP-Q106-R001S
HLMP-Q150	HLMP-Q150
HLMP-Q150#010	HLMP-Q150-F0010
HLMP-Q150#011	HLMP-Q150-F0011
HLMP-Q150#012	HLMP-Q150-F0012
HLMP-Q150#021	HLMP-Q150-F0021
HLMP-Q150#022	HLMP-Q150-F0022
HLMP-Q150#031	HLMP-Q150-F0031
HLMP-Q150#032	HLMP-Q150-F0032
HLMP-Q150#1L1	HLMP-Q150-F001L
HLMP-Q150#1S1	HLMP-Q150-F001S
HLMP-Q150#2S1	HLMP-Q150-F002S
HLMP-Q152	HLMP-Q152
HLMP-Q152#011	HLMP-Q152-G0011
HLMP-Q152#031	HLMP-Q152-G0031
HLMP-Q155	HLMP-Q155
HLMP-Q155#010	HLMP-Q155-F0010
HLMP-Q155#011	HLMP-Q155-F0011
HLMP-Q155#012	HLMP-Q155-F0012

NOTES

^[1] New Part Added

^[2] Revised

^[3] Omitted From List; Old Part Number To Be Retained

^[4] List Sorted By Old Part Numbers

^[5] This Is The Final Revision For This Part Number Change

HP LED PART-NUMBER CHANGE CROSS-REFERENCE LIST

Revision 2.0^[5] (11 May 1999)

Old Part Number^[4]	New Part Number
HLMP-Q155#021	HLMP-Q155-F0021
HLMP-Q155#022	HLMP-Q155-F0022
HLMP-Q155#024	HLMP-Q155-F0024
HLMP-Q155#031	HLMP-Q155-F0031
HLMP-Q155#032	HLMP-Q155-F0032
HLMP-Q155#1L1	HLMP-Q155-F001L
HLMP-Q155#1S1	HLMP-Q155-F001S
HLMP-Q155#2S1	HLMP-Q155-F002S
HLMP-Q156	HLMP-Q156
HLMP-Q156#011 ^[2]	HLMP-Q156-H0011
HLMP-Q156#021 ^[2]	HLMP-Q156-H0021
HLMP-Q156#031 ^[2]	HLMP-Q156-H0031
HLMP-Q400	HLMP-Q400
HLMP-Q400#010	HLMP-Q400-F0010
HLMP-Q400#011	HLMP-Q400-F0011
HLMP-Q400#012	HLMP-Q400-F0012
HLMP-Q400#021	HLMP-Q400-F0021
HLMP-Q400#022	HLMP-Q400-F0022
HLMP-Q400#031	HLMP-Q400-F0031
HLMP-Q400#032	HLMP-Q400-F0032
HLMP-Q405	HLMP-Q405
HLMP-Q405#011	HLMP-Q405-H0011
HLMP-Q405#012	HLMP-Q405-H0012
HLMP-Q600	HLMP-Q600
HLMP-Q600#010	HLMP-Q600-F0010
HLMP-Q600#011	HLMP-Q600-F0011
HLMP-Q605	HLMP-Q605
HLMP-Q605#011	HLMP-Q605-F0011
HLMP-Q605#012	HLMP-Q605-F0012
HLMP-Q605#031	HLMP-Q605-F0031
HLMP-R100	HLMP-R100
HLMP-R100#S02	HLMP-R100-FG000
HLMP-S100	HLMP-S100
HLMP-S200	HLMP-S201-D0000
HLMP-S200#S02	HLMP-S201-EF000
HLMP-S201	HLMP-S201
HLMP-S201#002	HLMP-S201-E0002
HLMP-S300	HLMP-S301-B0000
HLMP-S300#2DG	HLMP-S301-B00DG
HLMP-S301	HLMP-S301
HLMP-S301#002	HLMP-S301-C0002
HLMP-S301#S22	HLMP-S301-CDB00
HLMP-S500	HLMP-S501-C0000
HLMP-S500#S02	HLMP-S501-DE000
HLMP-S501	HLMP-S501
HLMP-S501#002	HLMP-S501-D0002
HLMP-S600	HLMP-S600

NOTES

^[1] New Part Added

^[2] Revised

^[3] Omitted From List; Old Part Number To Be Retained

^[4] List Sorted By Old Part Numbers

^[5] This Is The Final Revision For This Part Number Change

HP LED PART-NUMBER CHANGE CROSS-REFERENCE LIST

Revision 2.0^[5] (11 May 1999)

Old Part Number^[4]	New Part Number
HLMP-S600#2DG	HLMP-S600-A00DG
HLMP-UG06	HLMP-EG08-SV000
HLMP-UG06	HLMP-EG08-SV000
HLMP-UG07	HLMP-EG10-SV000
HLMP-UG07	HLMP-EG10-SV000
HLMP-UG13	HLMP-EG15-PS000
HLMP-UG13	HLMP-EG15-PS000
HLMP-UG14	HLMP-EG17-PS000
HLMP-UG14	HLMP-EG17-PS000
HLMP-UG22	HLMP-EG24-LP000
HLMP-UG22	HLMP-EG24-LP000
HLMP-UG23	HLMP-EG26-LP000
HLMP-UG23	HLMP-EG26-LP000
HLMP-UG28	HLMP-EG30-KN000
HLMP-UG28	HLMP-EG30-KN000
HLMP-UG29	HLMP-EG32-KN000
HLMP-UG29	HLMP-EG32-KN000
HLMP-UH06	HLMP-EH08-SV000
HLMP-UH06	HLMP-EH08-SV000
HLMP-UH07	HLMP-EH10-SV000
HLMP-UH07	HLMP-EH10-SV000
HLMP-UH13	HLMP-EH15-PS000
HLMP-UH13	HLMP-EH15-PS000
HLMP-UH14	HLMP-EH17-PS000
HLMP-UH14	HLMP-EH17-PS000
HLMP-UH22	HLMP-EH24-LP000
HLMP-UH22	HLMP-EH24-LP000
HLMP-UH23	HLMP-EH26-LP000
HLMP-UH23	HLMP-EH26-LP000
HLMP-UH28	HLMP-EH30-KN000
HLMP-UH28	HLMP-EH30-KN000
HLMP-UH29	HLMP-EH32-KN000
HLMP-UH29	HLMP-EH32-KN000
HLMP-UJ06	HLMP-EJ08-TW000
HLMP-UJ06	HLMP-EJ08-TW000
HLMP-UJ07	HLMP-EJ10-TW000
HLMP-UJ07	HLMP-EJ10-TW000
HLMP-UJ13	HLMP-EJ15-PS000
HLMP-UJ13	HLMP-EJ15-PS000
HLMP-UJ14	HLMP-EJ17-PS000
HLMP-UJ14	HLMP-EJ17-PS000
HLMP-UJ22	HLMP-EJ24-MQ000
HLMP-UJ22	HLMP-EJ24-MQ000
HLMP-UJ23	HLMP-EJ26-MQ000
HLMP-UJ23	HLMP-EJ26-MQ000
HLMP-UJ28	HLMP-EJ30-MQ000
HLMP-UJ28	HLMP-EJ30-MQ000
HLMP-UJ29	HLMP-EJ32-MQ000

NOTES

^[1] New Part Added

^[2] Revised

^[3] Omitted From List; Old Part Number To Be Retained

^[4] List Sorted By Old Part Numbers

^[5] This Is The Final Revision For This Part Number Change

HP LED PART-NUMBER CHANGE CROSS-REFERENCE LIST

Revision 2.0^[5] (11 May 1999)

Old Part Number^[4]	New Part Number
HLMP-UJ29	HLMP-EJ32-MQ000
HLMP-UL06	HLMP-EL08-SV000
HLMP-UL06	HLMP-EL08-SV000
HLMP-UL07	HLMP-EL10-SV000
HLMP-UL07	HLMP-EL10-SV000
HLMP-UL13	HLMP-EL15-PS000
HLMP-UL13	HLMP-EL15-PS000
HLMP-UL14	HLMP-EL17-PS000
HLMP-UL14	HLMP-EL17-PS000
HLMP-UL22	HLMP-EL24-MQ000
HLMP-UL22	HLMP-EL24-MQ000
HLMP-UL23	HLMP-EL26-MQ000
HLMP-UL23	HLMP-EL26-MQ000
HLMP-UL28	HLMP-EL30-LP000
HLMP-UL28	HLMP-EL30-LP000
HLMP-UL29	HLMP-EL32-LP000
HLMP-UL29	HLMP-EL32-LP000
HLMT-PH00	HLMT-PH00
HLMT-PH00#011	HLMT-PH00-P0011
HLMT-PH00#012	HLMT-PH00-P0012
HLMT-PH00#021	HLMT-PH00-P0021
HLMT-PH00#022	HLMT-PH00-P0022
HLMT-PL00	HLMT-PL00
HLMT-PL00#011	HLMT-PL00-P0W 11
HLMT-PL00#012	HLMT-PL00-P0W 12
HLMT-PL00#022	HLMT-PL00-P0W 22
HLMT-PL00#031	HLMT-PL00-P0W 31
HLMT-QH00	HLMT-QH00
HLMT-QH00#011	HLMT-QH00-T0011
HLMT-QH00#021	HLMT-QH00-T0021
HLMT-QL00	HLMT-QL00
HLMT-QL00#011	HLMT-QL00-T0011
HLMT-QL00#021	HLMT-QL00-T0021
HPDL-1414	HPDL-1414
QCMS-2917	HCMS-2913-FGA00
QDSC-A002	HDSP-F103-EF000
QDSJ-G001	HDSP-G201-EF000
QDSJ-K003	HDSP-5721-FG000
QDSP-2259	HDSP-2133-JK000
QDSP-3195	5082-7611-DE000
QDSP-3770	5082-7653-CE000
QDSP-3826	5082-7651-DD000
QDSP-3892	5082-7651-DD000
QDSP-3893	5082-7651-B0020
QDSP-4199	5082-7663-EE000
QDSP-4244	HDSP-4200-DEZ00
QDSP-4696	HDSP-4601-JJ400
QDSP-4978	HDSP-4830-GG000

NOTES

- ^[1] New Part Added
- ^[2] Revised
- ^[3] Omitted From List; Old Part Number To Be Retained
- ^[4] List Sorted By Old Part Numbers
- ^[5] This Is The Final Revision For This Part Number Change

HP LED PART-NUMBER CHANGE CROSS-REFERENCE LIST

Revision 2.0^[5] (11 May 1999)

Old Part Number^[4]	New Part Number
QDSP-5499	HDSP-5401-JL300
QDSP-549H	HDSP-515H-GH000
QDSP-5522	HDSP-5521-GH000
QDSP-5550	HDSP-5501-GH000
QDSP-5552	HDSP-5507-GH000
QDSP-5560	HDSP-5521-F0000
QDSP-5566	HDSP-5521-F0025
QDSP-5606	HDSP-5601-GH000
QDSP-5714	HDSP-5701-FGB00
QDSP-5717	HDSP-5701-FGB00
QDSP-5720	HDSP-5703-FGB00
QDSP-5724	HDSP-5723-FG000
QDSP-6680	HPDL-1414
QDSP-6692	HPDL-1414-HI000
QDSP-7443	HDSP-7403-DEB00
QDSP-7449	HDSP-7401-DE300
QDSP-7486	HDSP-7401-C0Z00
QDSP-7599	HDSP-7503-DD000
QDSP-7877	HDSP-7803-JKC00
QDSP-A133	HDSP-A101-GG000
QDSP-A134	HDSP-A103-GG000
QDSP-A145	HDSP-A101-FG000
QDSP-A492	HDSP-A403-BJ000
QDSP-A494	HDSP-A403-BJ000
QDSP-A991	HDSP-A903-GHC00
QDSP-A999	HDSP-A901-HH000
QDSP-E141	HDSP-E101-EF000
QDSP-F199	HDSP-F153-NN000
QDSP-F245	HDSP-F213-DE000
QDSP-F348	HDSP-F303-DE016
QDSP-F493	HDSP-F403-DD000
QDSP-F598	HDSP-F503-JK016
QDSP-F599	HDSP-F503-JK000
QDSP-H124	HDSP-H103-DD000
QDSP-H129	HDSP-H103-EE000
QDSP-H147	HDSP-H101-CD000
QDSP-H197	HDSP-H153-LL000
QDSP-H581	HDSP-5603-HH000
QDSP-H597	HDSP-5601-HH400
QDSP-H796	HDSP-5553-BC000
QDSP-H799	HDSP-5551-AB000
QDSP-K199	HDSP-K121-DD000
QDSP-K231	HDSP-5521-GH000
QDSP-K594	HDSP-5621-HH400
QDSP-K595	HDSP-5621-HH000
QDSP-L249	HDSP-L201-G0000
QDSP-N145	HDSP-N101-C0033
QDSP-U248	HDSP-U213-CD036

NOTES

^[1] New Part Added

^[2] Revised

^[3] Omitted From List; Old Part Number To Be Retained

^[4] List Sorted By Old Part Numbers

^[5] This Is The Final Revision For This Part Number Change

HP LED PART-NUMBER CHANGE CROSS-REFERENCE LISTRevision 2.0^[5] (11 May 1999)

Old Part Number^[4]	New Part Number
QDSP-U249	HDSP-U211-CD036
QDSP-U494	HDSP-U413-LN000
QLMA-PL44#011	HLMA-PL00-QRX11
QLMA-PL49#011	HLMA-PL00-PRR11
QLMA-QG49 ^[2]	HLMA-QG00-TV000
QLMA-QH47#011	HLMA-QH00-T0011
QLMA-QH49#011	HLMA-QH00-UW011
QLMA-QL40#011	HLMA-QL00-UV011
QLMA-QL42#011	HLMA-QL00-TVB11
QLMA-QL43#011	HLMA-QL00-TU011
QLMA-QL45#011	HLMA-QL00-TVK11
QLMA-QL46#011	HLMA-QL00-UWB11
QLMJ-P008#011	HLMA-PL00-PRX11
QLMP-2313	HLMP-2300-C0000
QLMP-2513	HLMP-2500-C0000
QLMP-2583	HLMP-2566-F0001

NOTES

Sorted By Old Part Number

^[1] New Part Added^[2] Revised^[3] Omitted From List - Old Part Number To Be Retained^[4] List Sorted By Old Part Numbers^[5] This Is The Final Revision For This Part Number Change

**The Following Part Numbers Have Been Omitted From The List Above.
The Old Part Numbers Will Be Retained For These Devices.**

Old Part Number	New Part Number
HCMS-2910 ^[3]	Not Applicable - Old Part Number Will Be Retained
HDSP-0723 ^[3]	Not Applicable - Old Part Number Will Be Retained
HDSP-0795 ^[3]	Not Applicable - Old Part Number Will Be Retained
HDSP-0882 ^[3]	Not Applicable - Old Part Number Will Be Retained
HDSP-0982 ^[3]	Not Applicable - Old Part Number Will Be Retained
HDSP-2069 ^[3]	Not Applicable - Old Part Number Will Be Retained
HDSP-2070 ^[3]	Not Applicable - Old Part Number Will Be Retained
HDSP-2108 ^[3]	Not Applicable - Old Part Number Will Be Retained
HDSP-2113#C89 ^[3]	Not Applicable - Old Part Number Will Be Retained
HDSP-2128 ^[3]	Not Applicable - Old Part Number Will Be Retained
HDSP-2128#F00 ^[3]	Not Applicable - Old Part Number Will Be Retained

NOTES^[1] New Part Added^[2] Revised^[3] Omitted From List; Old Part Number To Be Retained^[4] List Sorted By Old Part Numbers^[5] This Is The Final Revision For This Part Number Change

HP LED PART-NUMBER CHANGE CROSS-REFERENCE LIST

Revision 2.0^[5] (11 May 1999)

Old Part Number^[4]	New Part Number
HDSP-2206 ^[3]	Not Applicable - Old Part Number Will Be Retained
HDSP-2323 ^[3]	Not Applicable - Old Part Number Will Be Retained
HDSP-2343 ^[3]	Not Applicable - Old Part Number Will Be Retained
HDSP-2352 ^[3]	Not Applicable - Old Part Number Will Be Retained
HDSP-2353 ^[3]	Not Applicable - Old Part Number Will Be Retained
HDSP-4919 ^[3]	Not Applicable - Old Part Number Will Be Retained
HDSP-K703 ^[3]	Not Applicable - Old Part Number Will Be Retained
HLMA-PL00#032 ^[3]	Not Applicable - Old Part Number Will Be Retained
HLMA-QL00#032 ^[3]	Not Applicable - Old Part Number Will Be Retained
HLMA-QL50 ^[3]	Not Applicable - Old Part Number Will Be Retained
HLMA-QL52 ^[3]	Not Applicable - Old Part Number Will Be Retained
HLMP-0301#ID1 ^[3]	Not Applicable - Old Part Number Will Be Retained
HLMP-0401#001 ^[3]	Not Applicable - Old Part Number Will Be Retained
HLMP-0503#ID2 ^[3]	Not Applicable - Old Part Number Will Be Retained
HLMP-1301#STS ^[3]	Not Applicable - Old Part Number Will Be Retained
HLMP-1302#STS ^[3]	Not Applicable - Old Part Number Will Be Retained
HLMP-1320 ^[3]	Not Applicable - Old Part Number Will Be Retained
HLMP-1385#CBT ^[3]	Not Applicable - Old Part Number Will Be Retained
HLMP-1402#STS ^[3]	Not Applicable - Old Part Number Will Be Retained
HLMP-1440#ID3 ^[3]	Not Applicable - Old Part Number Will Be Retained
HLMP-1485#CBT ^[3]	Not Applicable - Old Part Number Will Be Retained
HLMP-1523#ID2 ^[3]	Not Applicable - Old Part Number Will Be Retained
HLMP-1585#CBT ^[3]	Not Applicable - Old Part Number Will Be Retained
HLMP-1719#2BH ^[3]	Not Applicable - Old Part Number Will Be Retained
HLMP-2305 ^[3]	Not Applicable - Old Part Number Will Be Retained
HLMP-3301#CBT ^[3]	Not Applicable - Old Part Number Will Be Retained
HLMP-3301#STS ^[3]	Not Applicable - Old Part Number Will Be Retained
HLMP-3316#ID2 ^[3]	Not Applicable - Old Part Number Will Be Retained
HLMP-3322 ^[3]	Not Applicable - Old Part Number Will Be Retained
HLMP-3401#CBT ^[3]	Not Applicable - Old Part Number Will Be Retained
HLMP-3507#CBT ^[3]	Not Applicable - Old Part Number Will Be Retained
HLMP-3507#ID2 ^[3]	Not Applicable - Old Part Number Will Be Retained
HLMP-3651#S20 ^[3]	Not Applicable - Old Part Number Will Be Retained
HLMP-3762 ^[3]	Not Applicable - Old Part Number Will Be Retained
HLMP-3814 ^[3]	Not Applicable - Old Part Number Will Be Retained
HLMP-3962 ^[3]	Not Applicable - Old Part Number Will Be Retained
HLMP-4700#100 ^[3]	Not Applicable - Old Part Number Will Be Retained
HLMP-4740#2DD ^[3]	Not Applicable - Old Part Number Will Be Retained
HLMP-4740#ID2 ^[3]	Not Applicable - Old Part Number Will Be Retained
HLMP-5030 ^[3]	Not Applicable - Old Part Number Will Be Retained
HLMP-5030#STS ^[3]	Not Applicable - Old Part Number Will Be Retained
HLMP-5040 ^[3]	Not Applicable - Old Part Number Will Be Retained
HLMP-5040#S02 ^[3]	Not Applicable - Old Part Number Will Be Retained

NOTES

^[1] New Part Added

^[2] Revised

^[3] Omitted From List; Old Part Number To Be Retained

^[4] List Sorted By Old Part Numbers

^[5] This Is The Final Revision For This Part Number Change

HP LED PART-NUMBER CHANGE CROSS-REFERENCE LIST

Revision 2.0^[5] (11 May 1999)

Old Part Number^[4]	New Part Number
HLMP-5060 ^[3]	Not Applicable - Old Part Number Will Be Retained
HLMP-5060#S02 ^[3]	Not Applicable - Old Part Number Will Be Retained
HLMP-5080 ^[3]	Not Applicable - Old Part Number Will Be Retained
HLMP-5080#S02 ^[3]	Not Applicable - Old Part Number Will Be Retained
HLMP-6305#S02 ^[3]	Not Applicable - Old Part Number Will Be Retained
HLMP-6505#014 ^[3]	Not Applicable - Old Part Number Will Be Retained
HLMP-6505#024 ^[3]	Not Applicable - Old Part Number Will Be Retained
HLMP-6505#034 ^[3]	Not Applicable - Old Part Number Will Be Retained
HLMP-6830 ^[3]	Not Applicable - Old Part Number Will Be Retained
HLMP-D150#ID1 ^[3]	Not Applicable - Old Part Number Will Be Retained
HLMP-D202 ^[3]	Not Applicable - Old Part Number Will Be Retained
HLMP-D203 ^[3]	Not Applicable - Old Part Number Will Be Retained
HLMP-D203#002 ^[3]	Not Applicable - Old Part Number Will Be Retained
HLMP-D400#001 ^[3]	Not Applicable - Old Part Number Will Be Retained
HLMP-K155#ID2 ^[3]	Not Applicable - Old Part Number Will Be Retained
HLMP-K402#ID2 ^[3]	Not Applicable - Old Part Number Will Be Retained
HLMP-KG50 ^[3]	Not Applicable - Old Part Number Will Be Retained
HLMP-KN50 ^[3]	Not Applicable - Old Part Number Will Be Retained
HLMP-P105#024 ^[3]	Not Applicable - Old Part Number Will Be Retained
HLMP-P105#034 ^[3]	Not Applicable - Old Part Number Will Be Retained
HLMP-Q104 ^[3]	Not Applicable - Old Part Number Will Be Retained
HLMP-Q105#024 ^[3]	Not Applicable - Old Part Number Will Be Retained
HLMP-Q105#034 ^[3]	Not Applicable - Old Part Number Will Be Retained
HLMP-S200#2DG ^[3]	Not Applicable - Old Part Number Will Be Retained
HLMT-PH00#031 ^[3]	Not Applicable - Old Part Number Will Be Retained
HLMT-PL00#021 ^[3]	Not Applicable - Old Part Number Will Be Retained
HLMT-QH00#031 ^[3]	Not Applicable - Old Part Number Will Be Retained
HLMT-QL00#031 ^[3]	Not Applicable - Old Part Number Will Be Retained
QDSP-0605 ^[3]	Not Applicable - Old Part Number Will Be Retained
QDSP-0785 ^[3]	Not Applicable - Old Part Number Will Be Retained
QDSP-3684 ^[3]	Not Applicable - Old Part Number Will Be Retained
QDSP-K149 ^[3]	Not Applicable - Old Part Number Will Be Retained
QDSP-K597 ^[3]	Not Applicable - Old Part Number Will Be Retained
QLMA-PH49#011 ^[3]	Not Applicable - Old Part Number Will Be Retained
QLMA-PL49 ^[3]	Not Applicable - Old Part Number Will Be Retained
QLMA-QH49 ^[3]	Not Applicable - Old Part Number Will Be Retained
QLMA-QL42 ^[3]	Not Applicable - Old Part Number Will Be Retained
QLMA-QL46 ^[3]	Not Applicable - Old Part Number Will Be Retained
QLMJ-P017 ^[3]	Not Applicable - Old Part Number Will Be Retained
QLMJ-P017#011 ^[3]	Not Applicable - Old Part Number Will Be Retained
QLMP-2589 ^[3]	Not Applicable - Old Part Number Will Be Retained
QLMP-6392 ^[3]	Not Applicable - Old Part Number Will Be Retained
QLMP-6392#011 ^[3]	Not Applicable - Old Part Number Will Be Retained

NOTES

^[1] New Part Added

^[2] Revised

^[3] Omitted From List; Old Part Number To Be Retained

^[4] List Sorted By Old Part Numbers

^[5] This Is The Final Revision For This Part Number Change

HP LED PART-NUMBER CHANGE CROSS-REFERENCE LIST

Revision 2.0^[5] (11 May 1999)

Old Part Number^[4]	New Part Number
QLMP-6392#1S1 ^[3]	Not Applicable - Old Part Number Will Be Retained
QLMP-6484 ^[3]	Not Applicable - Old Part Number Will Be Retained
QLMP-6484#1L1 ^[3]	Not Applicable - Old Part Number Will Be Retained
QLMP-7026 ^[3]	Not Applicable - Old Part Number Will Be Retained
QLMP-7026#031 ^[3]	Not Applicable - Old Part Number Will Be Retained
QLMP-7032 ^[3]	Not Applicable - Old Part Number Will Be Retained
QLMP-7032#031 ^[3]	Not Applicable - Old Part Number Will Be Retained
QLMP-P392 ^[3]	Not Applicable - Old Part Number Will Be Retained
QLMP-P392#1S1 ^[3]	Not Applicable - Old Part Number Will Be Retained
QLMP-P580 ^[3]	Not Applicable - Old Part Number Will Be Retained
QLMP-P649 ^[3]	Not Applicable - Old Part Number Will Be Retained
QLMP-P649#011 ^[3]	Not Applicable - Old Part Number Will Be Retained
QLMP-P649#031 ^[3]	Not Applicable - Old Part Number Will Be Retained

NOTES

Sorted By Old Part Number

[1] New Part Added

[2] Revised

[3] Omitted From List - Old Part Number To Be Retained

[4] List Sorted By Old Part Numbers

[5] This Is The Final Revision For This Part Number Change

NOTES

[1] New Part Added

[2] Revised

[3] Omitted From List; Old Part Number To Be Retained

[4] List Sorted By Old Part Numbers

[5] This Is The Final Revision For This Part Number Change

Standard SMT and Through Hole Lead Bend Options for Subminiature LED Lamps

Technical Data

**Option 011, 012, 013,
021, 022, 031, 032, 1L1,
1S1, 2L1, 2S1**

Features

- **Surface Mount Lead Configurations**
- **Right Angle Lead Bend for Through Hole Mounting**
- **Tape and Reel in Accordance with ANSI/EIA RS-481 Specifications**

Description

Subminiature lamps (HLMP-PXXX, HLMP-Q1XX, HLMP-6XXX, HLMP-70XX) are available with the above standard options. Subminiature Lamps with Options 01X, 02X and 03X are suitable for surface mount applications and their leads are formed with gull wing, yoke bend and Z bend respectively. They are available in Tape and Reel (compatible to ANSI/EIA RS-481), bulk or arrays in a shipping tube. Option 1X1 and 2X1 are right angle lead bends suitable for through hole applications.

Ordering Information

To order Subminiature Lamps packaged with these standard options, include the appropriate option code along with the device catalog part number. Example: to order the HLMP-P005 with Option 011 gull wing leads in 12 mm embossed tape on 178 mm (7 inch) diameter reels, with 1500 lamps per reel; order as follows: HLMP-P005 Option 011. Order quantities must be placed in reel increments only. Orders for partial reels will not be accepted. For additional information, please contact your local Agilent Technologies sales office or franchised distributor for assistance.

Selection Guide

Option Code	Package Configuration		Package Outline Drawing	
011	Gull Wing Leads, 12 mm Tape on 7 in. Dia. Reel, 1500 Parts per Reel ^[1]	Surface Mount Lead Configurations	A, I, M	
012	Gull Wing Lead, Bulk Packaging, Quantity of 500 Parts ^[2]			
013	Gull Wing Leads, Arrays, Shipping Tube, Quantity see Figure J		B, J	
014	Gull Wing Leads, 12 mm Tape on 13 in. Dia. Reel, 6000 Parts per Reel ^[1]		A, I, M	
021	Yoke Leads, 12 mm Tape on 7 in. Dia. Reel 1500 Parts per Reel ^[1]		C, K, M	
022	Yoke Leads, Bulk Packaging, Quantity of 500 Parts ^[2]			
024	Yoke Leads, 12 mm Tape on 13 in. Dia. Reel, 6000 Parts per Reel ^[1]			
031	Z-Bend Leads, 12 mm Tape on 7 in. Dia. Reel 1500 Parts per Reel ^[1]		D, L, M	
032	Z-Bend Leads, Bulk Packaging, Quantity of 500 Parts ^[2]			
034	Z-Bend Leads, 12 mm Tape on 13 in. Dia. Reel, 6000 Parts per Reel ^[1]			
1L1 ^[3]	2.54 mm (0.100 inch)	Long Leads; 10.4 mm (0.410 in.)	Right Angle Lead Bends for Through Hole Mounting	E
1S1 ^[3]	Center Lead Spacing	Short Leads; 3.7 mm (0.145 in.)		F
2L1 ^[3]	5.08 mm (0.200 inch)	Long Leads; 9.2 mm (0.364 in.)		G
2S1 ^[3]	Center Lead Spacing	Short Leads; 3.7 mm (0.145 in.)		H

Notes:

- SMT lamps are supplied in 12 mm embossed carrier tape. Minimum order is for one full reel, either 7 inch or 13 inch. All other order quantities must be in reel increments only. Orders for partial reels are not accepted.
- Vapor barrier bags are used for bulk packaging.
- Not applicable for all AlInGaP devices.

Package Dimensions, Lead Bend Options

(A) Individual Lamp, Gull Wing Lead, Option 011, 012, and 014

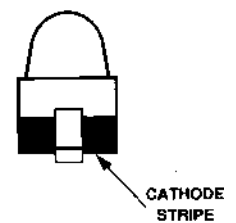
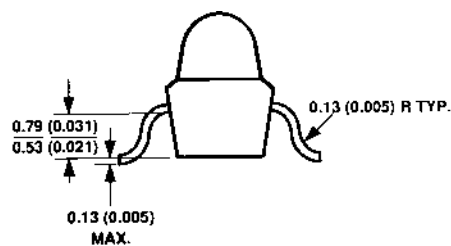
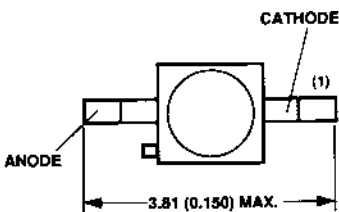

ALL DIMENSIONS ARE IN MILLIMETRES (INCHES)

(B) Subminiature Array, Gull Wing Lead, Option 013

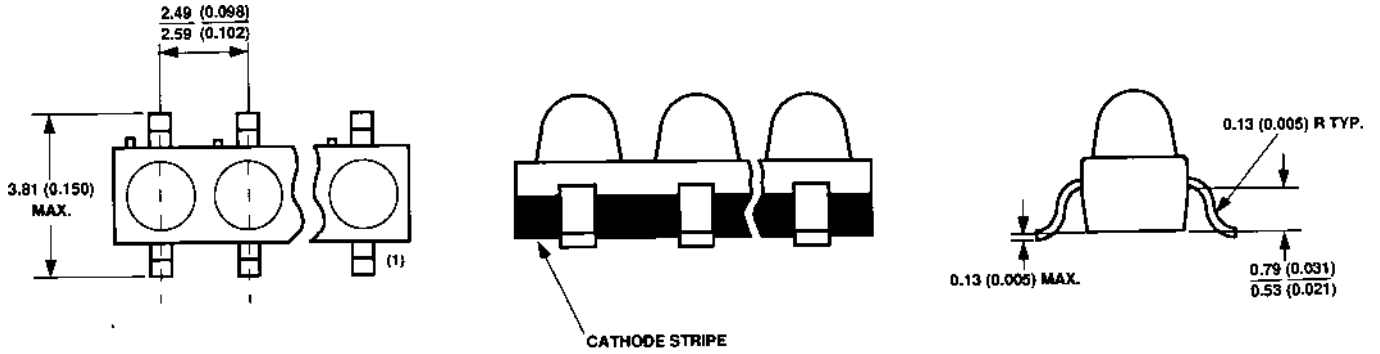

ALL DIMENSIONS ARE IN MILLIMETRES (INCHES)

(1) DUE TO SHEARING PROCESS, LEAD WIDTH AT END MAY VARY 0.483 mm/0.663 mm.

(C) Individual Lamp, "Yoke" Lead, Options 021, 022, and 024

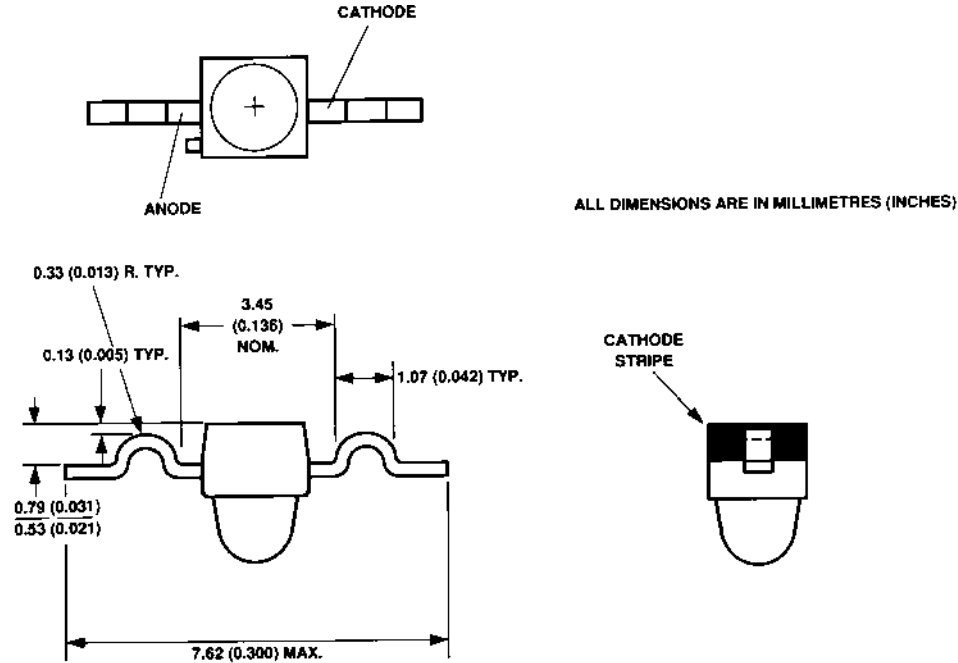

ALL DIMENSIONS ARE IN MILLIMETRES (INCHES)

(D) Individual Lamp, Z-Bend Lead, Option 031, 032, and 034

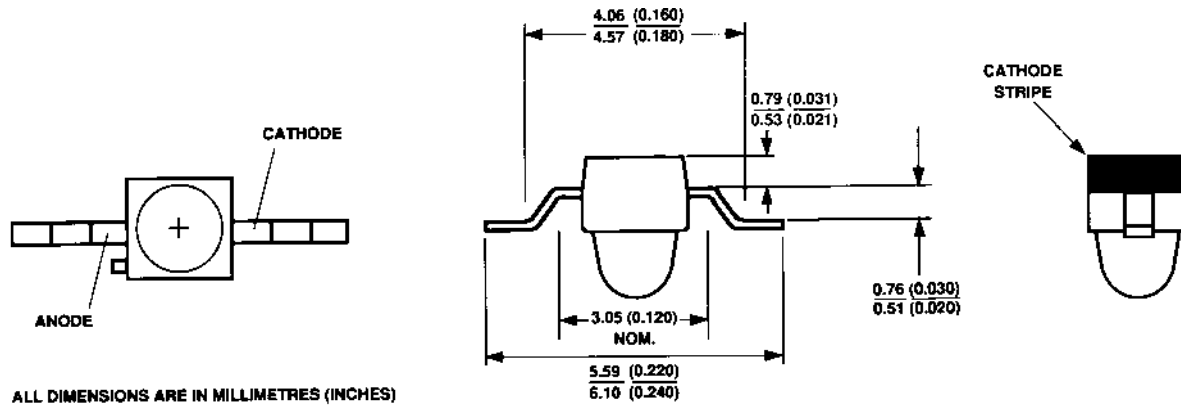

(E) Individual Lamp or Array, Rt. Angle Bend Option 1L1

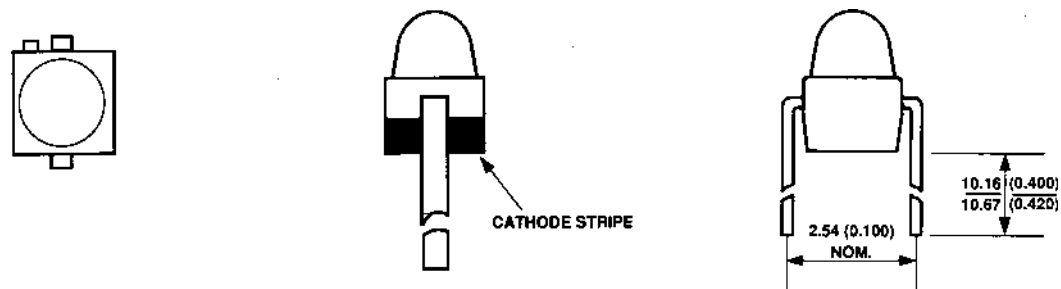

(F) Individual Lamp or Array, Rt. Angle Bend Option 1S1

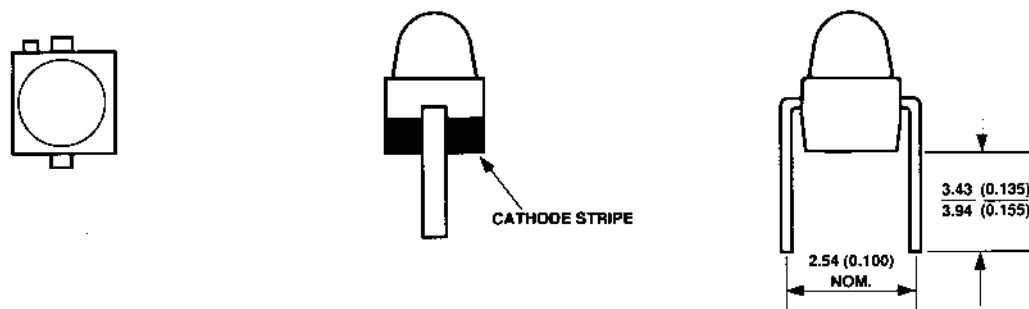

(G) Individual Lamp or Array, Rt. Angle Bend Option 2L1

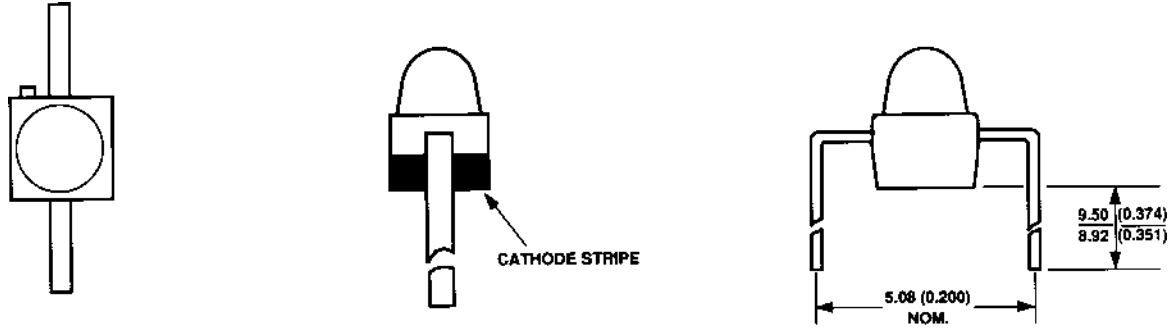

ALL DIMENSIONS ARE IN MILLIMETRES (INCHES)

(H) Individual Lamp or Array, Rt. Angle Bend Option 2S1

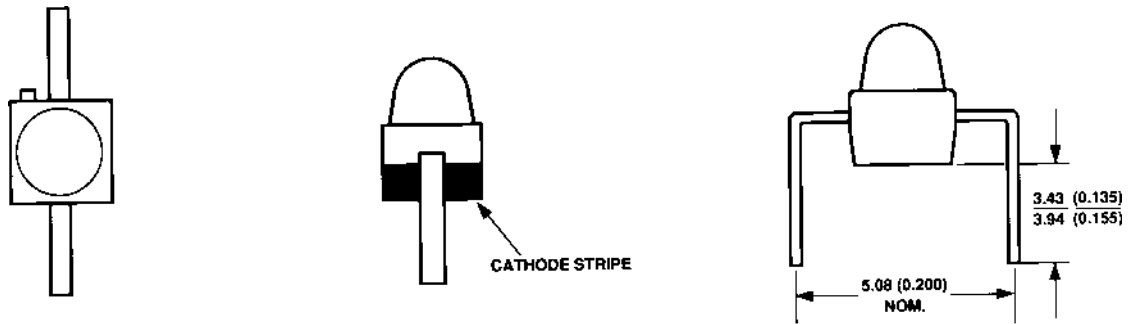

Package Dimensions: Surface Mount Tape and Reel Options

(I) 12 mm Tape and Reel, Gull Wing Lead

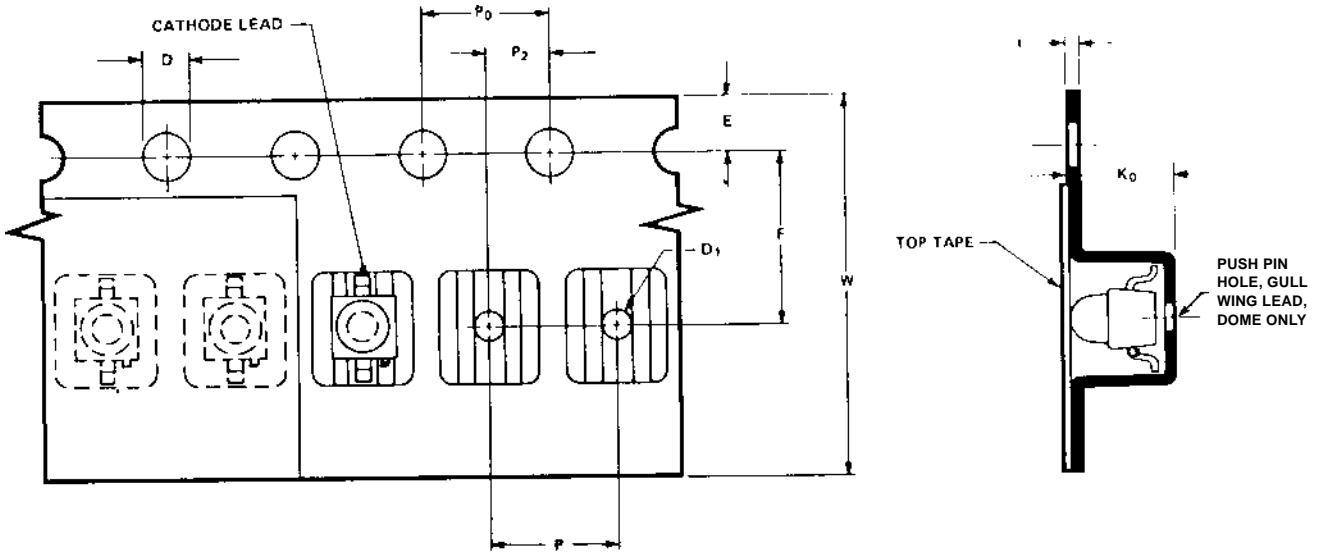

FEED DIRECTION →

GULL WING LEAD
SUBMINIATURE LAMP

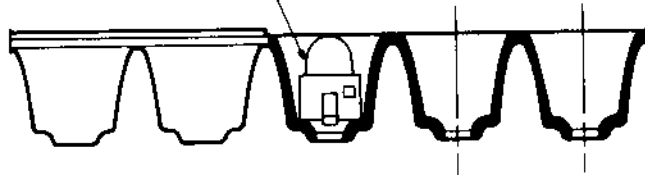

NOTES:

1. EMPTY COMPONENT POCKETS SEALED WITH TOP COVER TAPE.
2. MINIMUM LEADER LENGTH AT EITHER END OF THE TAPE IS 500 mm.
3. THE MAXIMUM NUMBER OF CONSECUTIVE MISSING LAMPS IS TWO.
4. IN ACCORDANCE WITH ANSI/EIA RS-481 SPECIFICATIONS, THE CATHODE IS ORIENTED TOWARDS THE TAPE SPROCKET HOLE.

(J) Array Shipping Tube, Gull Wing Lead

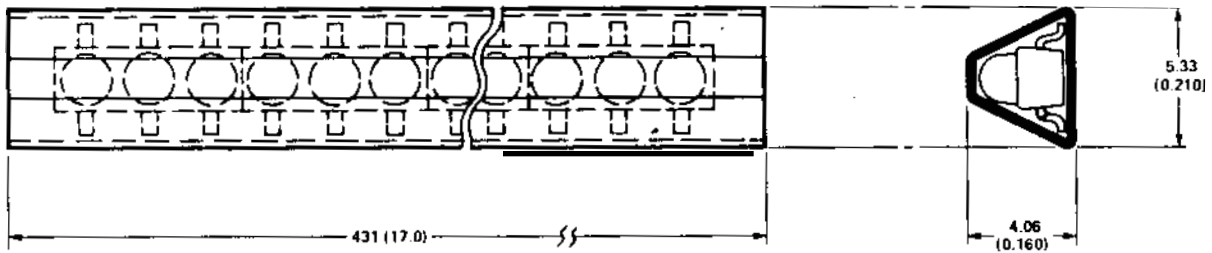

TUBE LABEL IDENTIFIES
CATHODE SIDE OF ARRAYS.

← SUGGESTED TUBE FEED



HLMP-	NO. OF LAMP ELEMENTS PER ARRAY	QUANTITY OF ARRAYS PER TUBE
6XX3	3	53
6XX4	4	40
6XX5	5	32
6XX6	6	26
6XX8	8	20

(K) 12 mm Tape and Reel, "Yoke" Lead

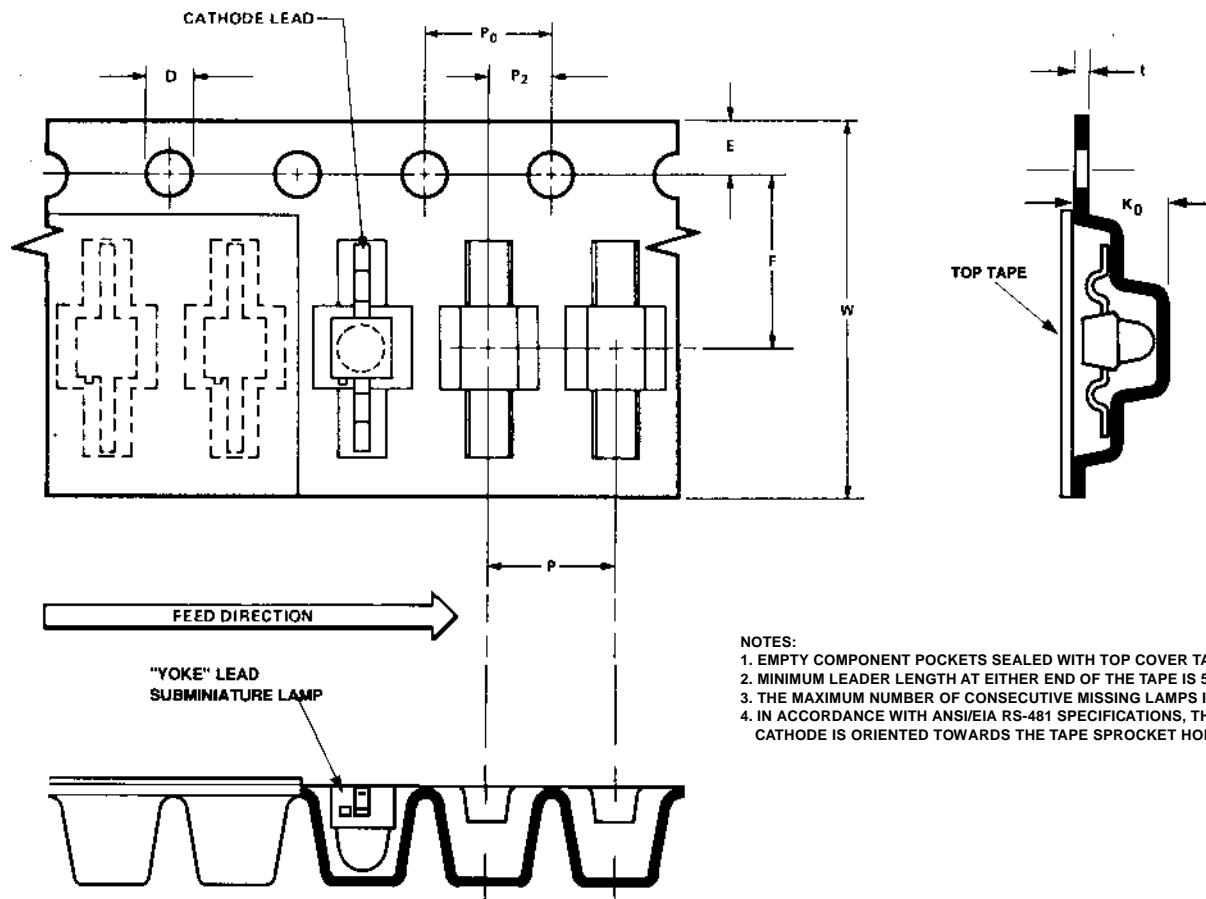

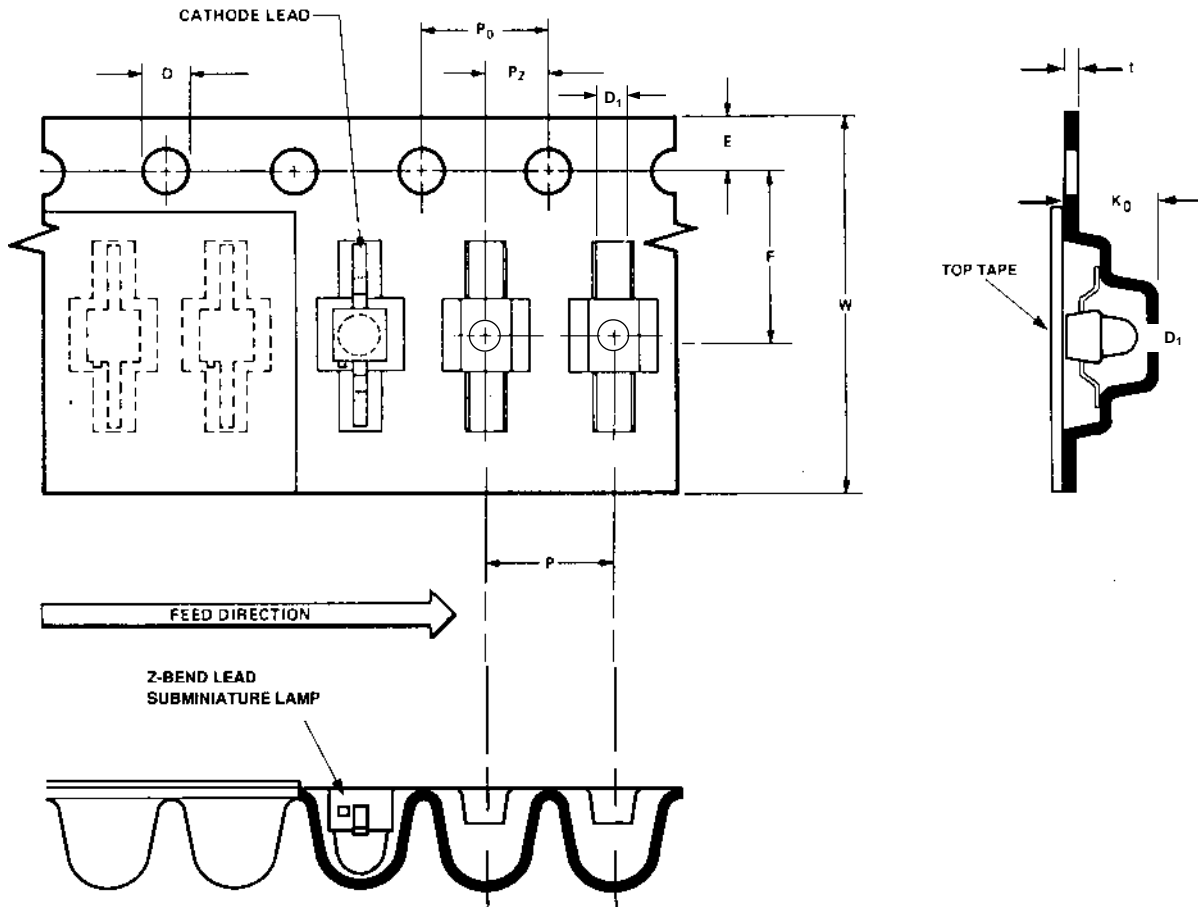
(L) 12 mm Tape and Reel, Z-Bend Lead

	Reel Dimensions Per ANSI/EIA Standard RS-481.	All Dimensions Are in Millimeters (Inches).
	7 inch Reel	13 Inch Reel
A	178.0 ± 2.0 (7.0 ± 0.08) Dia.	330 (12.9) Dia. Max.
C	13.0 (0.512) Dia. Typ.	13.0 (0.512) Dia. Typ.
N	50.0 (1.97) Min.	100.0 (3.93) Min.
T	18.4 (0.72) mMax.	18.4 (0.72) Max.

	Embossed Carrier Tape Dimensions Per ANSI/EIA Standard RS-481.	All Dimensions Are in Millimeters (Inches).			
	Gull Wing Dome	Gull Wing Flat Top	Yoke Dome	Z-Bend Dome	Yoke and Z-Bend Flat Top
D	1.55 (0.061 ± 0.002) Dia.	1.55 (0.061 ± 0.002) Dia.	1.55 (0.061 ± 0.002) Dia.	1.50 + 0.10 (0.059 + 0.004) Dia.	1.50 + 0.10 (0.059 + 0.004) Dia.
D ₁	1.0 (0.039) Dia. Min.	N/A (No Push Pin Hole)	N/A (No Push Pin Hole)	1.50 + 0.25 (0.059 + 0.010)	N/A (No Push Pin Hole)
D ₂	20.2 (0.795) Dia. Min.	20.2 (0.795) Dia. Min.	20.2 (0.795) Dia. Min.	20.2 (0.795) Dia. Min.	20.2 (0.795) Dia. Min.
E	1.75 ± 0.1 (0.069)	1.75 ± 0.1 (0.069)	1.75 ± 0.1 (0.069)	1.75 ± 0.1 (0.069)	1.75 ± 0.1 (0.069)
F	5.50 ± 0.05 (0.217 ± 0.002)				
K ₀	3.05 ± 0.1 (0.120) Typ.	2.54 ± 0.1 (0.100) Typ.	3.05 ± 0.1 (0.120) Typ.	2.97 ± 0.1 (0.117) Typ.	3.05 ± 0.1 (0.120) Typ.
P	4.0 (0.157) Typ.	4.0 (0.157) Typ.	4.0 (0.157) Typ.	4.0 (0.157) Typ.	4.0 (0.157) Typ.
P ₀	4.0 (0.157) Typ.	4.0 (0.157) Typ.	4.0 (0.157) Typ.	4.0 (0.157) Typ.	4.0 (0.157) Typ.
P ₂	2.0 (0.079 ± 0.002)	2.0 (0.079 ± 0.002)	2.0 (0.079 ± 0.002)	2.0 (0.079 ± 0.002)	2.0 (0.079 ± 0.002)
t	0.3 (0.012) Typ.	0.3 (0.012) Typ.	0.3 (0.012) Typ.	0.305 ± 0.013 (0.0120 ± 0.0005)	0.305 ± 0.013 (0.0120 ± 0.0005)
W	12.0 ± 0.3 (0.472 ± 0.012)	12.0 ± 0.3 (0.472 ± 0.012)	12.0 ± 0.3 (0.472 ± 0.012)	12.0 ± 0.3 (0.472 ± 0.012)	12.0 ± 0.3 (0.472 ± 0.012)

(M) 12 mm Tape and Reel

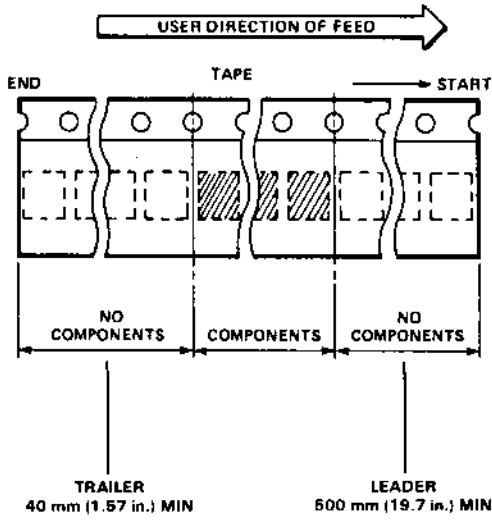

TOLERANCES (UNLESS OTHERWISE SPECIFIED):
 .X ± .1; .XX ± .05 (.XXX ± .004)

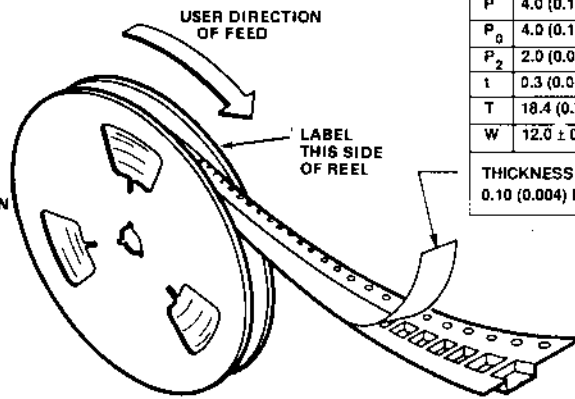

DIMENSIONS PER ANSI/EIA STANDARD RS-481. ALL DIMENSIONS ARE IN MILLIMETRES (INCHES).

A	178.0 ± 2.0 (7.0 ± 0.08) DIA.
C	13.0 (0.512) DIA. TYP.
D	1.55 (0.061 ± 0.002) DIA.
D ₁	1.0 (0.039) DIA. MIN.
D ₂	20.2 (0.795) DIA. MIN.
E	1.75 ± 0.1 (0.069)
F	5.50 (0.127 ± 0.002)
K ₀	3.05 ± 0.1 (0.120) TYP.
N	50.0 (1.970) MIN.
P	4.0 (0.157) TYP.
P ₀	4.0 (0.157) TYP.
P ₂	2.0 (0.079 ± 0.002) TYP.
t	0.3 (0.012) TYP.
T	18.4 (0.72) MAX.
W	12.0 ± 0.3 (0.472 ± 0.012)
THICKNESS OF TOP COVER TAPE 0.10 (0.004) MAX.	

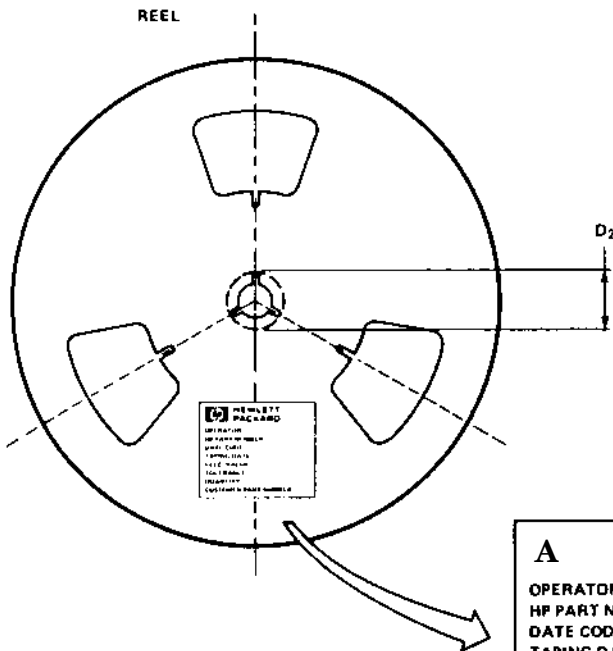

A

OPERATOR _____
 HP PART NUMBER _____
 DATE CODE _____
 TAPING DATE _____
 ELEC. VALUE _____
 TOLERANCE _____
 QUANTITY _____
 CUSTOMER PART NUMBER _____

