

OKI electronic components

OLD122CP3, OLD222CP, OPU850CP, OPU852CP

LED Capsule

GENERAL DESCRIPTION

The OLD122CP3, OLD222CP, OPU850CP, and OPU852CP are sensors that are most suited to paper detection. For superior dustproof packaging and easy mounting, a phototransistor can be sealed (encapsulated) into a package with connectors.

The OPU852CP can be mounted with a space (200mm) between the device and the LED capsule because the device has a non-spherical surface lens.

The OPU850CP and OPU852CP assure a high quality because they have been assembled without soldering or using adhesive.

FEATURES

- The light axis is positioned for efficient insertion into LED capsules and photo capsules.
- The sensor unit element is protected from dust.
- The assembly and mount are easy (without soldering).

APPLICATIONS

- Banking terminals (ATM, etc.)
- Printers
- Copying machines
- Communications terminals (FAX, etc.)

PIN CONFIGURATION

- OLD122CP3, OLD222CP

(Unit: mm)

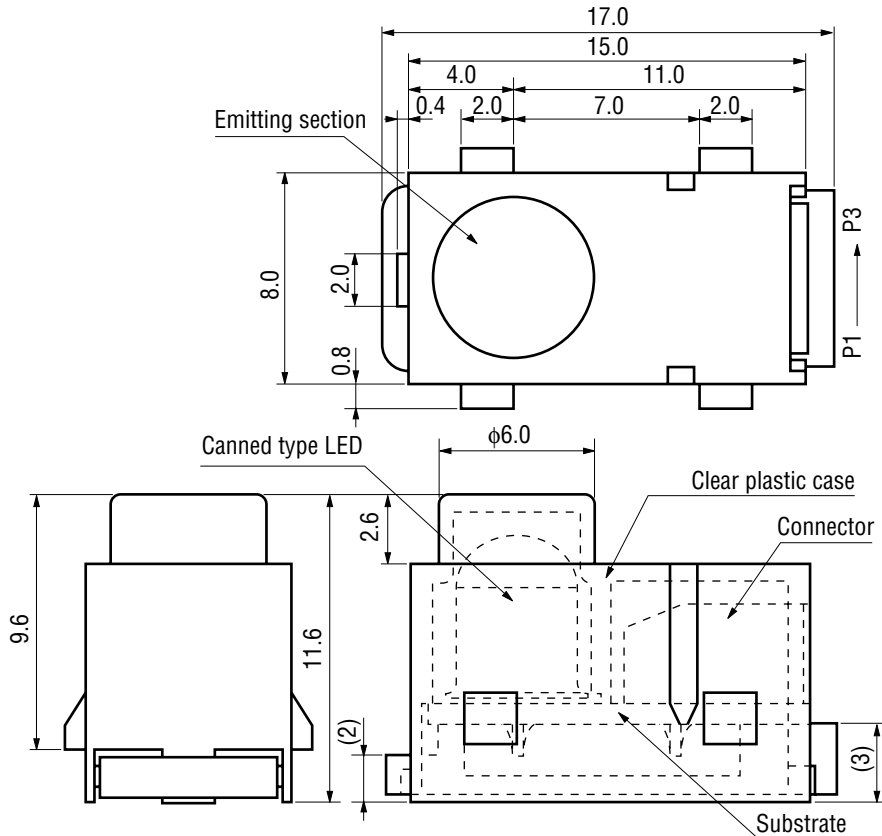

- Pin Connection Diagram
(P No. indicates the pin number of connectors.)

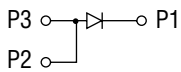

P2, P3: Anode
P1 : Cathode

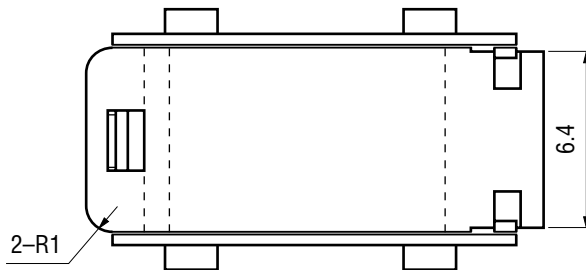

- OPU850CP, OPU852CP

(Unit: mm)

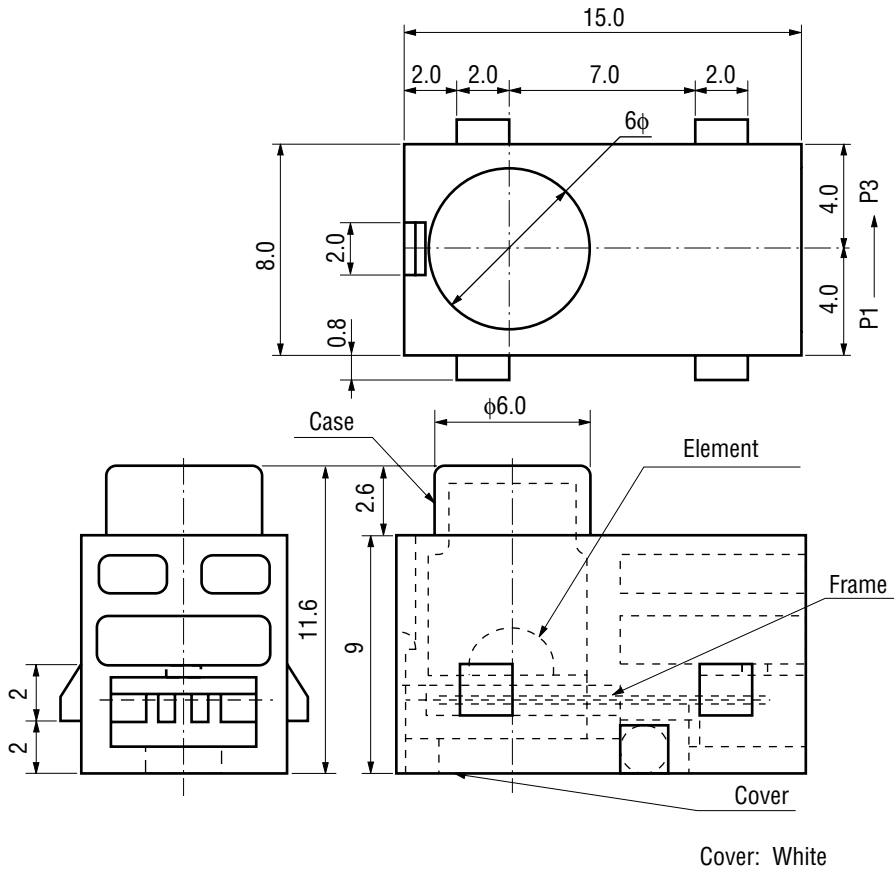

- Pin Connection Diagram
(P No. indicates the pin number of connectors.)

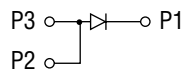

P2, P3: Anode
P1 : Cathode

ABSOLUTE MAXIMUM RATINGS

Parameter	Symbol	Test Condition	Rating		Unit	Note
			OLD122CP3	OLD222CP		
Temperature Storage	T_{stg}	—	-20 to +80		°C	—
Operating Temperature	T_{opr}	—	-10 to +60		°C	—
DC Forward Current	I_F	Ta=25°C	100		mA	—
DC Forward Current Derating Factor	—		1		mA/°C	Ta=25°C or more
Pulse Forward Current	I_{FRM}		1		A	tw=100 μs, T=10 ms
Pulse Forward Current Derating Factor	—		10		mA/°C	Ta=25°C or more
Reverse Voltage	V_R		6		V	—
Power Dissipation	P_D		170	200	mW	—

Parameter	Symbol	Test Condition	Rating		Unit	Note
			OPU850CP	OPU850CP		
Temperature Storage	T_{stg}	—	-10 to +80		°C	—
Operating Temperature	T_{opr}	—	-10 to +60		°C	—
DC Forward Current	I_F	Ta=25°C	60		mA	—
DC Forward Current Derating Factor	—		1.7		mA/°C	Ta=25°C or more
Pulse Forward Current	I_{FRM}		0.5		A	tw=100 μs, T=10 ms
Pulse Forward Current Derating Factor	—		14.3		mA/°C	Ta=25°C or more
Reverse Voltage	V_R		6		V	—
Power Dissipation	P_D		102	120	mW	—

ELECTRICAL AND OPTICAL CHARACTERISTICS

• OLD122CP3, OLD222CP

(Ambient Temperature $T_a=25^\circ\text{C}$)

Parameter	Symbol	Condition	OLD122CP3			OLD222CP			Unit
			Min.	Typ.	Max.	Min.	Typ.	Max.	
Forward Voltage	V_F	$I_F=100\text{ mA}$	1.10	1.3	1.5	1.3	1.55	1.7	V
Reverse Current	I_R	$V_R=6\text{ V}$	—	—	10	—	—	10	μA
Peak-emission Wavelength	λ_P	$I_F=100\text{ mA}$	—	940	—	—	910	—	nm
Output Photocurrent **	I_{P1}	$I_F=50\text{ mA}$ $V_{CE}=1\text{ V}$ $L^*=50\text{ mm}$	1.45	—	5.6	5.5	—	20	mA
	I_{P2}	$I_F=50\text{ mA}$ $V_{CE}=1\text{ V}$ $L^*=200\text{ mm}$	0.12	—	0.44	0.30	—	1.70	mA

• OPU850CP, OPU852CP

(Ambient Temperature $T_a=25^\circ\text{C}$)

Parameter	Symbol	Condition	OPU850CP			OPU852CP			Unit
			Min.	Typ.	Max.	Min.	Typ.	Max.	
Forward Voltage	V_F	$I_F=60\text{ mA}$	—	1.3	1.7	—	1.55	2.0	V
Reverse Current	I_R	$V_R=6\text{ V}$	—	—	10	—	—	10	μA
Peak-emission Wavelength	λ_P	$I_F=60\text{ mA}$	—	940	—	—	910	—	nm
Output Photocurrent **	I_{P1}	$I_F=50\text{ mA}$ $V_{CE}=1\text{ V}$ $L^*=50\text{ mm}$	0.20	—	3.00	5.5	—	28	mA
	I_{P2}	$I_F=50\text{ mA}$ $V_{CE}=1\text{ V}$ $L^*=200\text{ mm}$	10	—	150	400	—	3000	μA

* : Distance between sensors

** : Measuring circuit

Measuring circuit

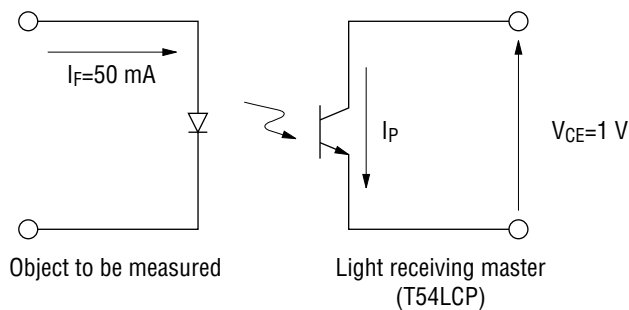

TYPICAL CHARACTERISTICS

- **OLD122CP3—OPU850CP Spectral Distribution**

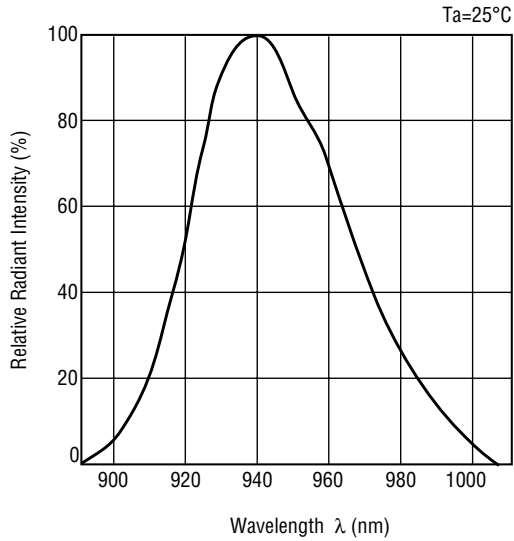

- **OLD222CP—OPU852CP Spectral Distribution**

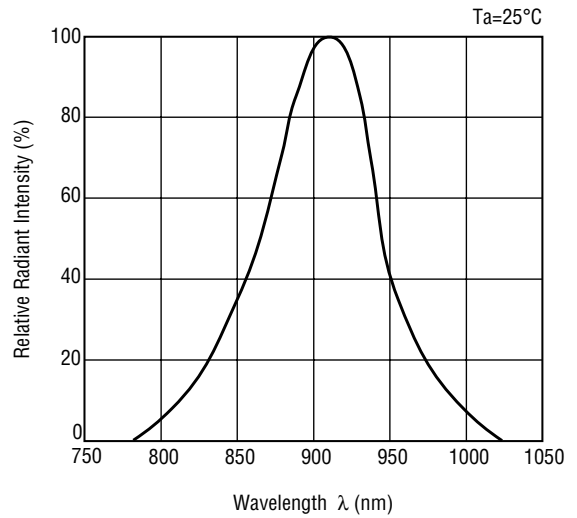

- **OPU850CP Directional Characteristic**

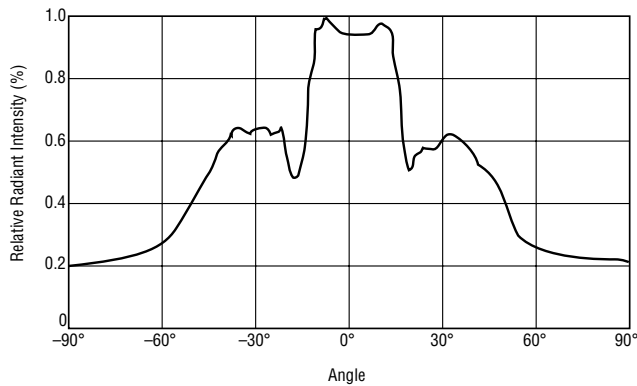

- **OPU852CP Directional Characteristic**

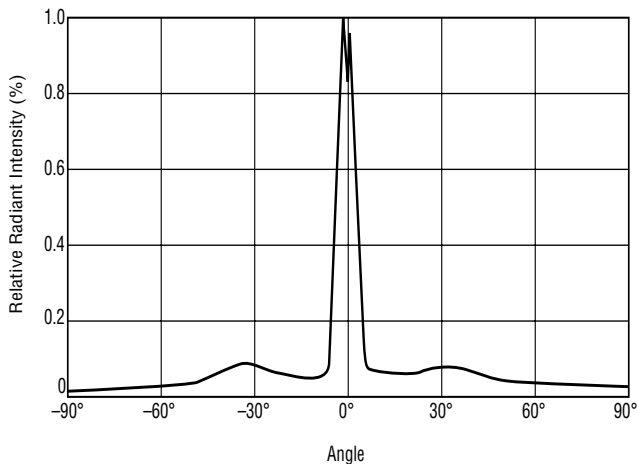

TYPICAL CHARACTERISTIC

- OLD122CP3—T36CP2 Switching Time vs. Load Resistance

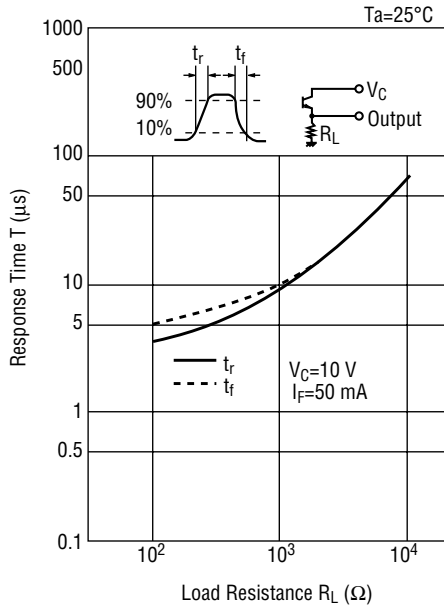

- OLD222CP—T36CP2 Switching Time vs. Load Resistance

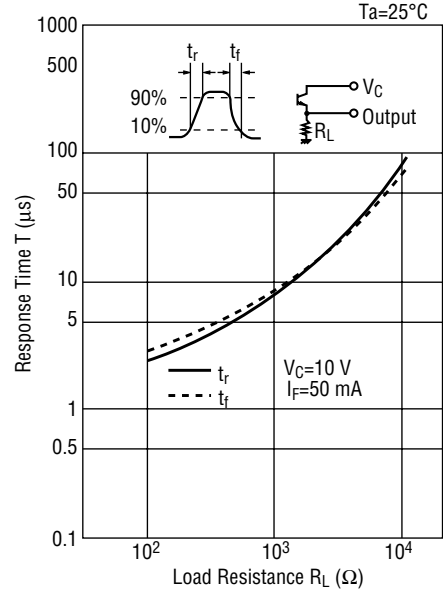

- OLD122CP3—T54LCP Switching Time vs. Load Resistance

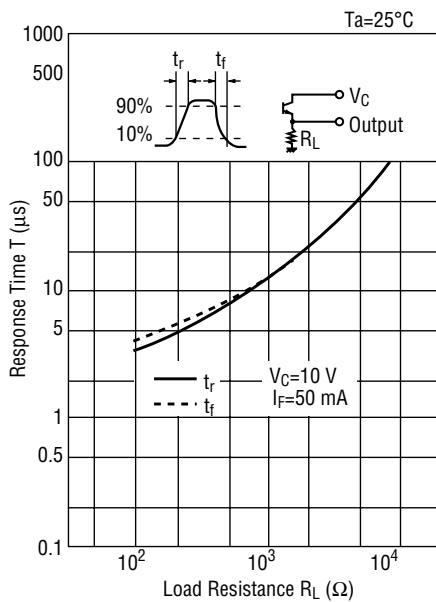

- OLD222CP—T54LCP Switching Time vs. Load Resistance

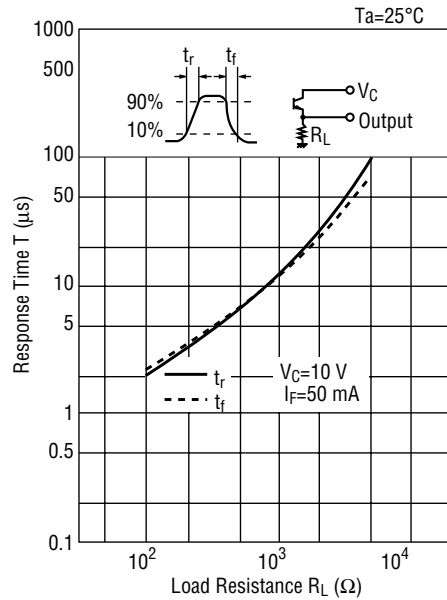

• OPU850CP—OPU860CP Switching Time vs. Load Resistance

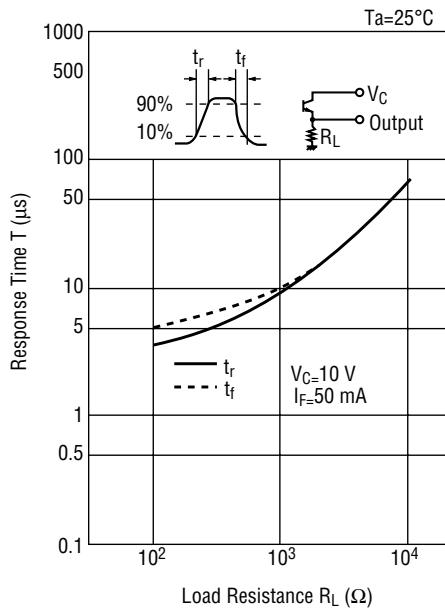

• OPU852CP—OPU860CP Switching Time vs. Load Resistance

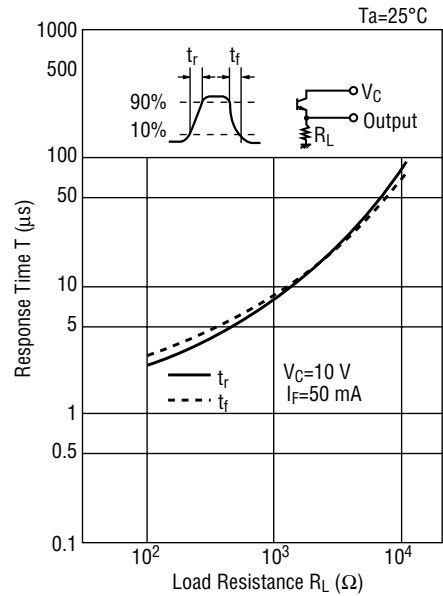

• OPU850CP—OPU862CP Switching Time vs. Load Resistance

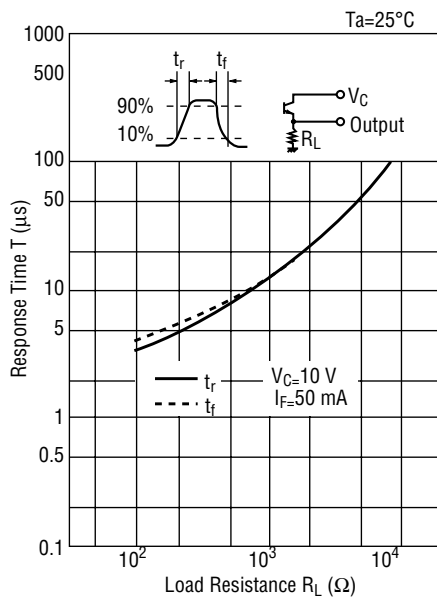

• OPU852CP—OPU862CP Switching Time vs. Load Resistance

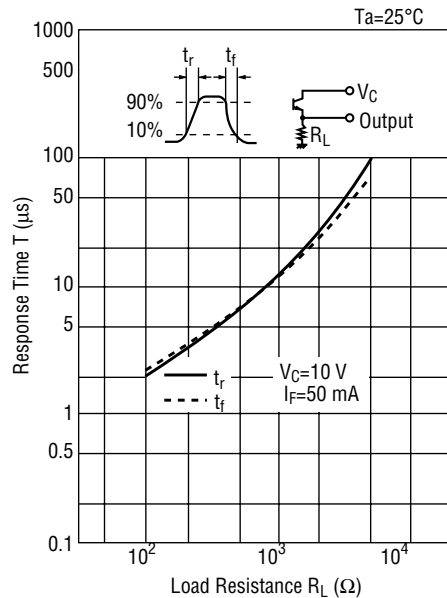

- OPU850CP-OPU852CP Maximum Pulse Forward Current Tolerance

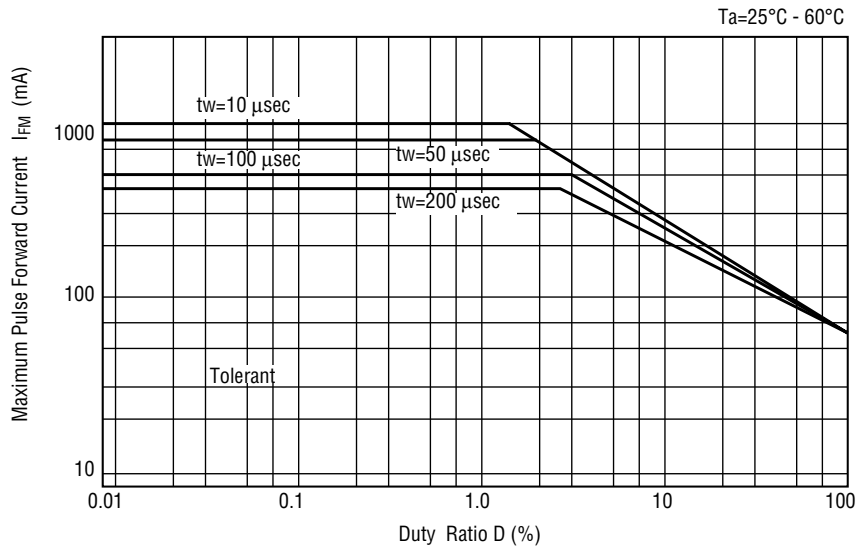

OPTION PARTS

• **Sensor Holder A Type Dimension**

(Unit: mm)

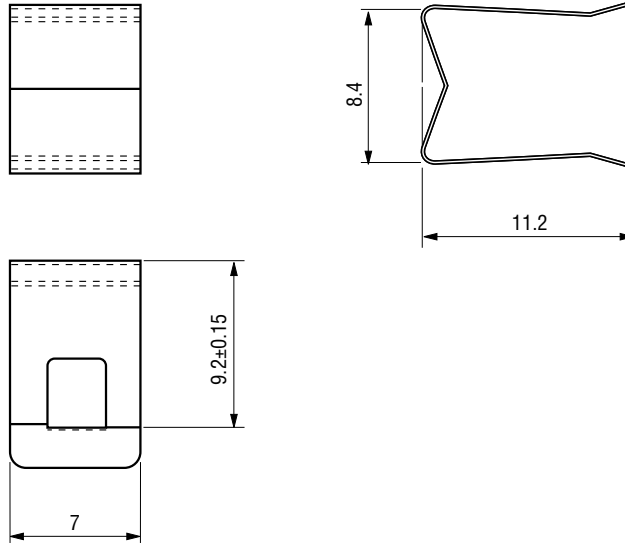

• **Sensor Holder B Type Dimension**

(Unit: mm)

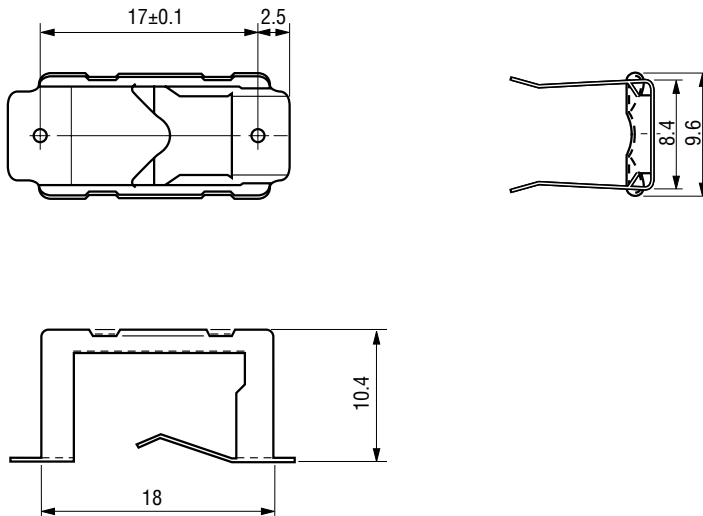

Recommended Connector for Capsule Sensor (female connector)

Product Name	Type	Maker
Connector	IL—Y—3S—S15C3	Japan Aviation Electronics Ind., Ltd.