

# 125 Series FTS250

## Disciplined Reference and Synchronous Clock Generator



2111 Comprehensive Drive  
Aurora, Illinois 60505  
Phone: 630-851-4722  
Fax: 630-851-5040  
[www.conwin.com](http://www.conwin.com)

# D A T A S H E E T

### General Description

The FTS250-010.0M Frequency and Time Standard module is a GPS driven, mixed-signal phase lock loop, providing a 1PPS CMOS output from a Connor-Winfield GPS timing receiver and generating a 10MHz CMOS and a 10MHz SINE output from an intrinsically low jitter voltage controlled crystal oscillator. The FTS250 can lock to a 10MHz reference derived from the on-board GPS receiver or an external 10MHz reference or to an external 1PPS reference. Alarms are provided to indicate Loss-of-Lock, Holdover, and Antenna Fault. The on-board GPS receiver requires an outdoor mounted GPS antenna for the best stability and consistent performance.

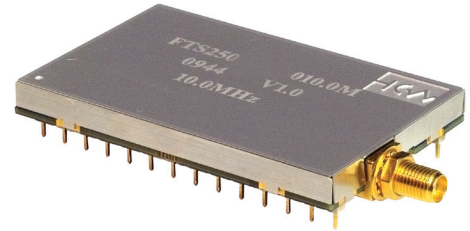

The mode control inputs are used to manually switch between references and/or holdover. The user application should monitor the alarm outputs and manually switch modes as needed.

Serial I/O lines provide access to the NMEA messages from the GPS receiver (referenced in the Connor-Winfield's Wi125 User Manual. Contact Connor-Winfield Sales for a copy). The serial I/O lines can be used to access GPS timestamp information, or to verify that the receiver has recovered from an alarm condition. The reset is used to reset the GPS receiver (if needed).

### Features

- Phase locked 10.0 MHz output
- 1 PPS output
- 3 selectable references: GPS, External 10MHz or External 1PPS
- Holdover
- Three alarm outputs. (Loss-of-Lock, Holdover and Antenna Fault)
- Serial input and output ports (GPS receiver)
- Master reset
- +3.3 Volt power supply
- Temperature Range: -40°C to 85°C
- Meets ITU-T G.811 Wander Generation Mask
- SMA Bulkhead GPS Antenna Connection
- Physical Dimensions: 2.8" x 1.725" x 0.368" (71mm x 43.82mm x 9.34mm)
- Fixed Position Unit

|           |                     |
|-----------|---------------------|
| Bulletin  | <b>SG176</b>        |
| Page      | <b>1 of 12</b>      |
| Revision  | <b>00</b>           |
| Date      | <b>14 June 2010</b> |
| Issued By | <b>ENG</b>          |

## Functional Block Diagram

Figure 1

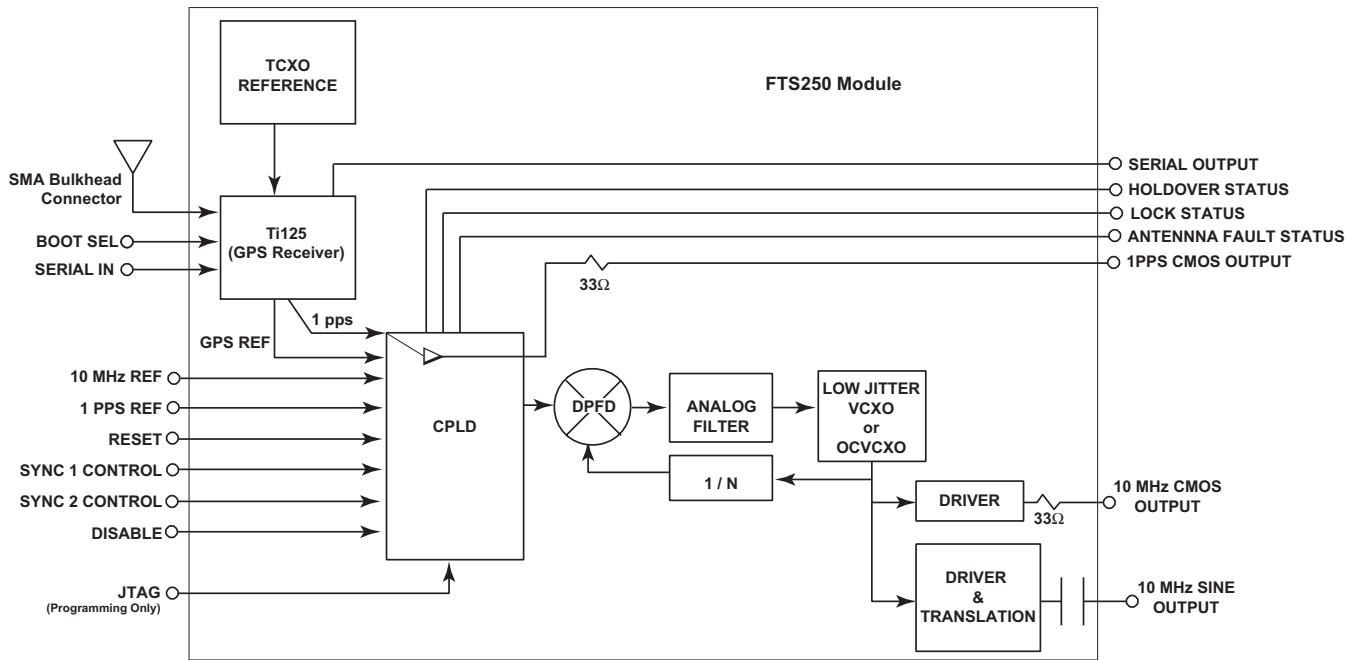

### Pin Description

Table 1

| Pin # | Pin Name               | Description  | Note |
|-------|------------------------|--|------|
| 1     | Vcc2                   | 3.3V ±5% Supply Voltage for PLL and Interfacing Circuitry                      | 1    |
| 2     | GND                    |  |      |
| 3     | *Reset                 | Hardware Reset for GPS Circuitry. Pull low to Reset                            | 2    |
| 4     | *Disable               | Open/High = Enabled Outputs. Low = Disabled Outputs                            | 2    |
| 5     | 1PPS Ref Input         | External 1PPS reference  | 2    |
| 6     | GND                    |  |      |
| 7     | 10MHz Ref Input        | External LVCMOS 10MHz Reference  | 2    |
| 8     | NU                     | Used for Factory Programming   |      |
| 9     | NU                     | Used for Factory Programming   |      |
| 10    | NU                     | Used for Factory Programming   |      |
| 11    | NU                     | Used for Factory Programming   |      |
| 12    | *Bootsel               | Normally High - Pulled low during CW25 software updates                        |      |
| 13    | GND                    |  |      |
| 14    | Vcc1                   | 3.3V ±5% Supply Voltage GPS Timing Circuitry                                   |      |
| 15    | Antenna Supply Voltage | 2.7 to 13.2V Input Supply Voltage for the Antenna. Max 45mA continuous current |      |
| 16    | GND                    |  |      |
| 17    | RXA                    | RS-232 Communication receive signal for UART-0                                 |      |
| 18    | TXA                    | RS-232 Communication transmit signal for UART-0                                |      |
| 19    | SYNC2 Control          | Lock mode selection control signal 2   | 2    |
| 20    | SYNC1 Control          | Lock mode selection control signal 1   | 2    |
| 21    | Lock Status            | High = Unit is locked to the selected reference                                | 2    |
| 22    | Holdover Status        | High = Unit is in Holdover   | 2    |
| 23    | Antenna Fault Status   | High = Fault detected on the Antenna Supply Voltage (Self Clearing)            | 2    |
| 24    | 1PPS CMOS Output       | 1PPS LVCMOS Output   | 2    |
| 25    | GND                    |  |      |
| 26    | 10MHz CMOS Output      | 10MHz LVCMOS Output  | 2    |
| 27    | GND                    |  |      |
| 28    | 10MHz SINE Output      | 10MHz Sine Output (~-9dBm)   |      |

Note: 1. Provide a clean supply to this pin. Connecting to Vcc1 will degrade phase noise.  
2. 3.3 VDC (LVCMOS) compatible.

## Absolute Maximum Rating

Table 2

| Symbol              | Parameter              | Minimum | Maximum | Units | Notes |
|---------------------|------------------------|---------|---------|-------|-------|
| V <sub>CC</sub>     | Power Supply Voltage   | -0.3    | 3.7     | Volts | 1     |
| V <sub>IN</sub>     | Input Voltage          | -0.3    | 4.6     | Volts | 1     |
| V <sub>PREAMP</sub> | Antenna Supply Voltage | 2.7     | 13.2    | Volts | 1     |
| T <sub>S</sub>      | Storage Temperature    | -30     | 80      | °C    | 1     |

## Operating Specifications

Table 3

| Symbol  | Parameter                       | Minimum      | Nominal     | Maximum | Units | Notes |
|---|---------------------------------|--------------|-------------|---------|-------|-------|
| V <sub>CC1</sub>                              | Supply Voltage 1                | 3.135        | 3.3         | 3.465   | V     | 2     |
| I <sub>CC1</sub>                              | Supply Current 1                |              | 0.200       |         | A     |       |
| V <sub>CC2</sub>                              | Supply Voltage 2                | 3.135        | 3.3         | 3.465   | V     | 2     |
| I <sub>CC2</sub>                              | Supply Current 2                |              | 0.036       |         | A     |       |
| T <sub>O</sub>                                | Temperature Range               | -40          |             | 85      | °C    |       |
| t <sub>JTOL</sub>                             | Input Jitter Tolerance          | 30           |             |         | ns    |       |
| t <sub>AQ_GPS</sub>                           | GPS Input Acquisition Time      |              | 100         |         | sec   | 3     |
| t <sub>AQ_EXT</sub>                           | External Input Acquisition Time |              | 100         |         | sec   | 3     |
| <b>Oscillator Performance</b>                 |                                 |              |             |         |       |       |
| F <sub>CAP</sub>                              | Capture/Pull-in Range           |              | ±10         |         | ppm   |       |
| F <sub>BW</sub>                               | Jitter Filter Bandwidth         |              | 0.8         |         | Hz    |       |
| DC  | Duty Cycle                      |              | 45/55       |         | %     |       |
| RMS   | RMS Phase Noise                 | 10Hz - 2MHz  | 1.2         |         | ps    |       |
|   |                                 | 12kHz - 2MHz | 0.6         |         |       |       |
| <b>Holdover/Wander Generation Performance</b> |                                 |              |             |         |       | 4     |
|   | Frequency Stability             |              | ±0.32       |         | ppm   | 5     |
|   | Wander Generation Specification |              | ITU-T G.811 |         |       |       |

**NOTES:**

1. Stresses beyond those listed under "Absolute Maximum Rating" may cause permanent damage to the module. These are stress ratings only and functional operation of the device at these or any other conditions beyond those indicated under "Operating Specifications" is not implied. Exposure to absolute maximum rated conditions for extended periods may affect device reliability.
2. Requires external regulation and supply decoupling
3. Cold Power-up
4. Holdover will be re-calculated with each successful lock. Yearly aging represents 1 continuous year in Holdover.
5. Includes unidirectional temperature stability, Vcc stability, and 24 hours of aging.

## Mode Control Table

Table 4

| SYNC 1 | SYNC 2 | Operating Mode                    |
|--------|--------|-----------------------------------|
| 0      | 0      | Force Holdover                    |
| 0      | 1      | Lock to External 10MHz reference* |
| 1      | 0      | Lock to External 1PPS reference   |
| 1      | 1      | (Default) Lock to GPS Signal      |

\*Note: Holdover is not supported in this mode; loss of the 10MHz reference will rail the PLL output until the reference returns or another mode is selected.

## Input And Output Characteristics

Table 5

### LVCMOS Inputs and Outputs

| Symbol          | Parameter                 | Minimum | Maximum | Units | Notes |
|-----------------|---------------------------|---------|---------|-------|-------|
| V <sub>IH</sub> | High Level Input Voltage  | 1.7     | 4.0     | V     |       |
| V <sub>IL</sub> | Low Level Input Voltage   | -0.5    | 0.8     | V     |       |
| V <sub>OH</sub> | High Level Output Voltage | 2.4     |         | V     |       |
| V <sub>OL</sub> | Low Level Output Voltage  |         | 0.4     | V     |       |
| C <sub>O</sub>  | Output Capacitance        |         | 10      | pF    |       |

### 10MHz Sine Output

| Symbol | Parameter                 | Typical | Units           | Notes |
|--------|---------------------------|---------|-----------------|-------|
|        | Load                      | 50      | ohms            |       |
|        | Output Power              | 9       | dB <sub>m</sub> |       |
|        | Total Harmonic Distortion | 2.2     | %               |       |

## GPS Receiver Specifications

Table 6

| Parameter                        | Specifications   | Notes |
|----------------------------------|--|-------|
| Acquisition/Tracking Sensitivity | -155dBm/-156dBm  |       |
| Acquisition Time:                |  |       |
| Hot Start w/ Network Assist      | Outdoor: <2 sec<br>Indoor(-148dBm) <5 sec  |       |
| Stand Alone                      | Cold <45 sec<br>Warm: <38 sec<br>Hot: <5 sec<br>Re-acquisition: <1sec (90% confidence) |       |
| Supported Protocols              | Network Assist, NMEA 0183  |       |

## Reset Generation (I/O pin 3 - RESET)

The power-on-reset for the FTS250 is generated on-board. If it is desired to extend the power-on-reset signal or provide a manual reset of the GPS receiver, pull this signal low.

## Antenna Requirements

Table 7

| Parameter   | Notes |
|---|-------|
| The FTS250 antenna connector is a SMA Bulkhead (female)   |       |
| The antenna supply voltage provided to Pin 15 must be within the range of 2.7 to 13.2V (AMR); the antenna must be able to operate at this voltage |       |
| The antenna's continuous current draw must be $\leq 45\text{mA}$  |       |
| The antenna must have a full sky view for optimal receiver performance  |       |
| An active antenna with a minimum 10dB gain (including cable loss) should be used  |       |

**Standard 125 Series models are designed for fixed position operation only. Contact Connor-Winfield Sales for mobile application model offerings**

## Phase Noise

Figure 2

| Phase Noise:          |            |
|-----------------------|------------|
| Offset Frequency (Hz) | (dBc/Hz)   |
| 10                    | -90 (Typ)  |
| 100                   | -125 (Typ) |
| 1k                    | -138 (Typ) |
| 10k                   | -142 (Typ) |
| 100k                  | -150 (Typ) |
| 1M                    | -152 (Typ) |

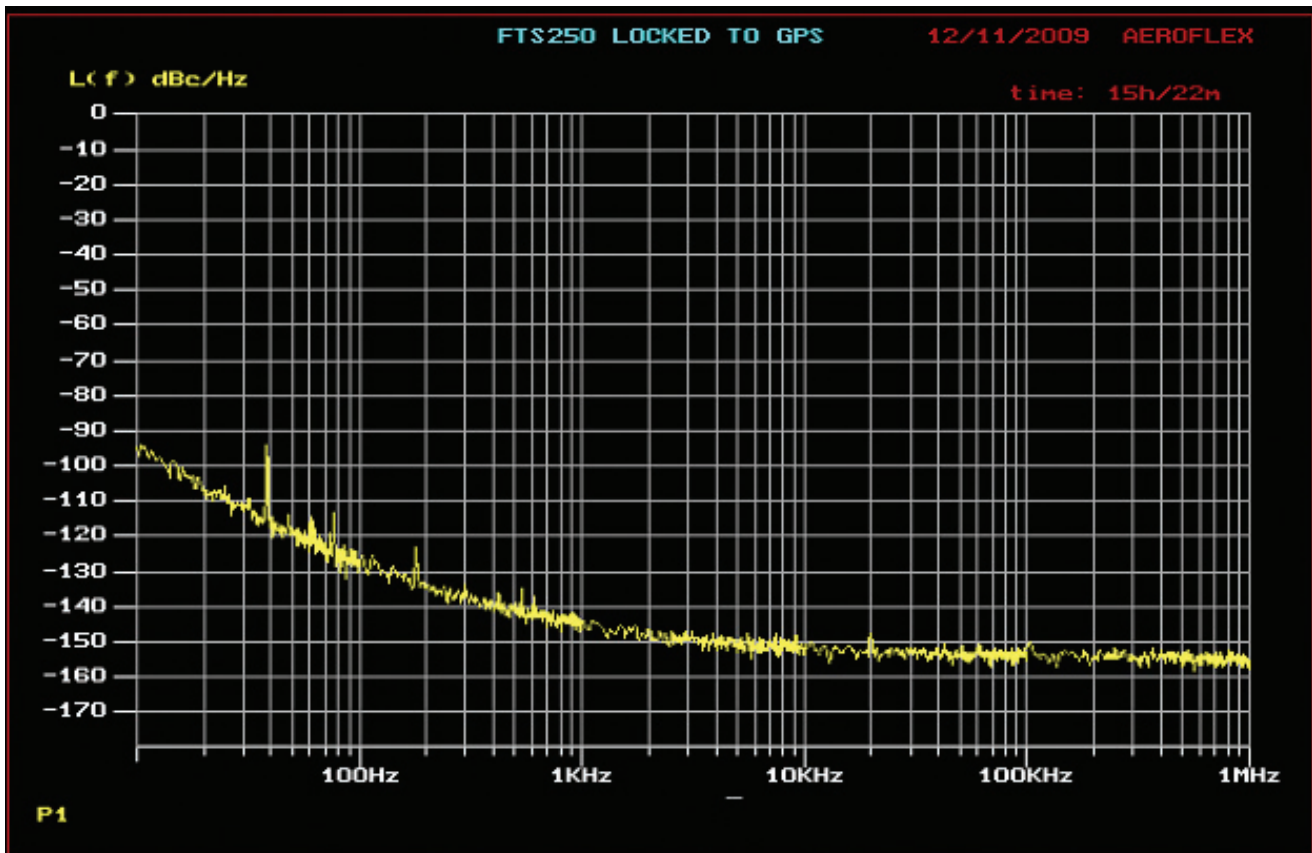

Allan Variance  
Figure 3

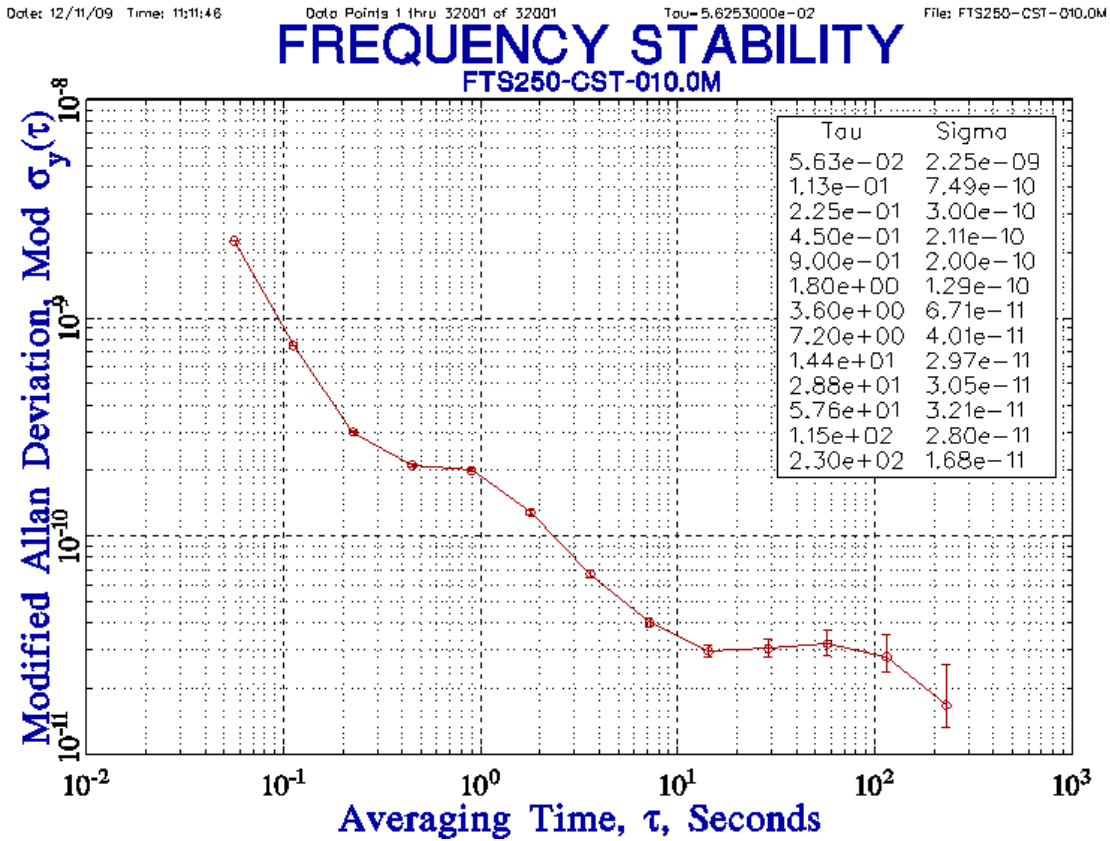

Wander Generation Plot – FTS250 versus G.811 Wander Generation Mask  
Figure 4

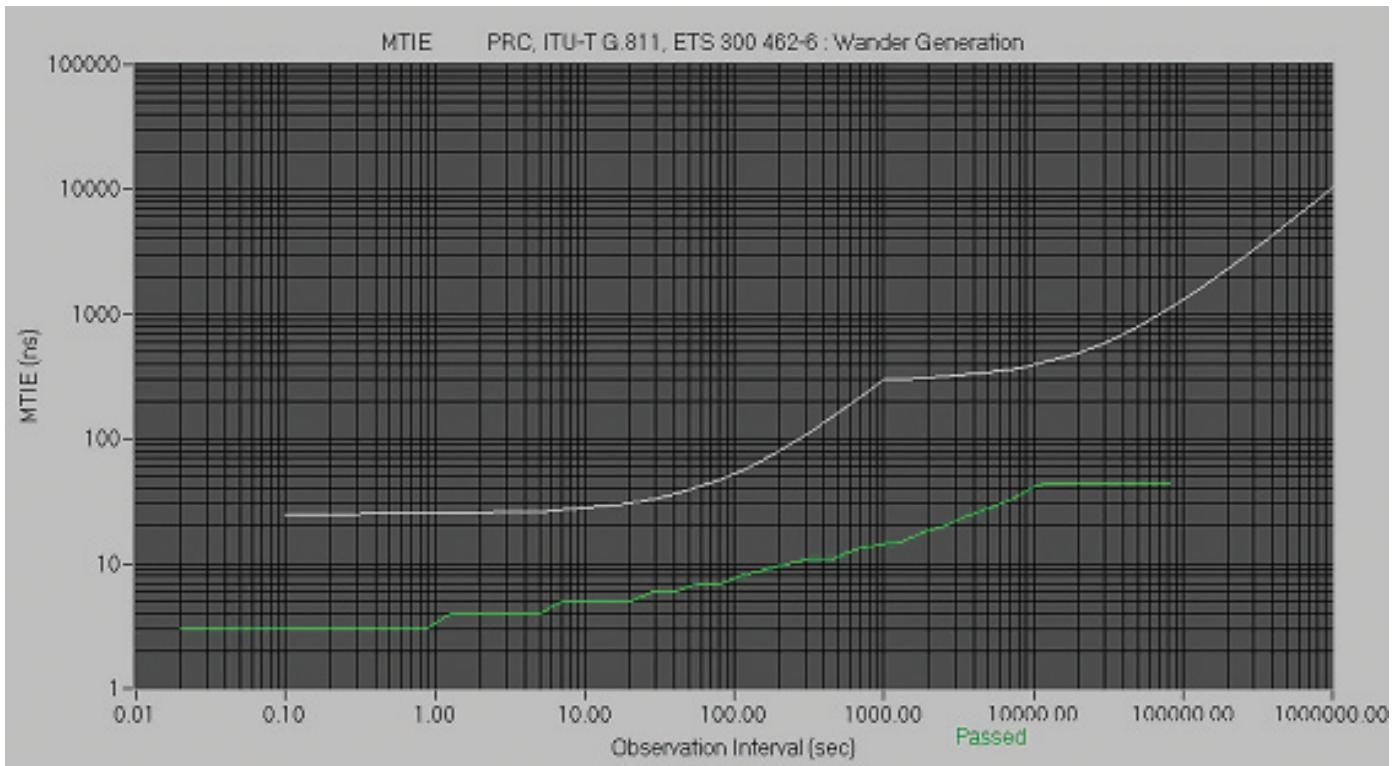

# Package Dimensions

Figure 5

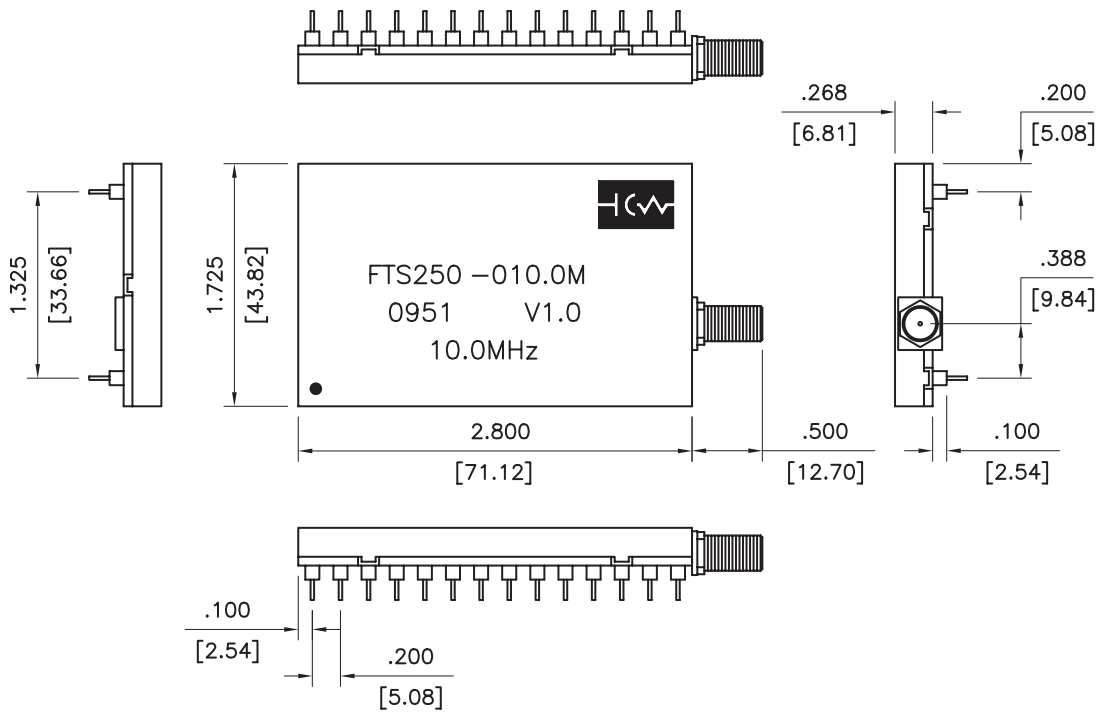

# Top View Dimensions & Keep-out Area

Figure 6

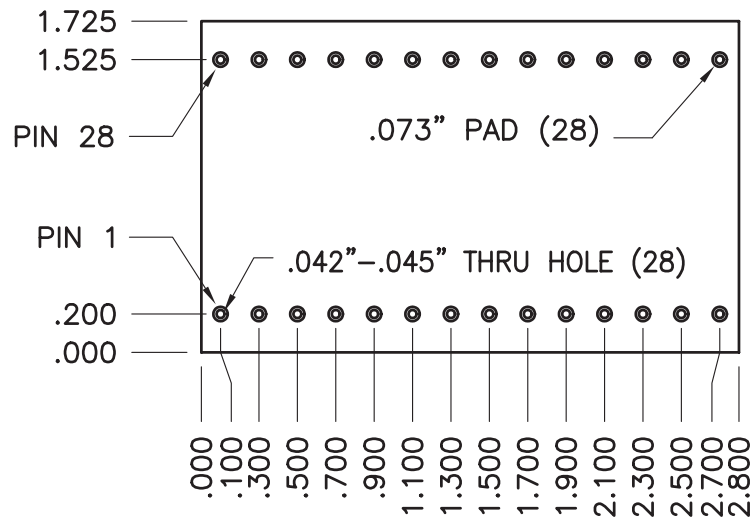



2111 Comprehensive Drive  
Aurora, Illinois 60505  
Phone: 630-851-4722  
Fax: 630-851-5040  
[www.conwin.com](http://www.conwin.com)

## Ordering Information

**Ex: FTS250-010.0M**

| Revision | Revision Date | Note                                     |
|----------|---------------|--|
| P00      | 01/19/10      | Preliminary Release                      |
| 00       | 06/14/10      | 125 Series Update and revised to release |