

Inlet filter, front side mounting, deeply placed circuit breaker TA45 2-pole

Standard- or Medical-Filter



new



C20



70° C



Description

- Panel Mount:
Screw-on from front side
- 3 Functions:
Inlet Protection class I, circuit breaker type TA45 2-pole, Line filter in standard and medical version
- Quick connect terminals 6.3 x 0.8 mm
- Alternative: version without line filter [EF11](#)

Approvals

- VDE License Number: 40001520
- UL License Number: E72928

Characteristics

- All single elements are already wired
- Line switch non-illuminated
Illuminated version on request
- Thermal overload protection
- Optional with undervoltage release or remote trip release
- With EMC-shield
- Qualified for use in equipment according IEC/EN 60950

References

[General Product Information](#)

Weblinks

Approvals: www.schurter.com/approvals
 RoHS: <http://www.schurter.com/rohs>
 CHINA-RoHS: www.schurter.com/china-rohs
 Webstore: www.schurterinc.com/estore/search.ihtml

Technical Data

Ratings IEC	12 - 16A @ Ta 40 °C / 250VAC; Hz 50	Appliance-Inlet /-Outlet	C20 acc. to IEC/EN 60320-1, UL 498, CSA C22.2 no. 42 (for cold condition) pin-temperature 70 °C, 16A, Protection class I
Ratings UL/CSA	12 - 20A @ Ta 40 °C / 125VAC; 60Hz	Circuit breaker	Acc. IEC/EN 60934, UL 1077, CSA 22.2 no. 235 2-pole rocker switch, illuminated or non-illuminated. Optional with undervoltage- or remote trip release Short circuit capacity I _{cn} : at I _n < 3A/240VAC : 10 x I _n at I _n ≥ 3A/240VAC : 300A
Leakage Current	standard < 0.5 mA (250 V / 60Hz) medical < 5 µA (250 V / 60 Hz)	Line Switch	Rocker switch 2-pole, non-illuminated or illuminated, acc. to IEC 61058-1 Technical details
Dielectric Strength	> 1.7 kVDC between L-N > 2.7 kVDC between L/N-PE Test voltage (2 sec)	Line Filter	Standard and Medical Version, IEC 60939, IEC 60601-1, UL 1283, UL 544, EN 133 200, CSA C22.2 no. 8 Technical details
Allowable Operation Temp.	-10°C to 55 °C	MTBF	> 100'000h acc. to MIL-HB-217 F
Climatic Category	10/055/21 acc. to IEC 60068-1		
Degree of Protection	from front side IP 40 acc. to IEC 60529		
Protection Class	Suitable for appliances with protection class I acc. to IEC 61140		
Terminal	Quick connect terminals 6.3 x 0.8 mm		
Panel Thickness s	Screw-on: max 8mm Mounting screw torque max 0.5Nm		
Material: Housing	Thermoplastic, black, UL 94V-0		

Dimensions

Length |-----| 59.5 mm

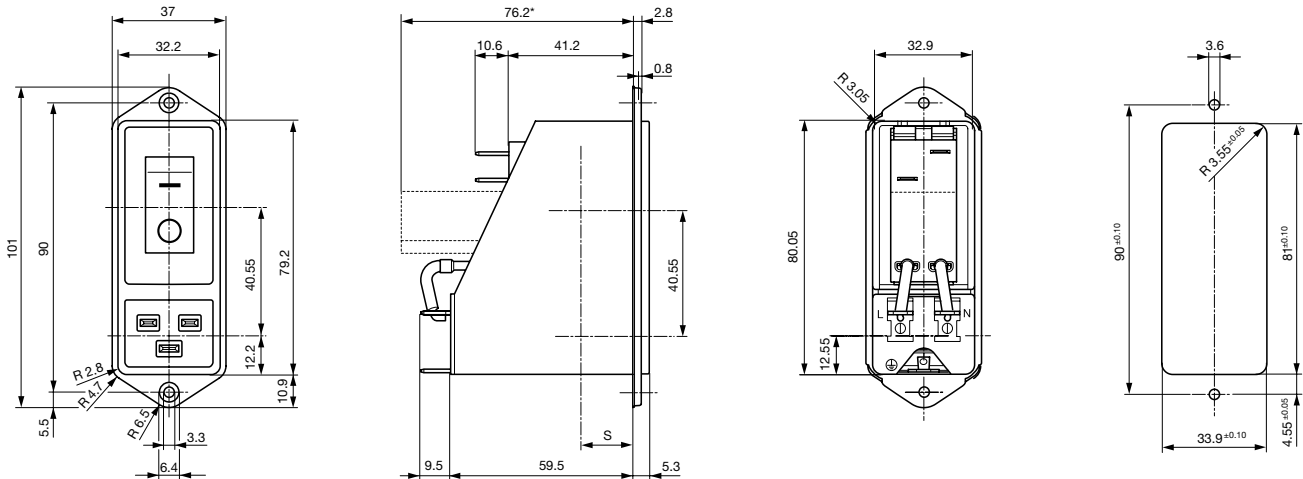

* --- Version TA45 with undervoltage release

Technical Data of Filter-Components

Rated Current [A]	Filter-Type	Inductances L [mH]	Capacitance CX [nF]	Capacitance CY [nF]	R [MΩ]
12	Standard Version	2 x 0.8	100	2.2	1
16	Standard Version	2 x 0.6	100	2.2	1
20	Standard Version	2 x 0.3	100	2.2	1
12	Medical Version (M5)	2 x 0.8	100	-	1
16	Medical Version (M5)	2 x 0.6	100	-	1
20	Medical Version (M5)	2 x 0.3	100	-	1

Diagrams

Standard version

Medical version

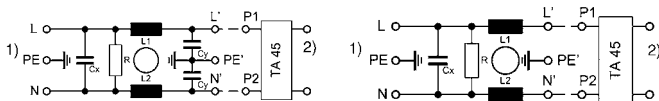

1) Line
2) Load

1) Line
2) Load

Attenuation Loss

----- differential mode ____ common mode

Standard version

12 A

16 A

20 A

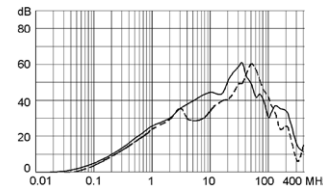
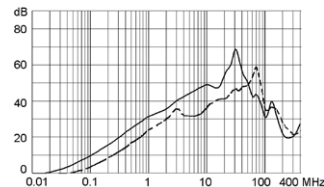
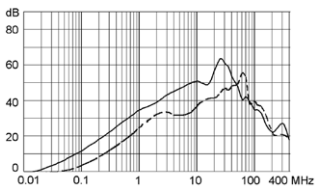

Medical version (M5)

12 A

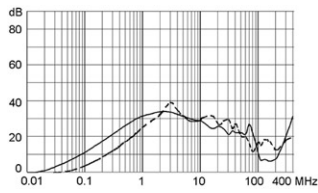

16 A

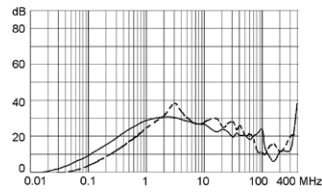

20 A

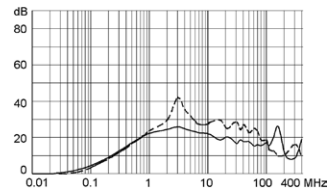

Packaging unit 16 Pcs

Accessory

Description

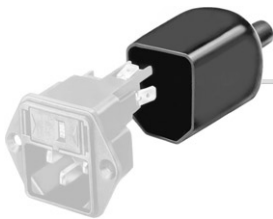

Assorted Covers
Rear Cover



Cord retaining kits
Cord retaining strain relieve

Table 1 Selection for type TA45

Order example



- Line switch
 - 2-pole, rocker actuated
 - Quick connect terminal
- Other types on request

ABT **W** **F** **150** **C0**

Diagram

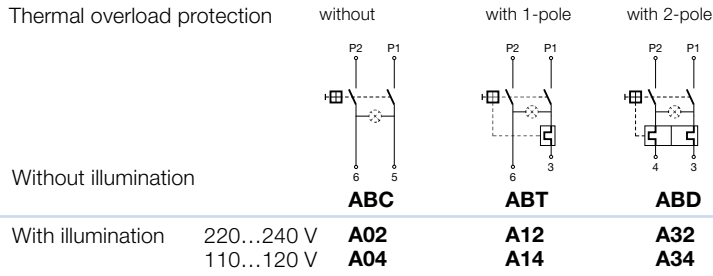

Colours

Switch front	Rocker	
W black	white	—
B black	black	—
6 black	—	orange transp.

Rocker legend

Surface	Illustration	Colour of print	Surface	Illustration	Colour of print
F embossed	— ○		M printed	— ○	black
H printed	ON OFF	white	P printed	I ○	white
K printed	ON OFF	black	R printed	I ○	black
L printed	— ○	white			

Position of the rocker legend
e.g F

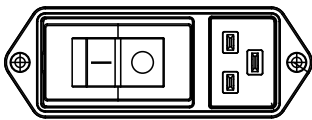

Rated current:

- Without thermal overload protection: code **C00** } $I_n = 20\text{ A}$
- With thermal overload protection: rated current I_n (A)

I_n	Code	I_n	Code	I_n	Code	I_n	Code
10,0	100	13,0	130	16,0	160	19,0	190
11,0	110	14,0	140	17,0	170	20,0	200
12,0	120	15,0	150	18,0	180		

Other rated currents on request

Without release: code C0

Undervoltage release

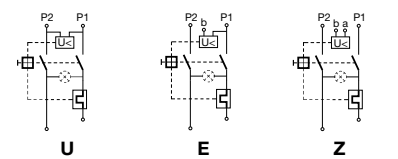

•	•	•
•	•	•
•	•	•

Remote trip release



•	2	240 V AC
•	3	230 V AC
•	4	120 V AC

Technical data (continued)

Circuit breaker

Tripping characteristics

$I_n < 3 A$

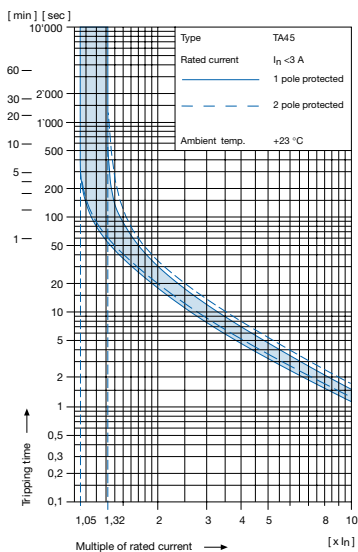

Tripping characteristics

$I_n \ge 3... < 18 A$

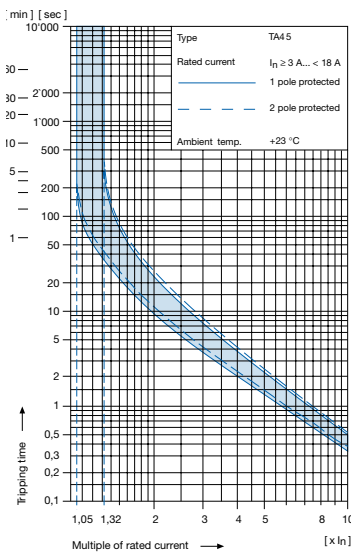

Tripping characteristics

$I_n \ge 18 A$

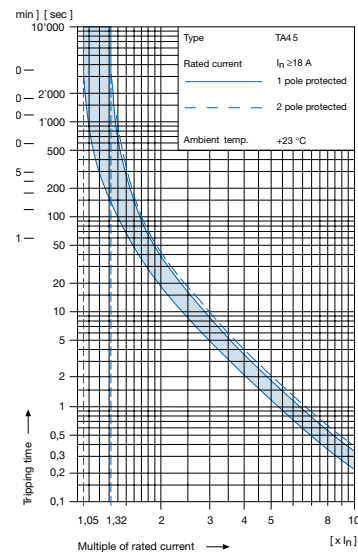

1) Effect of ambient temperature

The unit is calibrated for an ambient temperature of +23 °C. To determine the rated current for a lower or higher ambient temperature, use a correction factor from the table on the right side:

* Ambient temperature [°C]	Correction factor
-10	0,89
-5	0,91
0	0,92
+23	1,00
+30	1,03
+40	1,08
+55	1,16

* Temperature must be measured at the rear of the breaker next to the terminals after equipment operating temperature has been reached.

1) Example

Rated current at +23 °C	6,0 A
Ambient temperature	+40 °C
Correction factor	1,08
Chosen rated current at +40 °C ambient temperature	6 A x 1,08 = 6,5 A

Order code for EF12 (order example)

Type	Order code TA45 (2-pole rocker-switch without accessories)
EF12.	A B T W F 1 5 0 C 0 . see table 1
	11 10.01

Please note that Schurter will establish an internal new part number for logistical use in addition to the order code. The format of this internal part number is, for example EF12.xxxx.1110.01

Application note

The rated current of the line filter must be equal or higher than the rated current of the circuit-breaker

Other versions on request

- Rocker switch illuminated

- Wiring**
1 = wired
- Protection class**
0 = Class I, housing black
- Panel mount**
0 = Screw-on version
- Terminals**
1 = Quick connect terminals 6,3 x 0,8 mm
- Line filter version**
1 = standard
2 = medical
- Line filter, rated current**
1 = 20 A, 2 = 16 A, 3 = 12 A